

NEELSSON MOBILIEAR

INDICE



01 COIFFEUSES POSTI LAVORO
STYLING UNITS TOCADORES
FRISIERPLÄTZE

02 HOMME UOMO
MAN HOMBRE MANN

03 FAUTEUILS POLTRONE
CHAIRS SILLONES STÜHLE

04 BACS DE LAVAGE LAVAGGI
WASH UNITS LAVACABEZAS
WASCHSESSEL

05 ACCUEIL RECEPTIONS
RECEPTION DESKS RECEPCIONES
THEKEN

06 CHAUFFEUSES DIVANI
RECEPTION SEATING SILLONES
DE ESPERA WARTESESSEL

07 CHARIOTS CARRELLI
TROLLEYS CARROS
SERVICEWAGEN

08 ESTHETIQUE ESTETICA BEAUTY
ESTÉTICA ÄSTHETIK

09 MEUBLES MOBILI
FURNITURE MUEBLES
MÖBEL

10 ACCESSOIRES ACCESSORI
ACCESSORIES ACCESORIOS
ZUBEHÖRTEILE

11 COLORIS COLORI
COLORS COLORES FARBEN

COLLECTION
2 0 2 2

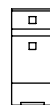
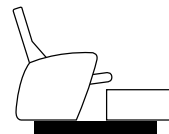
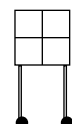
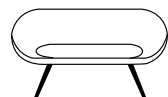
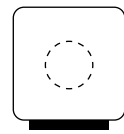
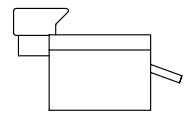
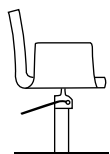
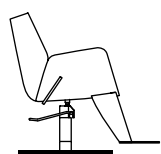
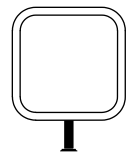

01

COIFFEUSES

POSTI LAVORO

STYLING UNITS

TOCADORES

FRISIERPLÄTZE



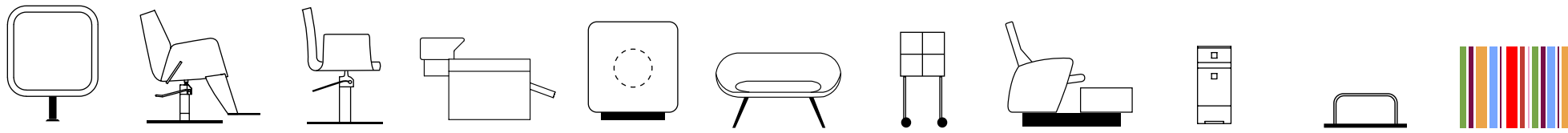

SCAMNUM CARRÉ OR / NOIR

SCAMNUM CARRÉ OR / NOIR FF 270COR / FF 270CNO

€ 1.349,00

- Coiffeuse avec structure métallique noire et tablette en stratifié coloris laiton satiné. Miroir carré avec cadre en PVC or ou noire polie. Avec repose-pieds.
- Posto di lavoro con struttura in metallo colore nero e ripiano in laminato finitura ottone satinato. Specchio quadrato con cornice in pvc finitura oro o nero lucido. Con poggiapiedi.
- Styling unit with black metal structure and laminate shelf with satin brass finish. Square mirror with frame in vinyl resin in polished brass gold or gloss black finish. Footrest included.
- Puesto de trabajo con estructura metálica negra y balda laminada con acabado en latón satinado. Espejo cuadrado con marco de pvc con acabado latón o negro brillante. Con reposapiés.
- Styling-Einheit mit schwarzer Metallstruktur und Laminatregal mit satiniertem Messingfinish. Quadratischer Spiegel mit Rahmen aus PVC-Messing oder schwarz glänzendem Finish. Mit Fußstütze.

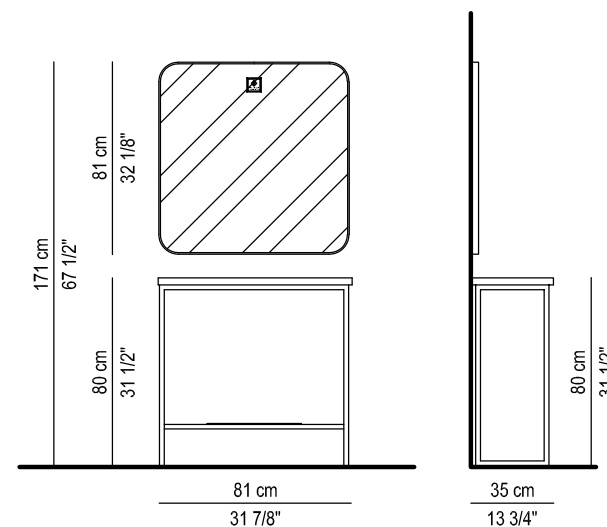

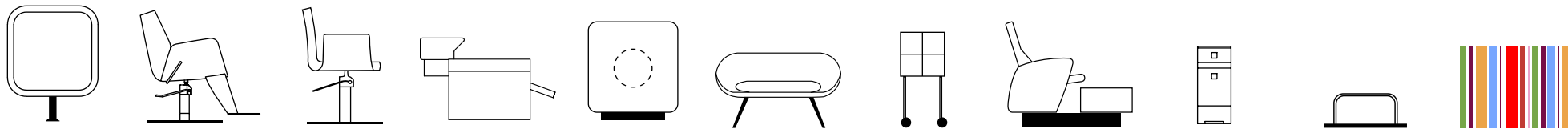

SCAMNUM RONDE OR / NOIR

SCAMNUM RONDE OR / NOIR FF 270ROR / FF 270RNO

€ 1.349,00

- Coiffeuse avec structure métallique noire et tablette en stratifié coloris laiton satiné. Miroir rond avec cadre en PVC or ou noire polie. Avec repose-pieds.
- Posto di lavoro con struttura in metallo colore nero e ripiano in laminato finitura ottone satinato. Specchio rotondo con cornice in pvc finitura oro o nero lucido. Con poggiapiedi.
- Styling unit with black metal structure and laminate shelf with satin brass finish. Round mirror with frame in vinyl resin with polished brass gold or gloss black finish. Footrest included.
- Puesto de trabajo con estructura de metal negro y balda laminada con acabado en latón satinado. Espejo redondo con marco de pvc con acabado en latón o negro brillante. Con reposapiés.
- Styling-Einheit mit schwarzer Metallstruktur und Laminatregal mit satiniertem Messingfinish. Runder Spiegel mit Rahmen aus PVC-Messing oder glänzendem Schwarz. Mit Fußstütze.

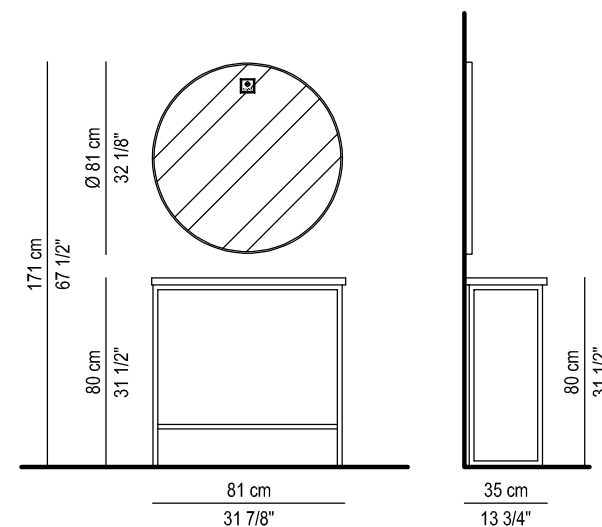

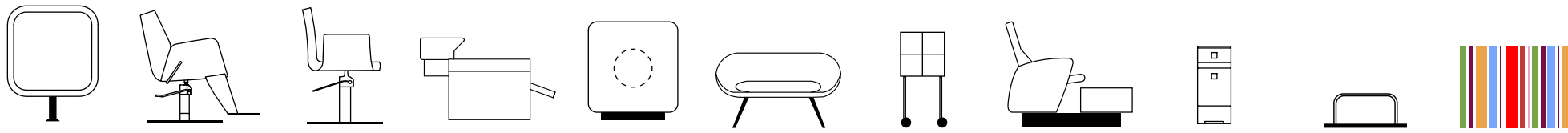

MIROIR SEUL



MIROIR CARRE SEUL OR / NOIR

FF 270MIRCOR / FF 270MIRCNO

€ 525,00

- Miroir en forme carré avec le cadre pvc en finition or brillant ou noir brillant.
- Specchio sagomato con telaio finitura pvc lucido oro o nero.
- Square mirror with pvc frame in gloss gold or gloss black finish.
- Tocadore en forma cuadrada con marco de pvc en acabado oro brillo o negro brillo.
- Spiegel in quadratischer Form mit PVC-Rahmen in glänzendem Gold oder glänzendem Schwarz.

MIROIR ROND SEUL OR / NOIR

FF270MIRROR / FF270MIRRNO

€ 525,00

- Miroir en forme rond avec le cadre pvc en finition or brillant ou noir brillant.
- Specchio sagomato con telaio finitura pvc lucido oro o nero.
- Round mirror with pvc frame in gloss gold or gloss black finish.
- Tocadore en forma redonda con marco de pvc en acabado oro brillo o negro brillo.
- Spiegel in runder Form mit PVC-Rahmen in glänzendem Gold oder glänzendem Schwarz.

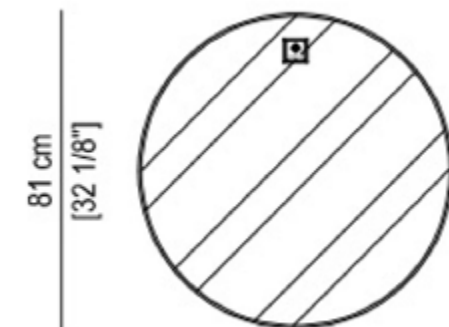
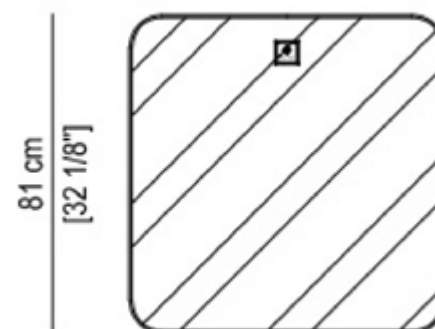

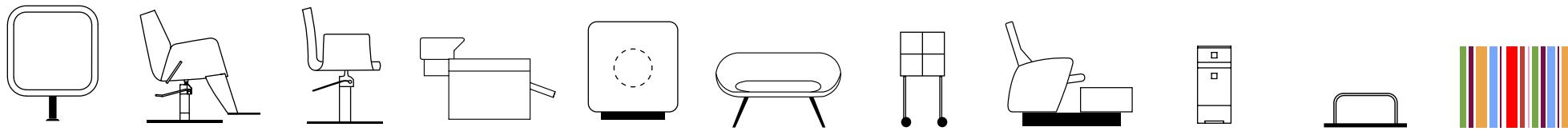

BAR MIROIR CARRE

BAR MIROIR CARRE NOIR / OR

€ 2.006,00

FF 270BARCNO / FF 270BARCOR

- Coiffeuse murale 2 places en stratifié Noir Luxe T15, 4 prises électriques intégrées. - Miroir en forme carré avec le cadre pvc en finition or brillant ou noir brillant.
- Posto di lavoro parete 2 posti struttura in nobilitato T15 Noir Luxe lucido completo di 4 prese elettriche. Specchio sagomato con telaio finitura pvc lucido oro e nero senza appoggia piedi.
- 2 seater wall styling unit in black gloss laminate (Noir Luxe T15) with 4 integrated sockets. Square mirror with pvc frame in gloss gold or gloss black finish
- Tocador 2 puestos en estratificado Noir Luxe T15. 4 tomas integradas. Tocadore en forma cuadrada con marco de pvc en acabado oro brillo o negro brillo.
- Wand-Frisiertisch 2 Plätze. Laminat schwarz glänzend (Noir Lux T15) 4 integrierten Steckdosen. Spiegel in quadratischer Form mit PVC-Rahmen in glänzendem Gold oder glänzendem Schwarz.

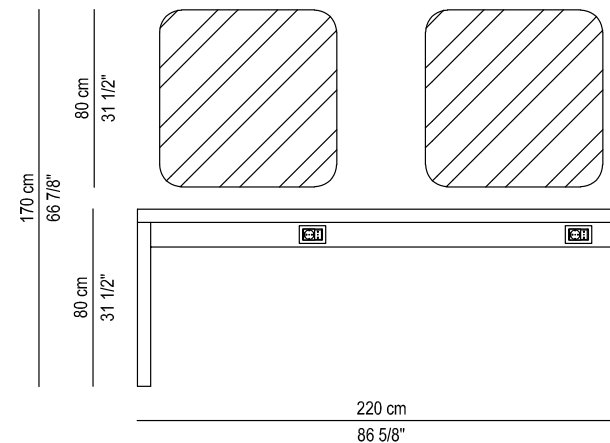

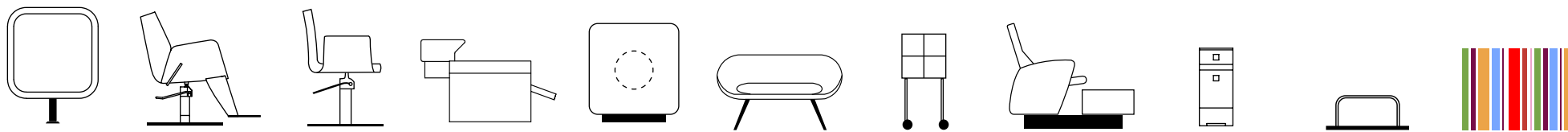

BAR MIROIR ROND

BAR MIROIR ROND NOIR / OR

€ 2.006,00

FF 270BARRNO / FF 270BARROR

- Coiffeuse murale 2 place en stratifié Noir Luxe T15 avec 4 prises électriques intégrées. - Miroir en forme rond avec le cadre pvc en finition or brillant ou noir brillant.
- Posto di lavoro parete 2 posti struttura in nobilitato T15 Noir Luxe lucido completo di 4 prese elettriche. Specchio sagomato con telaio finitura pvc lucido oro e nero.
- 2 seater wall styling unit in black gloss laminate (Noir Luxe T15) with 4 integrated sockets. Round mirror with pvc frame in gloss gold or gloss black finish.
- Tocador 2 puestos en estratificado Noir Luxe T15. 4 tomas integradas. Tocadore en forma redonda con marco de pvc en acabado oro brillo o negro brillo.
- Wand-Frisiertisch 2 Plätze in laminat schwarz glänzend (Noir Lux T15) 4 integrierten Steckdosen. Spiegel in runder Form mit PVC-Rahmen in glänzendem Gold oder glänzendem Schwarz.

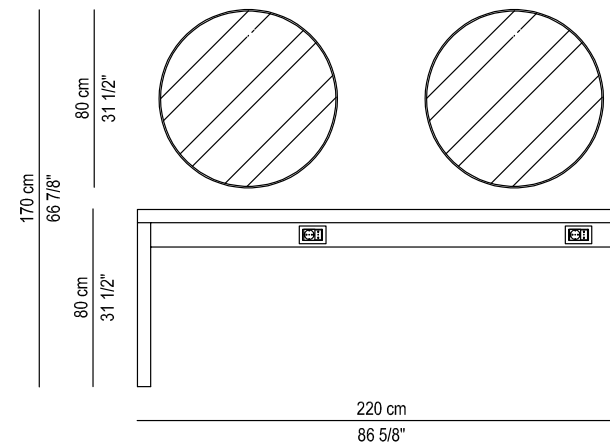

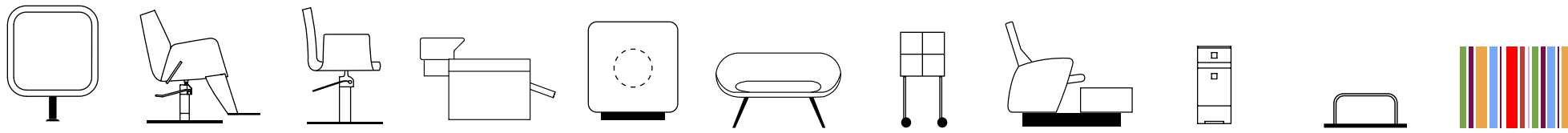

OVALIS DOUBLE OR/NOIR

OVALIS DOUBLE OR/NOIR

FF 282OR / FF 280NO

€ 3.300,00

- Coiffeuse centrale 2 places avec cadre PVC en laiton brillant et tablette et base en inox, équipée de 4 prises électriques. Sans repose pieds.
- Posto di lavoro centrale 2 posti con cornice in pvc finitura oro lucido e ripiano e base in metallo inox, completo di 4 prese elettriche. Senza poggiatesta.
- 2 position island styling unit with mirror frame in vinyl resin with a polished brass gold finish, and polished stainless steel shelf and metal base. Equipped with 4 integrated sockets. Footrests not included.
- Tocador central doble con estructura de PVC con acabado latón y repisa y base de metal, con 4 enchufes. Sin reposapiés.
- Zentraler Frisiertisch 2 Plätze mit PVC-Rahmen mit Messing Finish und Ablage und Base Metal. Mit 4 Steckdosen. Ohne Fußstütze.

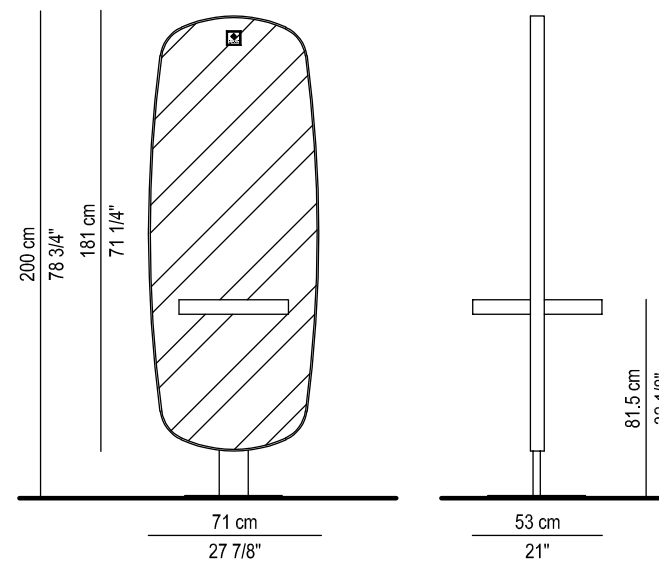

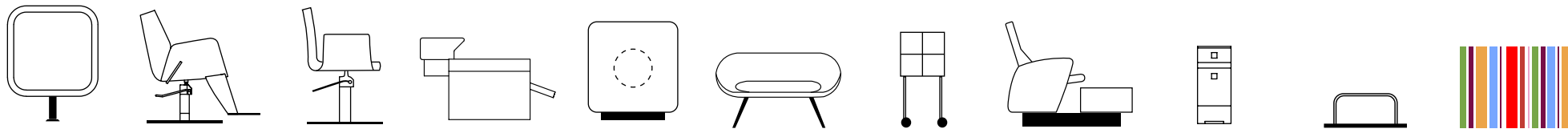

OVALIS OR/NOIR

OVALIS OR/NOIR

FF 2800R / FF 280NO

€ 1.166,00

- Coiffeuse avec tablette en inox. Cadre PVC en laiton ou noir brillant. Sans repose-pieds.
- Posto di lavoro con ripiano in acciaio inox. Cornice in pvc finitura oro o nero lucido. Senza poggiapiedi.
- Styling unit with stainless steel shelf and frame in vinyl resin with a polished brass gold or gloss black finish. Without footrest.
- Puesto de trabajo con repisa de acero inoxidable. Estructura de pvc con acabado latón o negro brillante. Sin reposapiés.
- Arbeitsplatz mit Edelstahlregal. PVC-Rahmen mit Messing oder schwarz glänzendem Finish. Ohne Fußstütze.

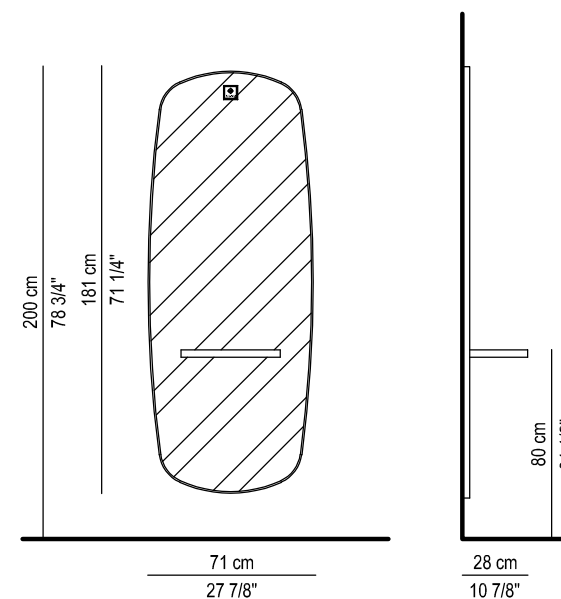



RECTANGULUM OR/NOIR

RECTANGULUM OR/NOIR

FF 2900R / FF 290NO

€ 1.050,00

- Coiffeuse avec tablette en métal noir mat. Cadre PVC en laiton ou noir brillant. Sans repose-pieds.
- Posto di lavoro con ripiano in metallo verniciato nero. Cornice in pvc finitura oro o nero lucido. Senza poggiapiedi.
- Styling unit with black painted metal shelf and frame with brass or glossy black pvc finish. Without footrest.
- Puesto de trabajo con repisa de metal pintado de negro. Estructura de pvc con acabado latón o negro brillante. Sin reposapiés.
- Arbeitsplatz mit schwarz lackiertem Metallregal. PVC-Rahmen mit Messing oder schwarz glänzendem Finish. Ohne Fußstütze.

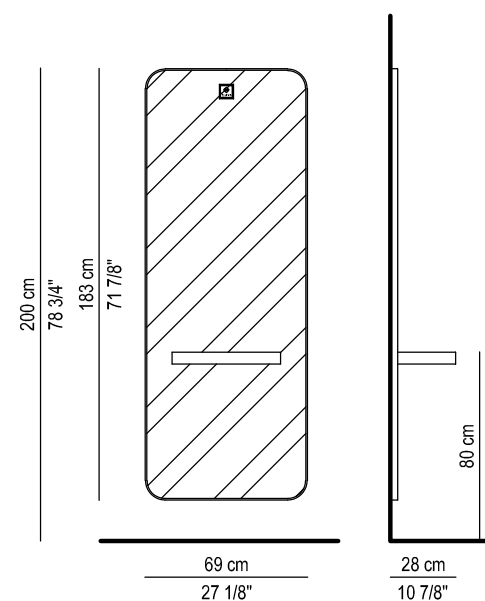

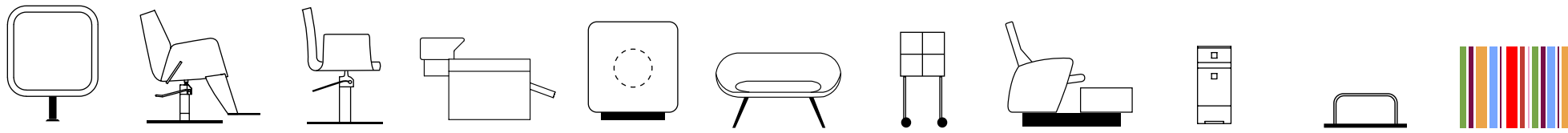

GRAPHOS

GRAPHOS FF 2200

€ 1.255,00

- Coiffeuse avec tablette en inox. Cadre en menuiserie MDF revêtement PVC argent mat et poli. Sans repose-pieds.
- Posto di lavoro con ripiano in acciaio inox. Cornice sagomata in mdf rivestita in pvc con decoro argento opaco e lucido. Senza poggiapiedi.
- Styling unit with stainless steel shelf and moulded MDF frame in a matt and glossy silver decoration. Without footrest.
- Puesto de trabajo con repisa de acero inoxidable. Marco perfilado en mdf revestido en pvc con decoración plateada mate y brillante. Sin reposapiés.
- Styling-Einheit mit Edelstahlregal und geformtem MDF-Rahmen in einer matten und glänzenden Silberdekoration. Ohne Fußstütze.

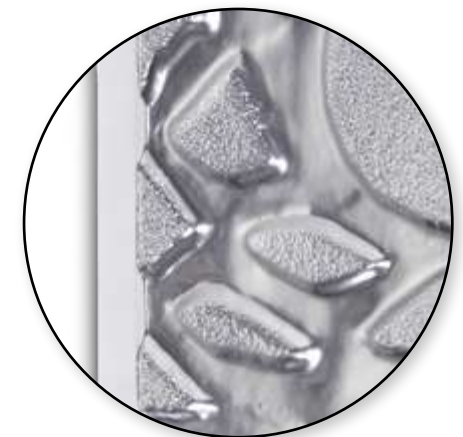
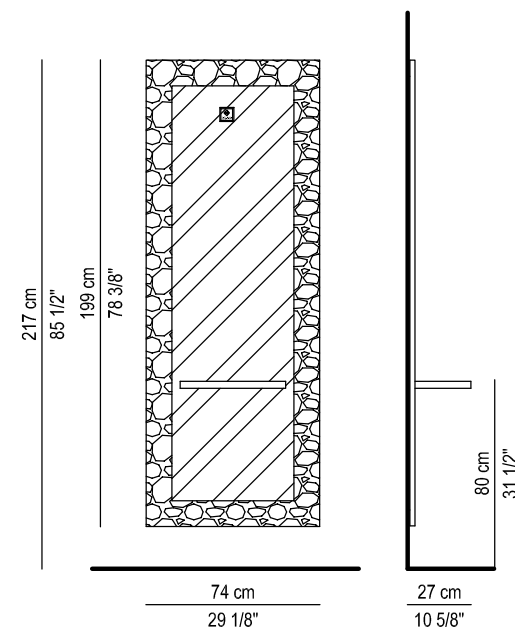

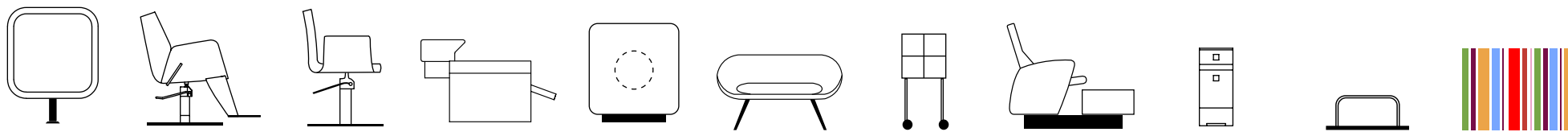

GRAPHOS BAR

GRAPHOS BAR

FF 2200BAR

€ 2.510,00



- Coiffeuse murale 2 places en stratifié Noir Luxe T15, 4 prises électriques intégrées. Cadre en menuiserie MDF revêtement PVC argent mat et poli. Sans repose-pieds.
- Posto di lavoro parete 2 posti struttura in nobilitato T15 Noir Luxe lucido completo di 4 prese elettriche. Cornice sagomata in mdf rivestita in pvc con decoro argento opaco e lucido, senza appoggia piedi.
- 2 seater wall styling unit in black gloss laminate (Noir Luxe T15) with 4 integrated sockets. Moulded MDF frame with a matt and glossy silver decoration. Without footrest.
- Tocador 2 puestos en estratificado Noir Luxe T15. 4 tomas integradas. Marco perfilado en mdf revestido en pvc con decoración plateada mate y brillante. Sin reposapiés.
- Wand-Frisiertisch 2 Plätze in Laminat schwarz glänzend (Noir Lux T15) 4 integrierten Steckdosen. geformtem MDF-Rahmen in einer matten und glänzenden Silberdekoration. Ohne Fußstütze

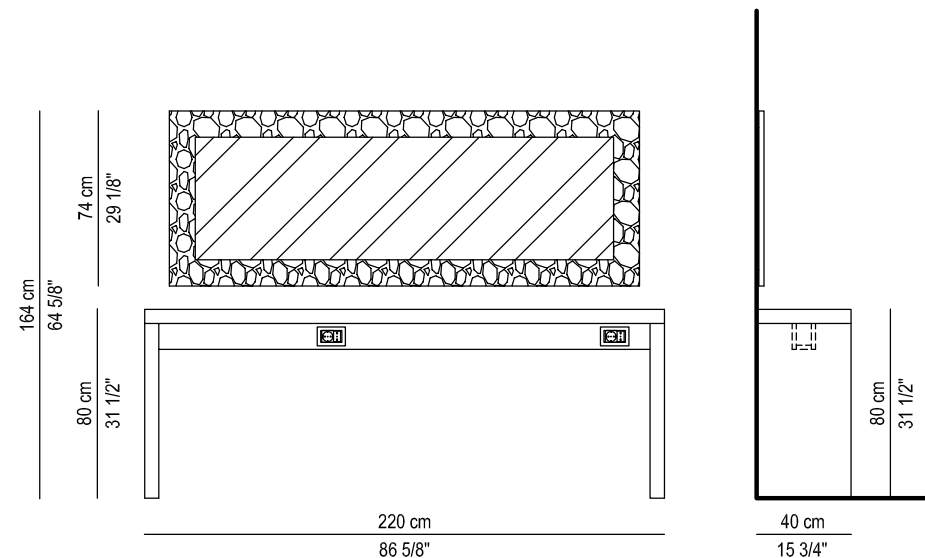

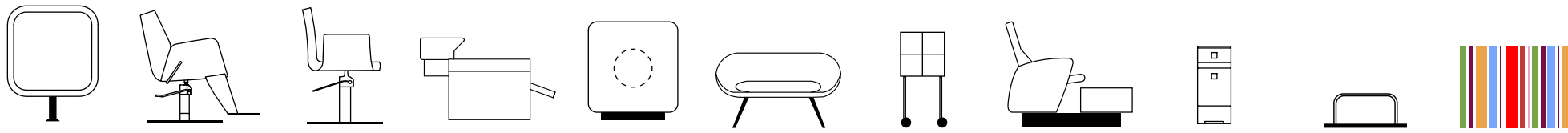

DECÒ

DECÒ FF 2210

€ 1.281,00

- Coiffeuse avec tablette en inox. Cadre en menuiserie MDF revêtement PVC noir mat. Sans repose-pieds.
- Posto di lavoro con ripiano in acciaio inox. Cornice sagomata in mdf rivestita in pvc con decorazioni nero opaco. Senza poggiapiedi.
- Styling unit with stainless steel shelf and moulded MDF frame with matt black decoration. Without footrest.
- Puesto de trabajo con repisa de acero inoxidable. Estructura moldeada en mdf revestida en pvc con adornos negros mate. Sin reposapiés.
- Arbeitsplatz mit Edelstahlregal. Geformter Rahmen in MDF, bedeckt in PVC mit mattschwarzen Verzierungen. Ohne Fußstütze.

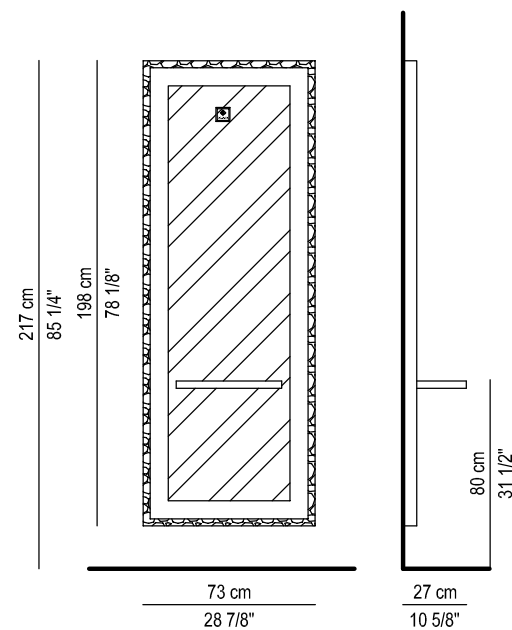

DECÒ BAR

DECÒ BAR FF 2210BAR

€ 2.531,00

- Coiffeuse murale 2 places en stratifié Noir Luxe T15, 4 prises électriques intégrées. Cadre en menuiserie MDF revêtement PVC noir mat. Sans repose-pieds.
- Posto di lavoro parete 2 posti struttura in nobilitato T15 Noir Luxe lucido completo di 4 prese elettriche. Cornice sagomata in mdf rivestita in pvc con decoro nero opaco, senza appoggia piedi.
- 2 seater wall styling unit in black gloss laminate (Noir Luxe T15) with 4 integrated sockets. Moulded MDF frame with matt black decoration. Without footrest.
- Tocador 2 puestos en estratificado Noir Luxe T15. 4 tomas integradas. Estructura moldeada en mdf revestida en pvc con adornos negros mate. Sin reposapiés.
- Wand-Frisiertisch 2 Plätze. Laminat schwarz glänzend (Noir Lux T15) 4 integrierten Steckdosen. Geformter Rahmen in MDF, bedeckt in PVC mit mattschwarzen Verzierungen. Ohne Fußstütze

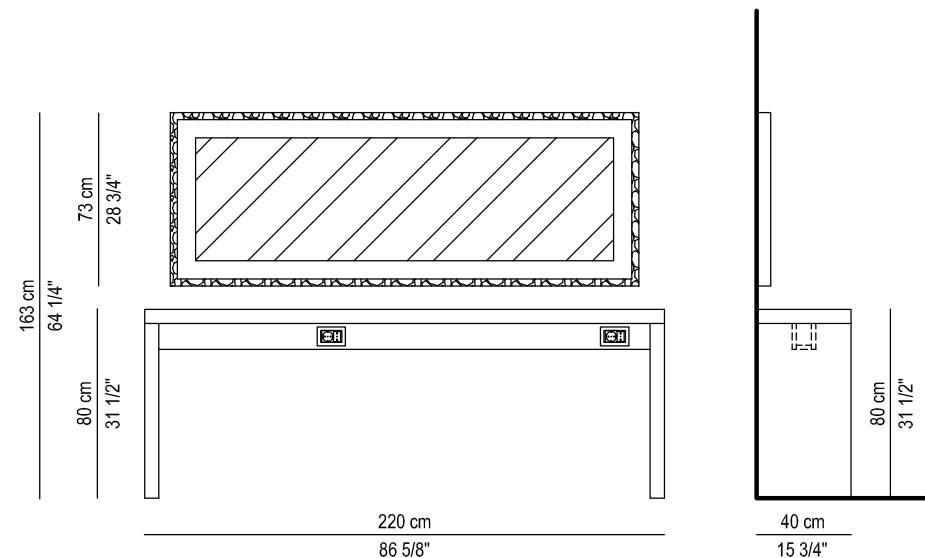

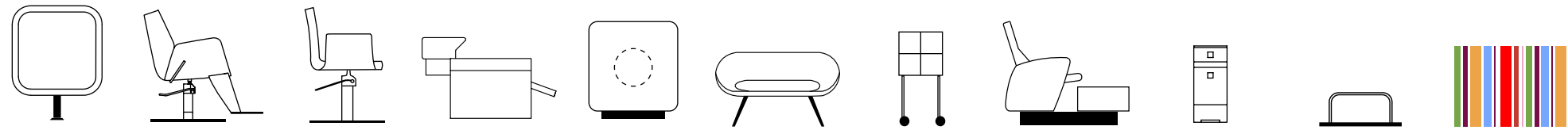

iPURE / IPURE WOOD

IPURE / IPURE WOOD

FF 5400 P2 / FF 5450 P2

€ 4.200,00

- Coiffeuse centrale 2 places avec cadre blanc laqué ou stratifié Orme-Cannelle T11. 4 Prises électriques intégrées. Sans repose-pieds.
- Posto lavoro centrale (2 posti) con cornice laccata bianco lucido o Orme-Cannelle T11 completo di 4 prese elettriche. Senza poggiatesta.
- Island 2 positions styling unit with a white lacquered or Orme-Cannelle T11 Frame. 4 integrated sockets. Footrests not included.
- Tocador central 2 puestos con contorno blanco lacado o Orme-Cannelle T11. 4 Enchufes incluidos. Reposapiés no incluido.
- Zentraler Frisiertisch 2 Plätze. Weißlackierter oder Orme-Cannelle T11 Rahmen mit 4 integrierten Steckdosen. Ohne Fußstütze.



BLANC LAQUE



ORME CANNELLE

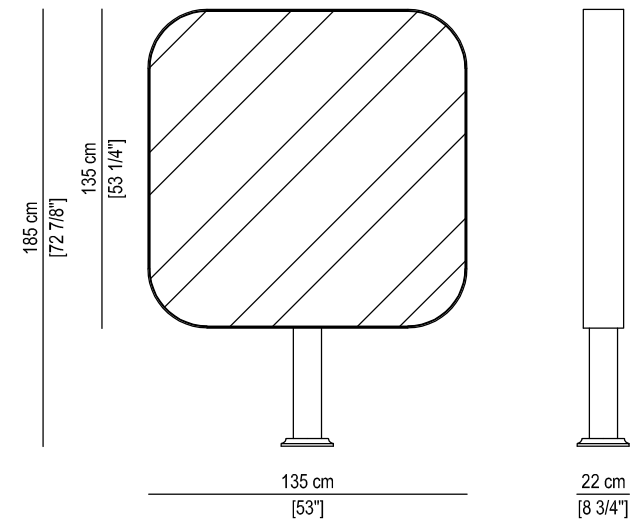

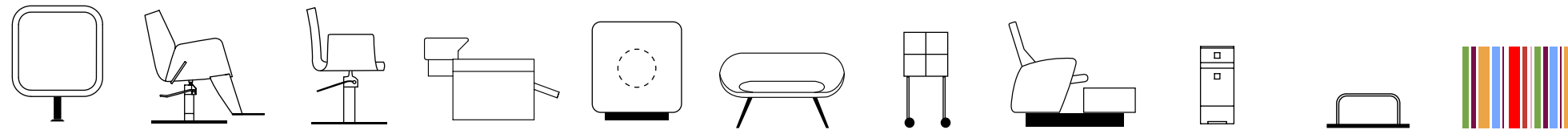

IPURE CADRE NOIR

IPURE CADRE NOIR / WOOD

€ 4.830,00

FF 5460 P2 CADRE / FF5450 P2 CADRE

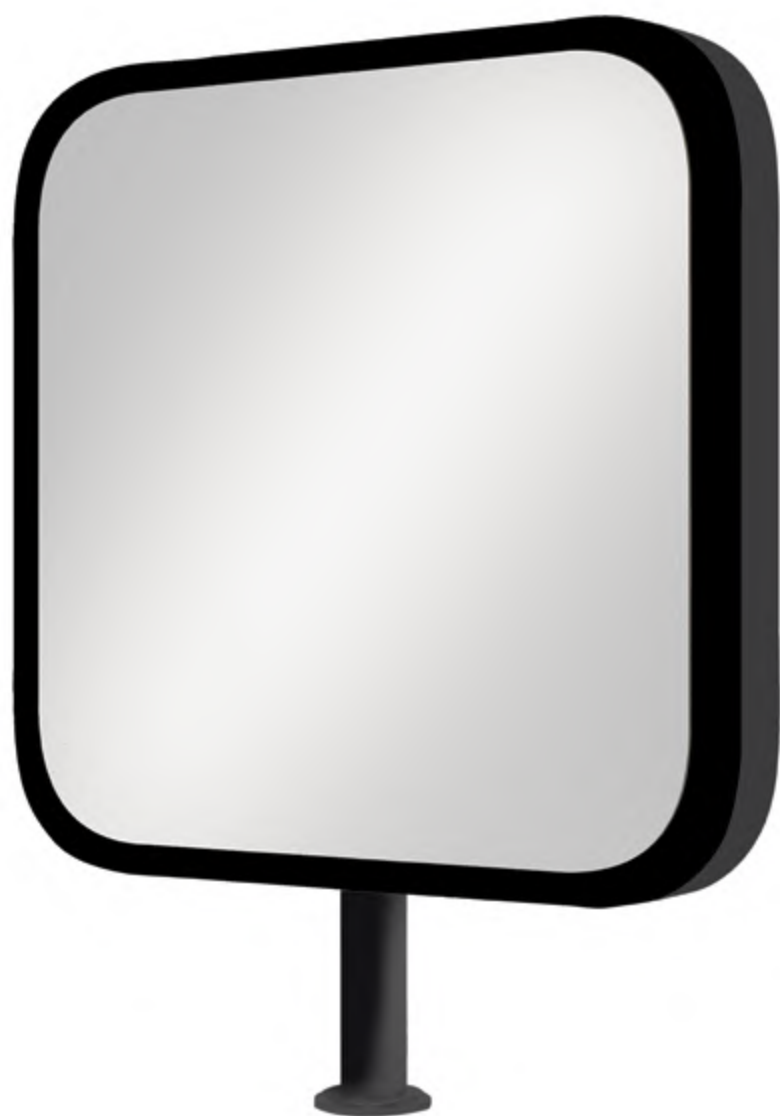

- Coiffeuse centrale 2 places avec cadre noir laqué ou stratifié Orme Cannelle T11. 4 Prises électriques intégrées. Sans illumination et sans repose-pieds.
- Posto lavoro centrale (2 posti) con cornice laccata nero lucido o versione laminato effetto legno Olmo Cannella completo di 4 prese elettriche. Senza illuminazione e poggiatesta.
- Island 2 position styling unit with a black lacquered or cinnamon elm (Orme-Cannelle T11) laminate frame, 4 integrated sockets. Without lighting or footrests.
- Tocador central 2 puestos con marco negro lacado o estratificado Orme-Cannelle T11. Con 4 enchufes. Sin retroiluminación y reposapiés.
- Zentraler Frisiertisch 2 Plätze. Weißlackierter oder Orme-Cannelle T11 Laminat Rahmen. Mit 4 integrierten Steckdosen ohne Beleuchtung und Fußstütze.

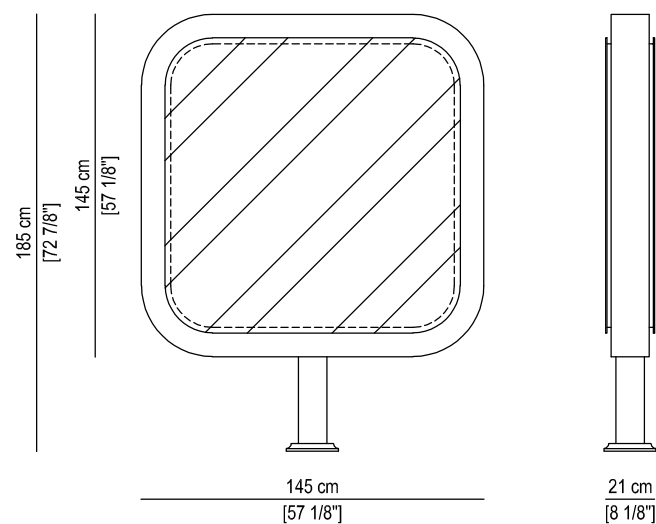

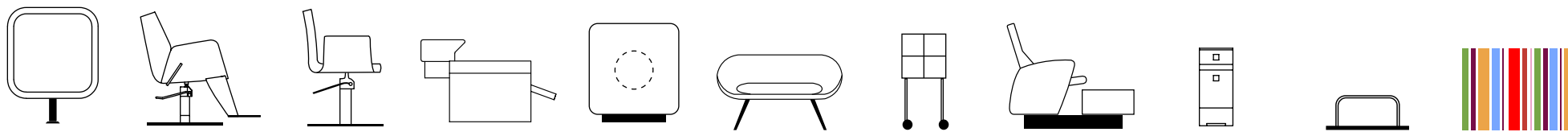

iPURE LED



IPURE LED / **IPURE WOOD LED**
 FF 5400 P2 LED / FF 5450 P2 LED

€ 5.460,00

- Coiffeuse centrale 2 places avec cadre blanc laqué ou stratifié Orme Cannelle T11. 4 Prises électriques intégrées et rétroéclairage LED. Sans repose-pieds.
- Posto lavoro centrale (2 posti) con cornice laccata bianco lucido o versione laminato effetto legno Olmo Cannella completo di 4 prese elettriche e illuminazione al LED. Senza poggiapiedi.
- Island 2 positions styling unit with a white lacquered or Orme-Cannelle T11 laminate Frame 4 integrated sockets and LED lighting. Footrests not included.
- Tocador central 2 puestos con marco blanco lacado o estratificado Orme-Cannelle T11. Con 4 enchufes y retroiluminación LED. Reposapiés no incluido.
- Zentraler Frisiertisch 2 Plätze. Weißlackierter oder Orme-Cannelle T11 Laminat Rahmen. Mit 4 integrierten Steckdosen und LED Beleuchtung. Ohne Fußstütze.

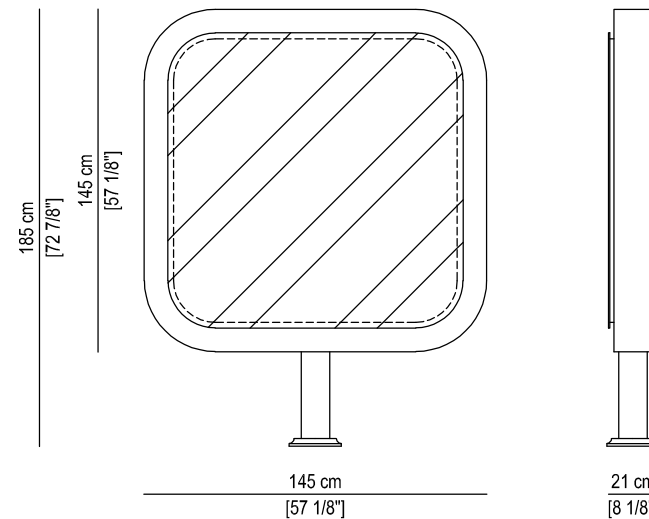

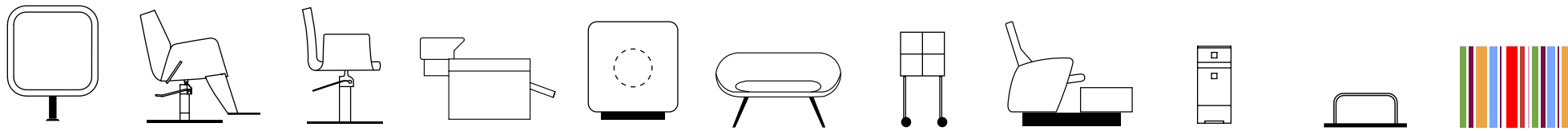

MAGNUM

MAGNUM NOIR

FF 5500

€ 3.675,00

- Coiffeuse centrale 2 places avec contour et tablette en métal noir mat, équipée de 4 prises électriques. Sans repose-pieds.
- Posto di lavoro centrale doppio con ripiano in metallo opaco nero, completo di 4 prese elettriche. Senza poggiapiedi.
- Island 2 positions styling unit with edge and shelf in matte black. 4 Integrated sockets. Footrests not included.
- Tocador central doble con cantos y repisa de metal negro mate, con 4 enchufes. Sin reposapiés.
- Zentraler Frisiertisch 2 Plätze mit Außenkontur und Ablage aus schwarzem mattem Metal. Mit 4 Steckdosen. Ohne Fußstütze.

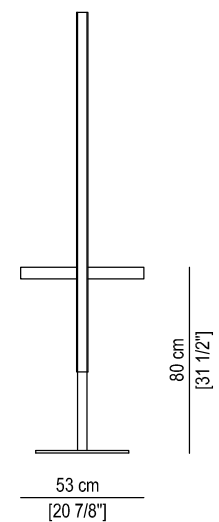
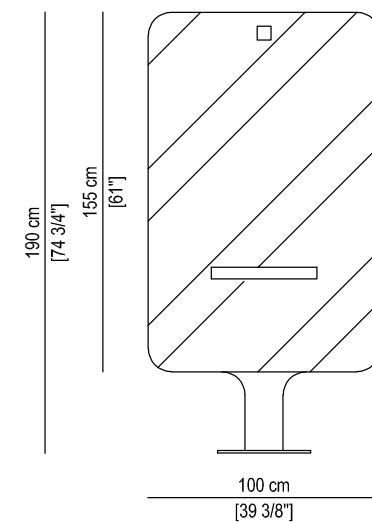

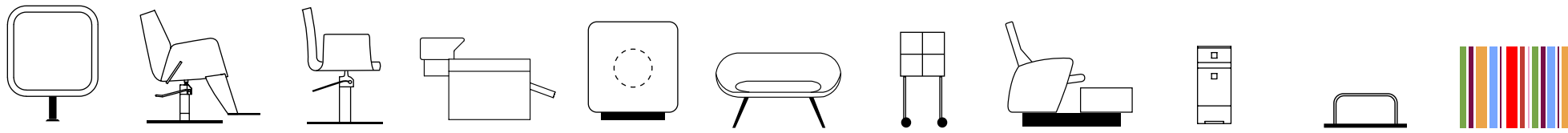

ORIGAMI BLANC

ORIGAMI BLANC 1P

FF 42001.B

€ 1.880,00

- Coiffeuse avec tablette en inox. Cadre en menuiserie avec finition en aluminium extrudé blanc brillant. Sans repose-pieds.
- Posto di lavoro con piano in acciaio inox. Cornice sagomata in alluminio finitura laccato bianco lucido. Senza poggiapiedi.
- Styling unit with stainless steel shelf. Frame in gloss white aluminium. Footrests not included
- Tocador con repisa inox. Marco de carpintería con acabado de aluminio extruido blanco brillante. Reposapiés no incluido.
- Frisierplatz mit Ablage aus Edelstahl. Rahmen aus Aluminium mit strahlend weiss Beschichtung. Ohne Fußstütze.

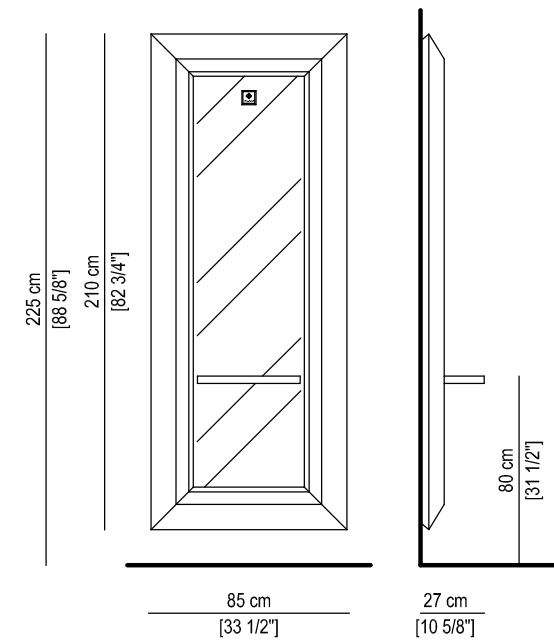

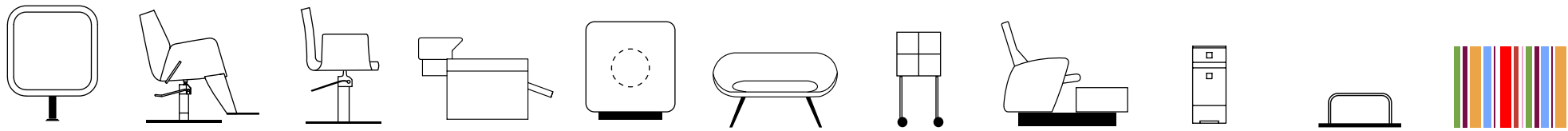

ORIGAMI COLOR

ORIGAMI COLOR 1P

FF 42001.N

€ 2.436,00

- Coiffeuse avec tablette en inox. Cadre en menuiserie avec finition en aluminium extrudé. Coloris au choix (nous fournir le RAL). Sans repose-pieds.
- Posto di lavoro con piano in acciaio inox. Cornice sagomata in estruso di alluminio verniciatura colori RAL a scelta. Senza poggiapiedi.
- Styling unit with stainless steel shelf. Aluminium frame in the RAL color of your choice. Footrest not included.
- Tocador con repisa inox. Marco de carpintería con acabado de aluminio extruido. Color para elegir (facilitarnos el RAL). Reposapiés no incluido.
- Frisierplatz mit Ablage aus Edelstahl. Rahmen mit Aluminium Beschichtung. Farbe aus Ihrem Wahl (RAL mitgeben). Ohne Fußstütze.

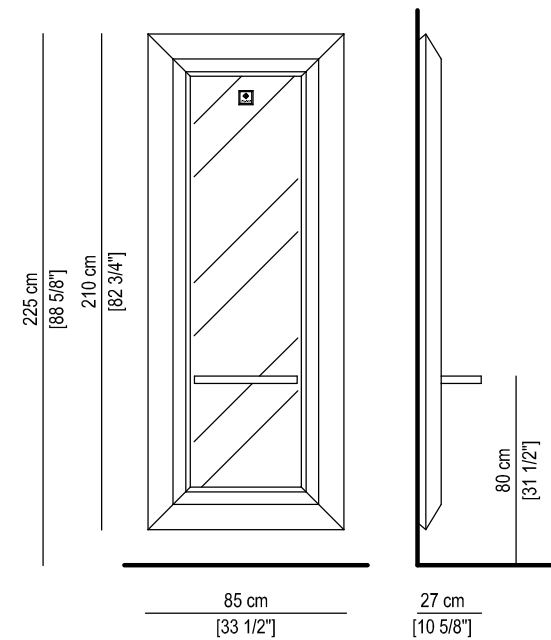

ORIGAMI BLANC 2P

ORIGAMI BLANC 2P

FF 42002.B

€ 4.305,00

- Coiffeuse murale 2 places avec tablette en inox. Cadre en menuiserie avec finition en aluminium extrudé blanc brillant. Sans repose-pieds.
- Posto di lavoro con piano in acciaio inox. Cornice sagomata in alluminio finitura laccato bianco lucido. Senza poggiapiedi.
- Styling unit with stainless steel shelf. White frame in aluminium. Footrests not included.
- Tocador mural 2 puestos con repisa inox. Marco de carpintería con acabado de aluminio extruido blanco. Reposapiés no incluido.
- Frisierplatz mit Ablage aus Edelstahl. Rahmen aus Aluminium mit strahlend weiss Beschichtung. Ohne Fußstütze.

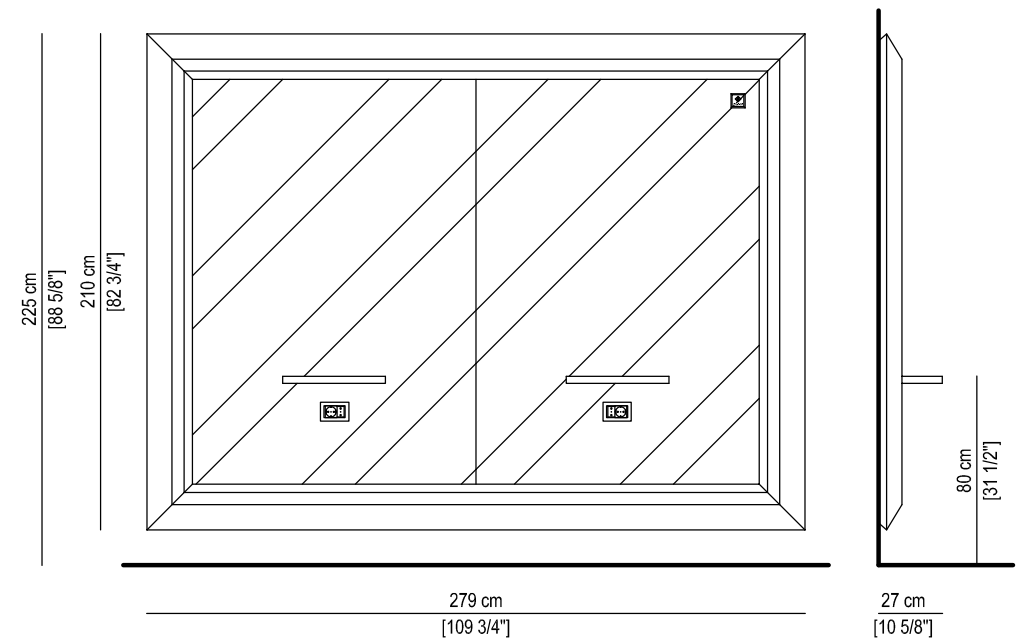

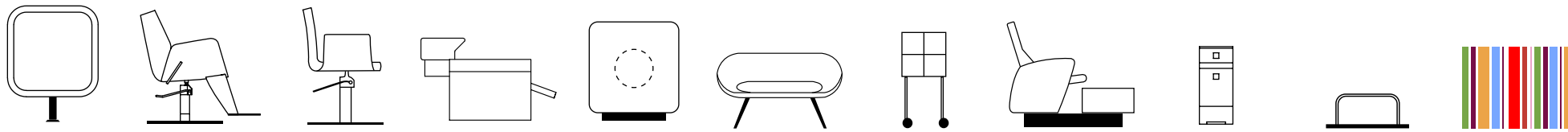

ORIGAMI COLOR 2P

ORIGAMI COLOR 2P

FF 42002.N

€ 4.694,00



- Coiffeuse murale 2 places avec tablette en inox. Cadre en menuiserie avec finition en aluminium extrudé. Coloris au choix (nous fournir le RAL). Sans repose-pieds.
- Posto di lavoro con piano in acciaio inox. Cornice sagomata in estruso di alluminio verniciatura colori RAL a scelta. Senza poggiapiedi.
- Styling unit with stainless steel shelf. Aluminium frame in the RAL color of your choice. Footrests not included.
- Tocador mural 2 puestos con repisa inox. Marco de carpintería con acabado de aluminio extruido. Color para elegir (facilitarnos el RAL). Reposapiés no incluido.
- Frisierplatz mit Ablage aus Edelstahl. Rahmen aus Aluminium. Farbe aus Ihrem Wahl (RAL mitgeben). Ohne Fußstütze.

colors
R A L



COLORIS AU CHOIX

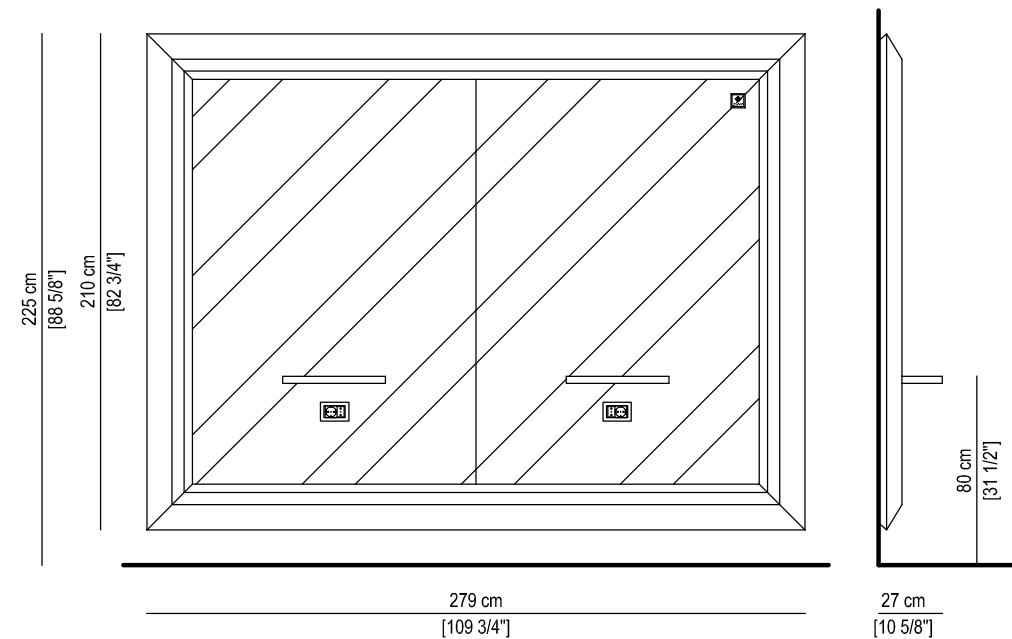

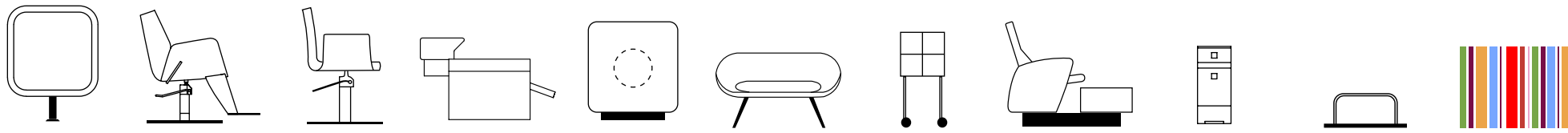

iTABLE

ITABLE

FF 1700

€ 1.565,00

- Coiffeuse murale avec tablette coloris blanc mat T41, pieds et chants coloris Orme - Cannelle T11. Chants du miroir coloris Orme - Cannelle T11. Sans repose-pieds.
- Posto di lavoro con piano bianco. Piedi e bordi in Orme - Cannelle. Senza poggiatesta.
- Styling unit wall position with matt white color shelf, edges Orme-Cannelle. Edge of the mirror Orme-Cannelle. Footrest not included.
- Tocador con repisa blanco mate T41, pies y cantos Orme - Cannelle T11. Contorno del espejo Orme - Cannelle T11. Sin reposapiés.
- Wand-Frisiertisch mit matter weißer Ablage, Seiten und Füße Orme-Cannelle T11. Seiten des Spiegels Orme-Cannelle T11. Ohne Fußstütze.

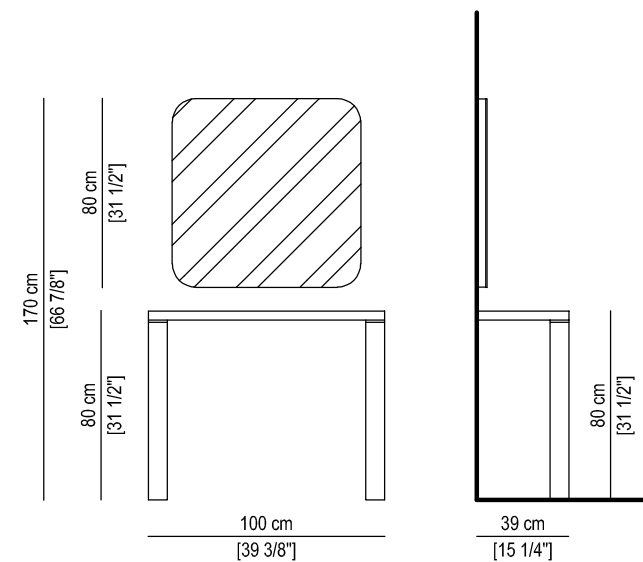

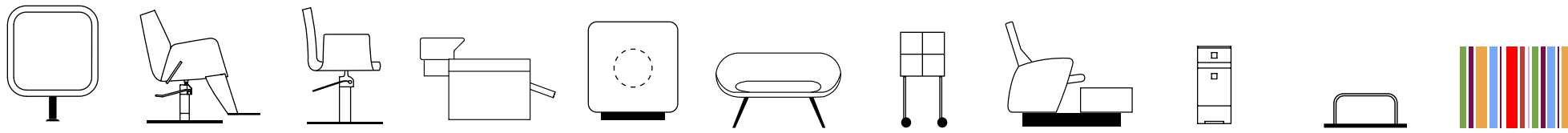

ITABLE MURALE 2P

ITABLE MURALE 2P

FF 1700 P2M

€ 2.667,00

- Coiffeuse murale 2 places. Stratifié Blanc T41 (mat) et chants Orme – Cannelle T11. 4 prises électriques intégrées. Sans repose-pieds.
- Posto di lavoro parete 2 posti. Struttura piano in nobilitato bianco opaco e bordi in finitura ORME CANNELLE. Completo di 4 prese elettriche. Senza poggiatesta
- Styling unit 2 places wall position. Laminate color White T41 and edges Orme-Cannelle T11. 4 integrated sockets. Footrests not included.
- Tocador 2 puestos. Estratificado Blanc T41 y cantos Orme-Cannelle T11. 4 tomas integradas. Sin reposapiés.
- Wand-Frisiertisch 2 Plätze. Weiße Laminatsfarbe T41 und Seiten Orme-Cannelle T11. 4 integrierten Steckdosen. Ohne Fußstütze.

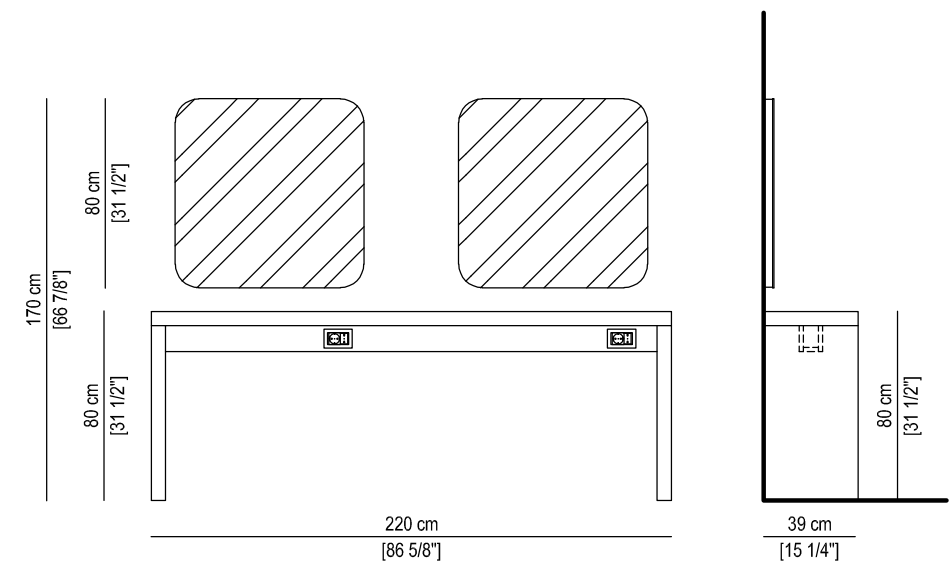

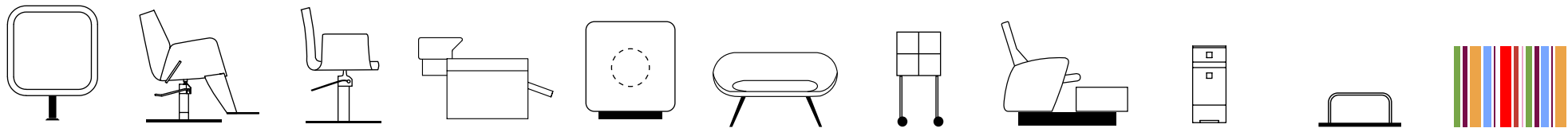

itable 4P CENTRALE

ITABLE 4P CENTRALE

€ 3.024,00

FF 1700 P4

- Coiffeuse centrale 4 places avec tablette coloris Blanc T41 mat, chants Orme - Cannelle T11. 8 Prises électriques intégrées. Sans repose-pieds.
- Posto lavoro centrale 4 posti con piano bianco e bordi Orme - Cannelle, con 8 prese elettriche. Senza poggiapiedi.
- Island 4 positions styling unit with a white shelf and edges Orme-Cannelle. 8 Sockets integrated. Footrests not included.
- Tocador central 4 puestos con marco blanco mate T41 y cantos Orme-Cannelle T11. 8 Enchufes incluidos. Sin reposapiés.
- Zentraler Frisiertisch 4 Plätze mit weißer Ablage und Seiten Orme-Cannelle T11. 8 Integrierten Steckdosen. Ohne Fußstütze.

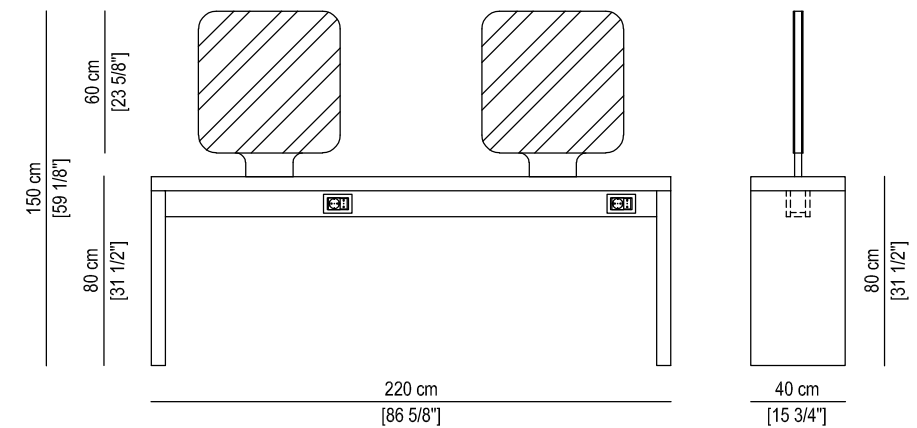

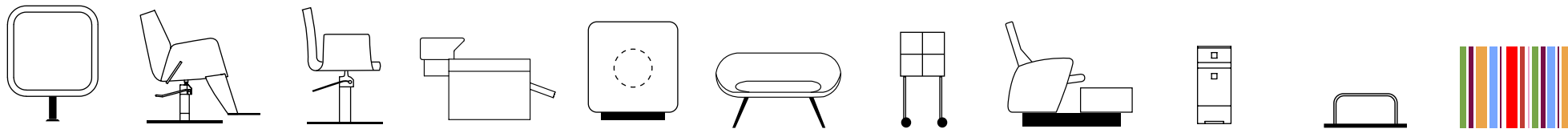

iTABLE 2P CENTRALE

ITABLE 2P CENTRALE

FF 1700 P2C

€ 2.205,00

- Coiffeuse centrale 2 places. Stratifié Blanc T41 (mat) et champs Orme – Cannelle T11. 4 prises électriques intégrées. Sans repose-pieds.
- Posto di lavoro centrale 2 posti. Struttura piano in nobilitato bianco opaco e bordi in finitura ORME CANNELLE. Completo di 4 prese elettriche. Senza poggiatesta.
- Island 2 positions styling unit. Laminate color White T41 and edges Orme-Cannelle T11. 4 integrated sockets. Footrests not included.
- Tocador central 2 puestos. Estratificado Blanc T41 y cantos Orme-Cannelle T11. 4 tomas integradas. Sin reposapiés.
- Zentraler Frisiertisch 2 Plätze. Weiße Laminatsfarbe T41 und Seiten Orme-Cannelle T11. 4 integrierten Steckdosen. Ohne Fußstütze.

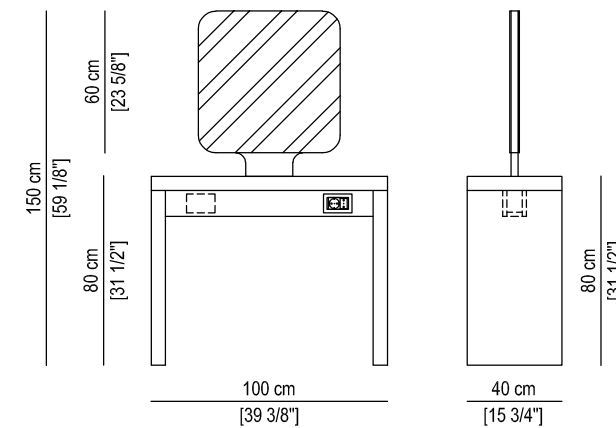

ITABLE 4PL CENTRALE

ITABLE 4PL CENTRALE NOIR

FF 1700P4NO

€ 3.024,00

- Coiffeuse centrale 4 places en stratifié Noir Luxe T15 avec 8 Prises électriques intégrées. Sans repose-pieds.
- Posto di lavoro 4 posti centrale in nobilitato colore T15 Noir Luxe completo di 8 prese elettriche senza appoggia piedi.
- 4 seater island styling unit in black gloss laminate (Noir Luxe T15) with 8 fitted sockets. Footrests not included.
- Tocador central de 4 plazas en melamina Negro Luxe T15 con 8 tomas eléctricas integradas. sin reposapiés T11. 8 Enchufes incluidos. Sin reposapiés.
- Zentraler Frisiertisch 4 Plätze in Black Luxe T15 Melamin mit 8 integrierten Steckdosen. Ohne Fußstütze

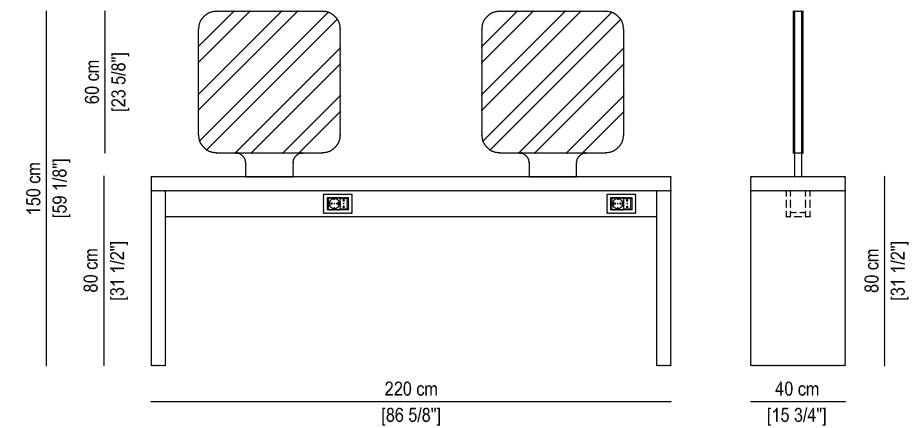

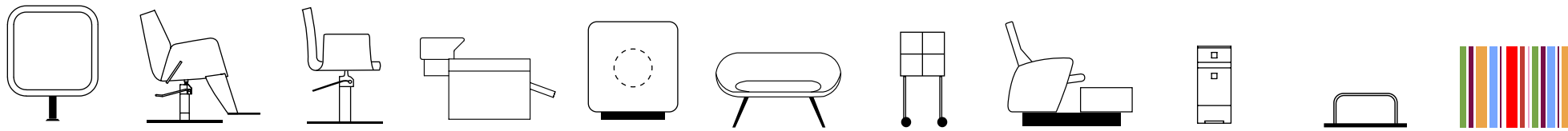

KRYSTAL CENTRALE 2P

KRYSTAL CENTRALE 2P

FF 7000 P2

€ 2.205,00

- Coiffeuse centrale 2 places. Stratifié au choix dans notre gamme. 2 porte-séchoirs. Panneaux de séparation en plexiglas opale. Sans repose-pieds.
- Posto di lavoro 2 posti. Disponibile in tutte le versioni della nostra gamma. Con 2 portaphon. Senza poggiapiedi.
- Island 2 positions styling unit available in all laminate colors from our range. With 2 hair dryer holders in polished aluminium and white plexiglas central panel. Footrests not included.
- Tocador central 2 puestos. Estratificado a escoger en nuestra gama. 2 portasecadores. Separador de metacrilato. Sin reposapiés.
- Zentraler Frisiertisch 2 Plätze. Alle Laminatsfarben unserer Musterpalette. Mit 2 Fönhaltern aus poliertem Aluminium. Zwischenplatte aus weißem Plexiglas. Ohne Fußstütze.

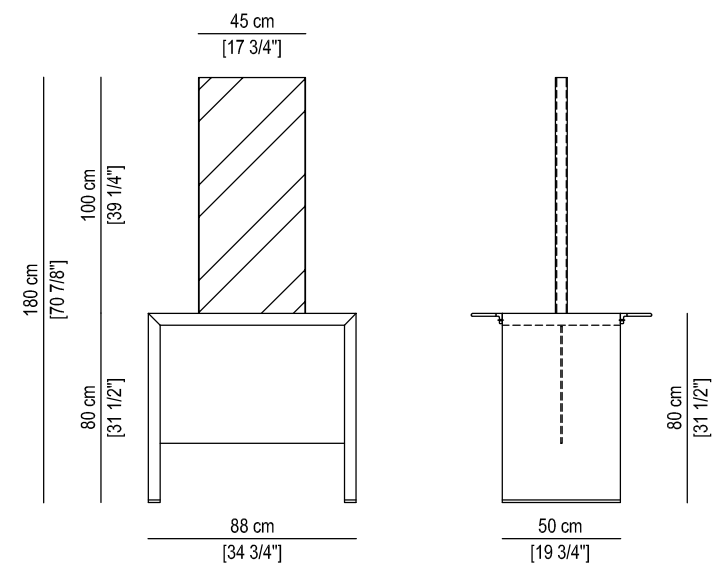



KRYSTAL CENTRALE 4P

KRYSTAL CENTRALE 4P

€ 3.486,00

FF 7000 P4

- Coiffeuse centrale 4 places. Stratifié au choix dans notre gamme. Colonne acier Inox, panneaux de séparation en plexiglas opale. 4 porte-séchoirs et 4 prises. Sans repose-pieds.
- Posto di lavoro 4 posti. Disponibile in tutte le versioni della nostra gamma. Con 4 portaphon e 4 prese. Senza poggiapiedi.
- Island 4 positions styling unit available in all laminate colors from our range. Columns in stainless steel with 4 integrated sockets and 4 hair dryer holders in polished aluminium. With white plexiglas central panel. Footrests not included.
- Tocador central 4 puestos. Estratificado a escoger en nuestra gama. Columna de acero inoxidable con 4 enchufes, separador de metacrilato, 4 porta-secadores. Sin reposapiés.
- Zentraler Frisiertisch 4 Plätze. Alle Laminatsfarben unserer Musterpalette. Säulen aus Edelstahl mit 4 integrierten Steckdosen. Mit 4 Fönhaltern aus poliertem Aluminium. Zwischenplatte aus weißem Plexiglas. Ohne Fußstütze.

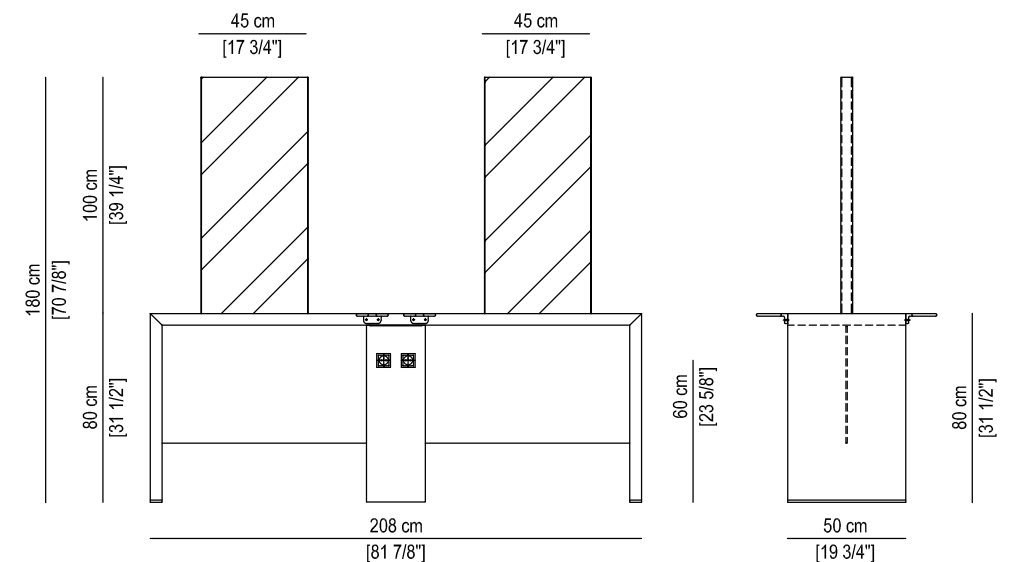



KRYSTAL MURALE 1P

KRYSTAL MURALE 1P

FF 7100 P1

€ 1.974,00

- Coiffeuse murale 1 place. Stratifié au choix dans notre gamme. 1 porte-séchoir. Sans repose-pieds.
- Posto di lavoro. Disponibile in tutte le versioni della nostra gamma. Con portaphon. Senza pannello plexi. Senza poggiapiedi.
- Styling unit single wall position. In all laminate colors from our range. With 1 hair dryer holder in polished aluminium. Footrest not included.
- Tocador mural 1 puesto. Estratificado a escoger en nuestra gama. 1 porta-secador. Sin reposapiés.
- Wand-Frisiertisch 1 Platz. Alle Laminatsfarben unserer Musterpalette. Mit 1 Fönhalter aus poliertem Aluminium. Ohne Fußstütze.

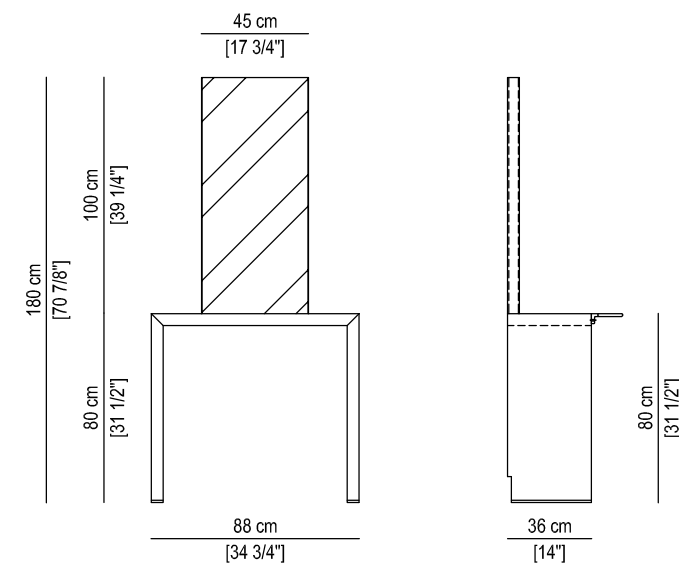

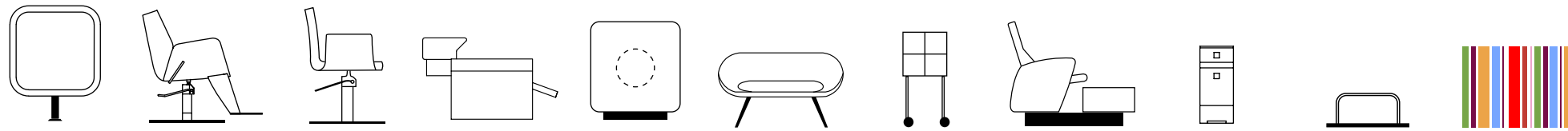

KRYSTAL MURALE 2P

KRYSTAL MURALE 2P

€ 2.888,00

FF 7100 P2

- Coiffeuse murale 2 places. Stratifié au choix dans notre gamme. Colonne acier Inox, 2 porte-séchoirs et 2 prises. Sans repose-pieds.
- Posto di lavoro murale 2 posti. Disponibile in tutte le versioni della nostra gamma. Con 2 portaphon e 2 prese. Senza pannello plexi. Senza poggiapiedi.
- Styling unit 2 places wall position. In all laminate colors from our range. Column in stainless steel with 2 integrated sockets and 2 hair dryer holders in polished aluminium. (UK sockets available upon request). Footrests not included.
- Tocador mural 2 puestos. Estratificado a escoger en nuestra gama. Columna de acero inoxidable con 2 enchufes y 2 porta-secadores. Sin reposapiés.
- Wand-Frisiertisch 2 Plätze. Alle Laminatsfarben unserer Musterpalette. Säule aus Edelstahl mit 2 integrierten Steckdosen. Mit 2 Fönhaltern aus poliertem Aluminium. Ohne Fußstütze.

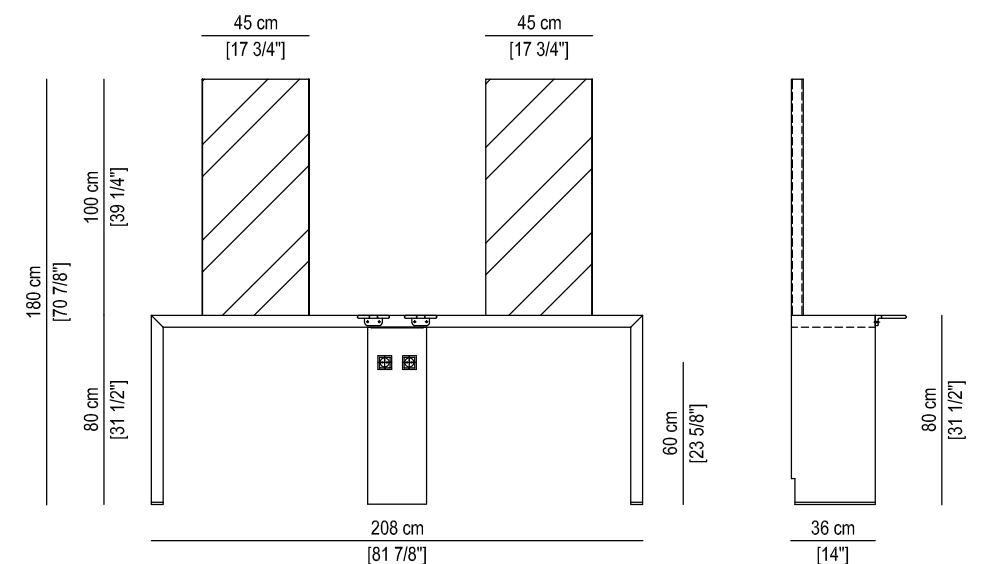



KRYSTAL MURALE 3P

KRYSTAL MURALE 3P

€ 3.788,00

FF 7100 P3



- Coiffeuse murale 3 places. Stratifié au choix dans notre gamme. Colonnes acier Inox, 4 porte-séchoirs et 4 prises. Sans repose-pieds.
- Posto di lavoro murale 3 posti. Disponibile in tutte le versioni della nostra gamma. Con 4 portaphon e 4 prese. Senza pannello plexi. Senza poggiaiedi.
- Styling unit 3 places wall position. In all laminate colors from our range. Columns in stainless steel with 4 integrated sockets and 4 hair dryer holders in polished aluminium. (UK sockets available upon request). Footrests not included.
- Tocador mural 3 puestos. Estratificado a escoger en nuestra gama. Columnas de acero inoxidable con 4 enchufes y 4 porta-secadores. Sin reposapiés.
- Wand-Frisiertisch 3 Plätze. Alle Laminatsfarben unserer Musterpalette. Säulen aus Edelstahl mit 4 integrierten Steckdosen. Mit 4 Fönhaltern aus poliertem Aluminium. Ohne Fußstütze.

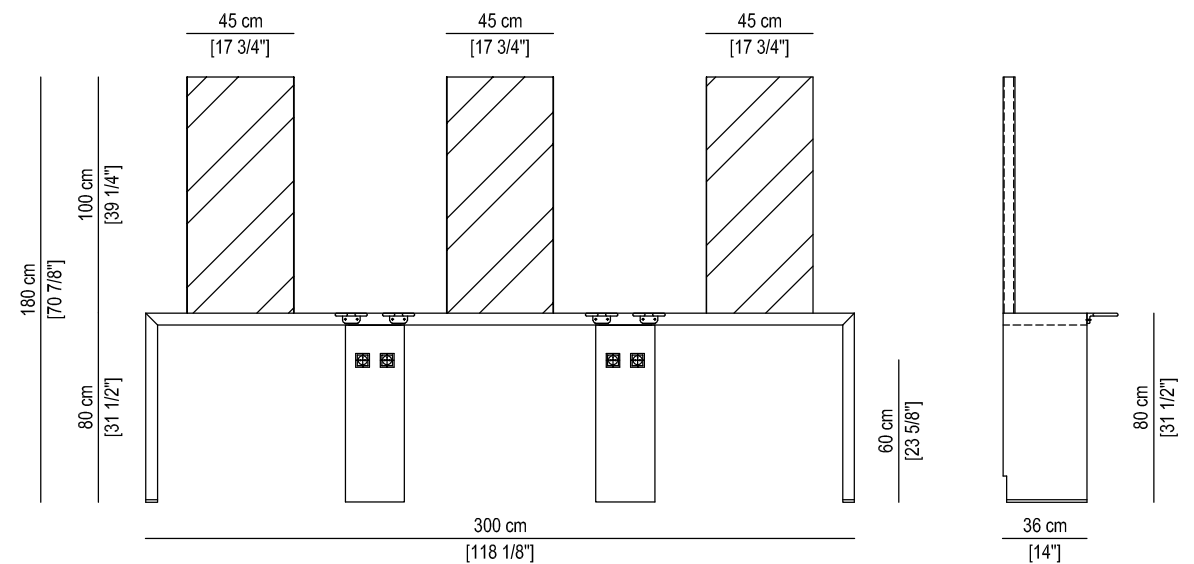

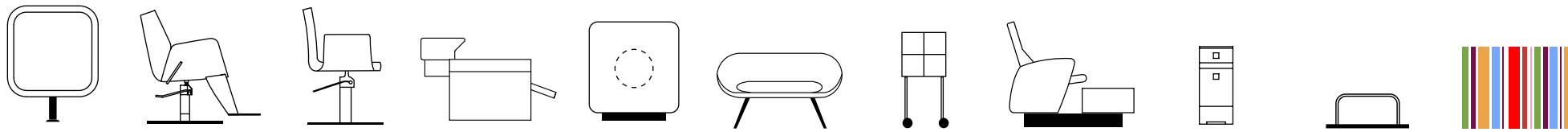

PERFORM ELITE

PERFORM ELITE

FF 3910

€ 1.071,00

- Coiffeuse avec tablette en aluminium poli. Repose-pieds en inox intégré. Partie inférieure en stratifié Noir Luxe T15 ou Blanc Luxe T31.
- Posto di lavoro con ripiano in alluminio lucidato. Poggiapiedi cromato lucido. Parte inferiore in laminato Noir Luxe T15 o Blanc Luxe T31.
- Styling unit with polished aluminium shelf. Integrated footrest in stainless steel. Lower part in laminate Noir Luxe T15 or Blanc Luxe T31.
- Tocador con repisa de aluminio pulido. Reposapiés de acero inoxidable integrado. Parte inferior en Noir Luxe T15 o Blanc Luxe T31.
- Frisierplatz mit Ablage aus poliertem Aluminium. Integrierte Fußstütze aus Edelstahl. Unterteil aus Laminat Noir Luxe T15 oder Blanc Luxe T31.

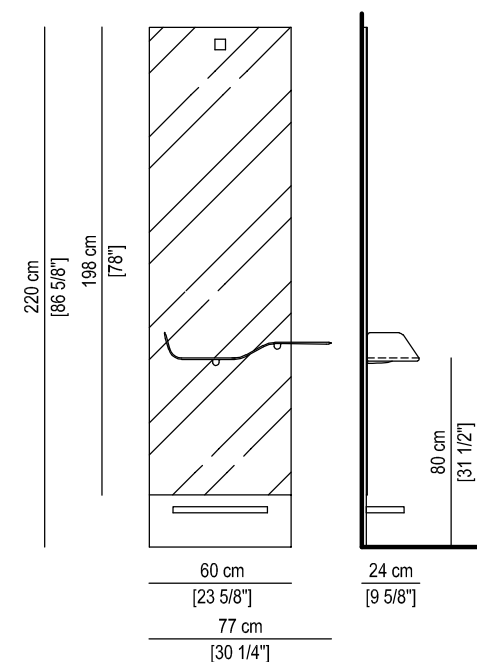



PERFORM ELITE PLUS

SUPPLÉMENT PERFORM PLUS

€ 410,00

SPLUS 39

- Supplément pour 6 étagères de rangement à l'arrière (3 de chaque côté) et une prise électrique.
- Supplemento per 6 ripiani nel retro e una presa elettrica.
- Supplement for 6 integrated shelves and electrical socket.
- Cargo adicional por 6 estantes traseros (3 de cada lado) y un enchufe.
- Aufpreis für 6 hintere Regale und eine Steckdose.

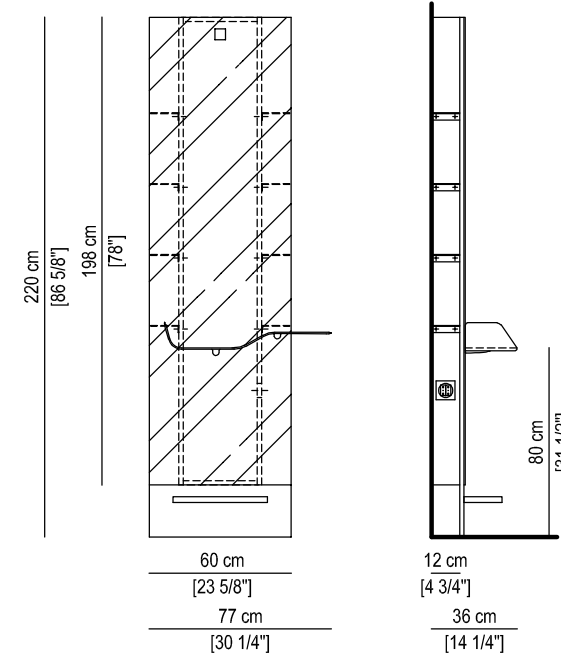

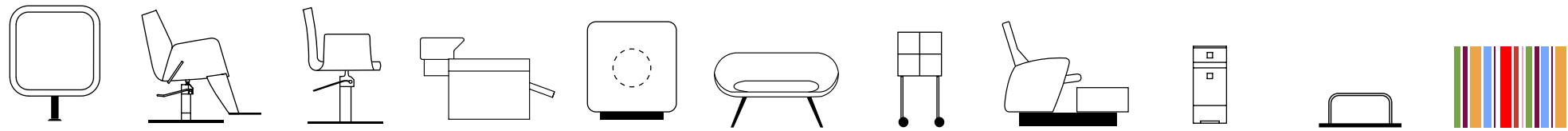

SUPPLEMENT PERFORM LED



SUPPLÉMENT PERFORM LED

SLED 39

€ 609,00

- Supplément pour éclairage LED.
- Supplemento per illuminazione LED.
- Upcharge for LED lighting.
- Cargo adicional por iluminación LED.
- Aufpreis für LED Beleuchtung.

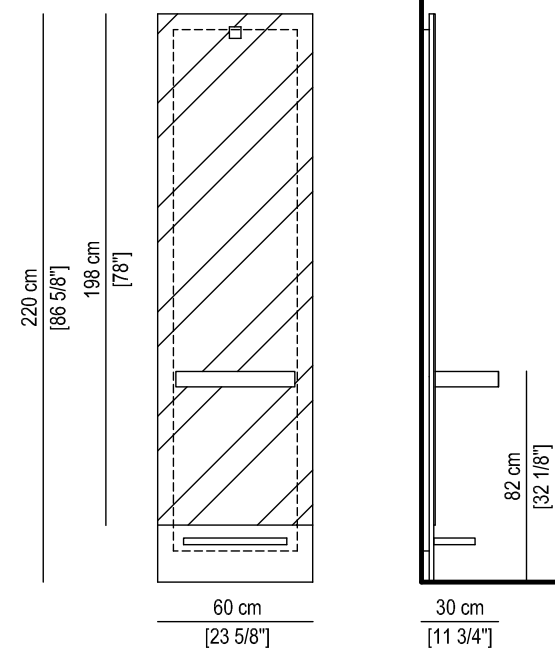

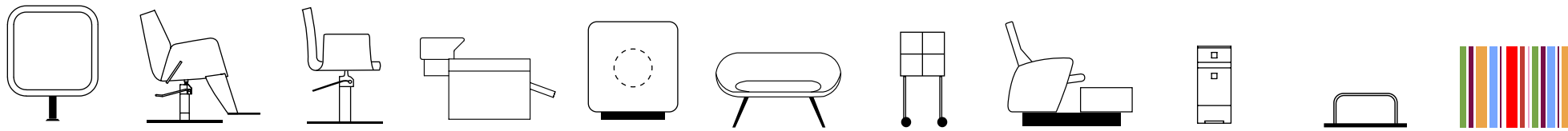

PERFORM ALLUSION

PERFORM ALLUSION

€ 1.124,00

FF 3900

- Coiffeuse avec tablette en inox. Repose-pieds en inox intégré. Partie inférieure en stratifié Noir Luxe T15 ou Blanc Luxe T31.
- Posti lavoro con ripiano in acciaio inox. Poggiapiedi cromato lucido. Parte inferiore in laminato Noir Luxe T15 o Blanc Luxe T31.
- Styling unit with stainless steel shelf. Integrated footrest in stainless steel. Lower part in laminate Noir Luxe T15 or Blanc Luxe T31.
- Tocador con repisa de acero inoxidable. Reposapiés de acero inoxidable integrado. Parte inferior en Noir Luxe T15 o Blanc Luxe T31.
- Frisierplatz mit Ablage aus Edelstahl. Integrierte Fußstütze aus Edelstahl. Unterteil aus Laminat Noir Luxe T15 oder Blanc Luxe T31.

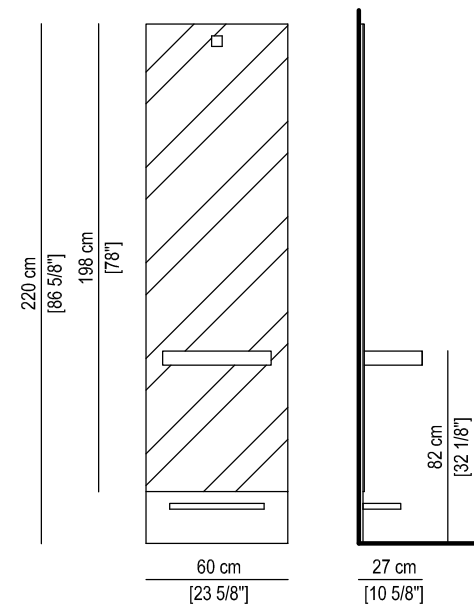



PERFORM ALLUSION CUT

PERFORM ALLUSION CUT

€ 1.040,00

FF 3960

- Coiffeuse avec tablette inox. Repose-pieds en inox intégré. Partie inférieure en stratifié noir luxe T15 ou blanc luxe T31. Miroir plus court.
- Posto lavoro con ripiano in acciaio inox. Poggiapiedi cromato lucido. Parte inferiore in laminato Noir T15 o Bianco Luxe T31. Specchio corto.
- Styling unit with stainless steel shelf and integrated footrest in stainless steel. Laminate in black Noir Luxe T15 or white Blanc Luxe T31. Half length mirror.
- Tocador con repisa de acero inox. Reposapiés de acero inox. Parte inferior de estratificado color negro NOIR LUXE TT15 o blanco BLANC LUXE T31. Espejo más corto.
- Frisierplatz mit Ablage aus poliertem Aluminium. Integrierte Fußstütze aus Edelstahl. Unterteil aus Laminat Noir Luxe T15 oder Blanc Luxe T31. Kleiner Spiegel.

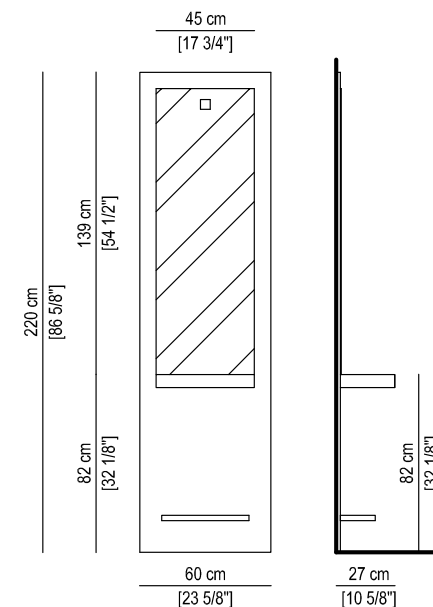



SPEKY

SPEKY

FF 3600

€ 734,00

- Coiffeuse avec tablette Inox. Sans repose-pieds.
- Posto di lavoro a parete con ripiano in acciaio inox. Senza poggiapiedi.
- Styling unit with stainless steel shelf. Footrest not included.
- Tocador con repisa de acero inoxidable. Sin reposapiés.
- Frisierplatz mit Ablage aus Edelstahl. Ohne Fußstütze.

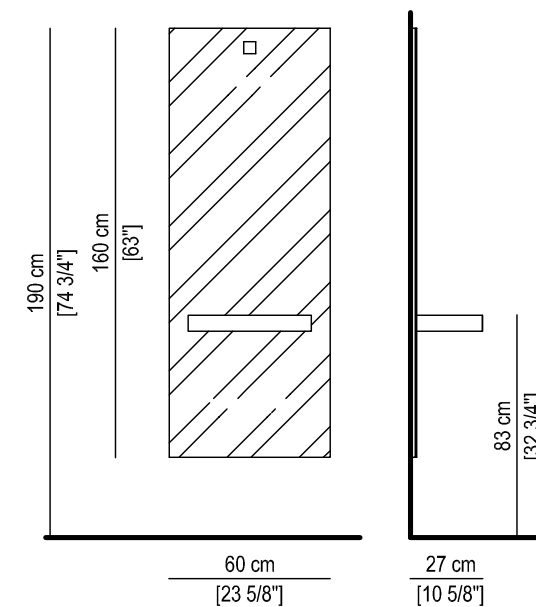

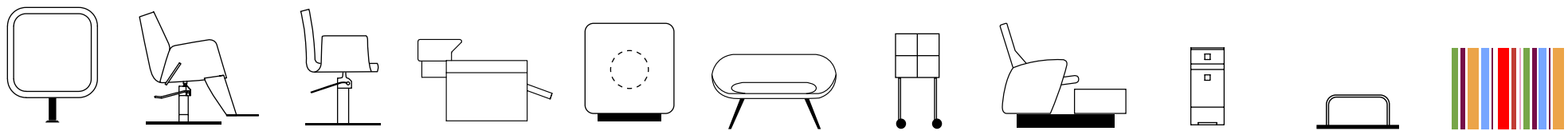

SPEKY DOUBLE

SPEKY DOUBLE

FF 3620

€ 2.310,00

- Coiffeuse centrale 2 places avec tablette Inox. 3+3 étagères de rangement de chaque côté, 2 prises et 2 support-séchoirs. Sans repose-pieds.
- Posto lavoro doppio con ripiano in acciaio inox. 3+3 ripiani portaprodotti, 2 portaphon e 2 prese. Senza poggiapiedi.
- Double styling unit with stainless steel shelf. With 3+3 back shelves for storage. 2 sockets and 2 hairdryer holders (UK socket available upon request). Footrests not included.
- Tocador central 2 puestos con repisa de acero inoxidable. 3+3 estantes traseros de cada lado, 2 porta secadores y 2 enchufes. Sin reposapiés.
- Doppelfrisierplatz mit Ablage aus Edelstahl. Mit 3+3 Regalen an der Seite, 2 Steckdosen und 2 Fönhaltern. Ohne Fußstütze.

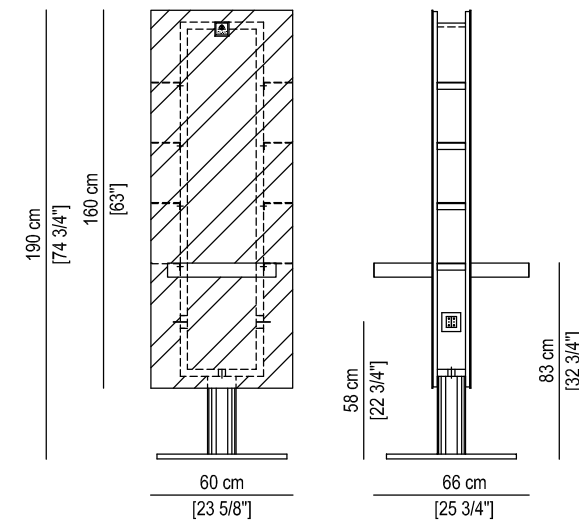

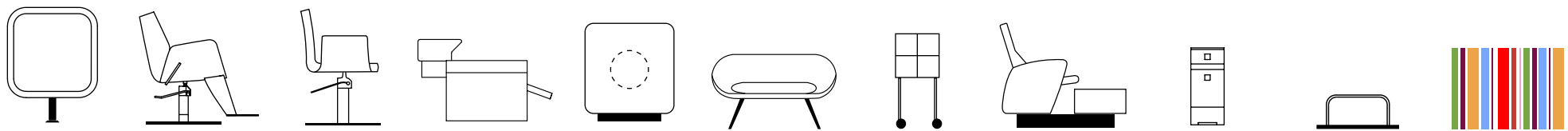

KRYS BAR

KRYS BAR FF 7200

€ 4.547,00

- Bar à couleurs en stratifié Noir Luxe T15 avec deux miroirs rabattables et repose-pied en inox.
- Postazione consulenza in acrilico nero lucido con 2 specchi ribaltabili e poggiatesta in metallo cromato lucido.
- Color bar in laminate Noir Luxe T15 with 2 folding mirrors and stainless steel footrest.
- Bar para coloración estratificado Noir Luxe T15. Con 2 espejos abatibles y apoyapies inox.
- Beratungstisch in Laminat Noir Luxe T15 mit 2 klappbaren Spiegeln. Inkl Fußstützen.

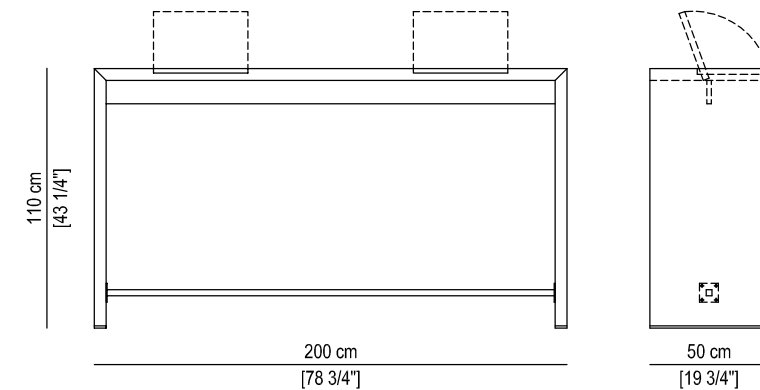

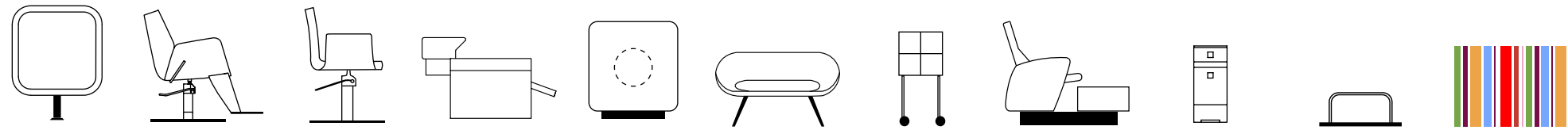

ROLLER II

ROLLER II FF ROLLER

€ 1.187,00

- Coiffeuse école double avec 2 porte étaux, 2 prises électriques et roulettes blocables. Tablettes stratifiées au choix dans notre gamme.
- Posto lavoro doppio per scuole con 2 porta testine, 2 prese elettriche e rotelle con blocco. Pianetti in laminato. Disponibile in tutte le versioni della nostra gamma.
- 2 places island styling unit for schools. With 2 wig head clamps, 2 sockets, rubber castors with brake.(UK socket available upon request) Laminate shelves in all colors from our range.
- Tocador doble para escuelas con 2 porta tornos, 2 enchufes y ruedas bloqueables. Repisas estratificadas. Color a escoger en nuestra gama.
- Doppelfrisierplatz für Schule. Inkl. 2 Klemmhalter und 2 Steckdosen, Gummirollen mit Bremsen. Ablage aus Laminat unserer Musterpalette

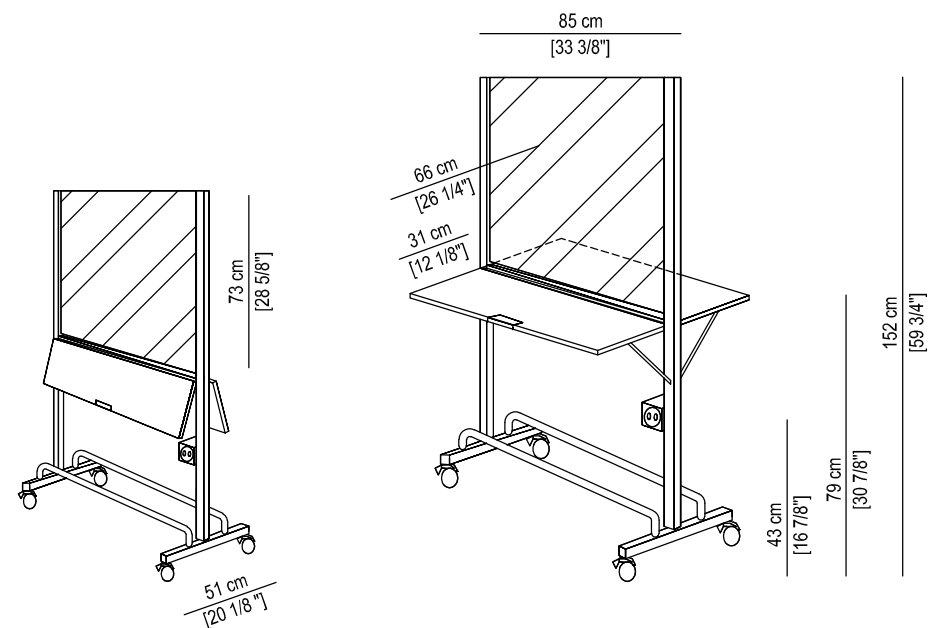

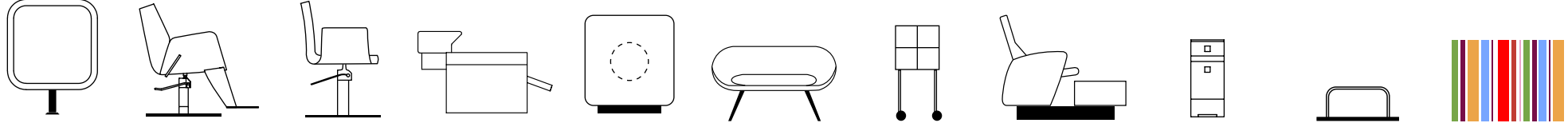

02

H O M M E

U O M O

M A N

H O M B R E

M A N N

< > >

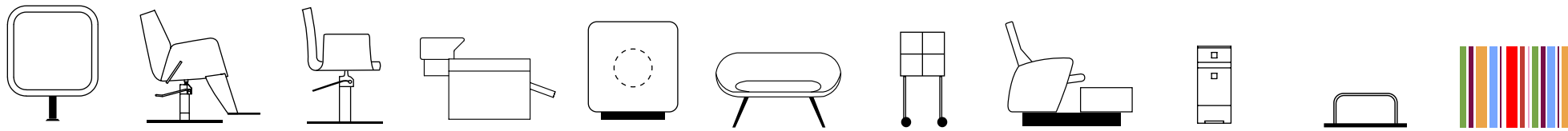

MENSPACE

AVEC CUVETTE

MENSPACE AVEC CUVETTE

FF 7510

€ 3.255,00

- Coiffeuse homme avec plan de travail hydrofuge Noir (fullcolor uniquement), miroir décoré, cuvette céramique, meuble avec tiroirs. 2 Prises électriques comprises. Uniquement en stratifié Orme Cannelle T11.
- Postazione da lavoro per uomo completa di specchio decorato, lavabo in ceramica personalizzato e mobiletti con cassetti. 2 Prese elettriche comprese. Solamente in Orme Cannelle.
- Styling unit for men, decorated mirror, integrated bowl and cabinet with drawers. 2 Integrated plugs. Orme Cannelle only.
- Tocador para hombre, espejo decorado, cubeta de cerámica integrada y mueble con cajones. 2 enchufes eléctricos incluidos. Orme Cannelle T11 solamente.
- Barbierplatz mit Keramikbecken. Dekorierter Spiegel. Möbel mit Schubladen mit 2 integrierten Steckdosen. Nur Orme Cannelle.

CUVETTE NOIRE

€ 116,00

- Cuvette noire, vasca nera, black basin, lavabo negro, schwarzes Becken

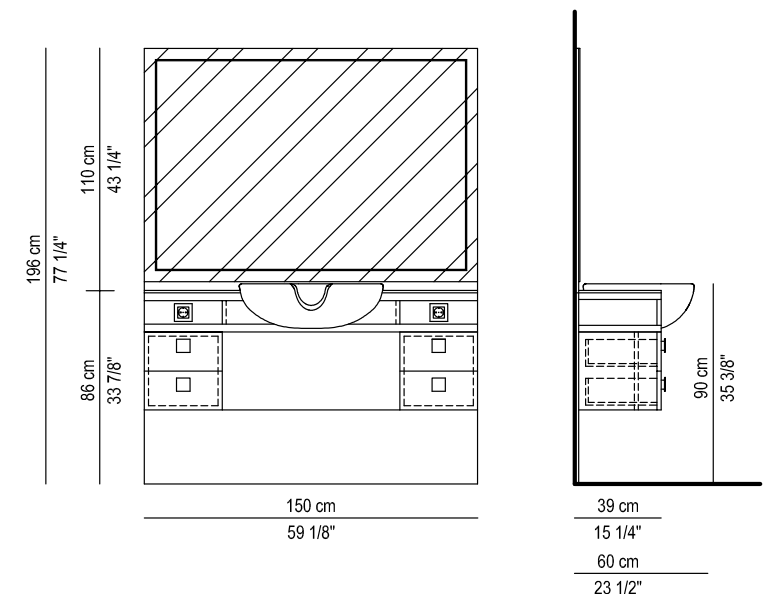

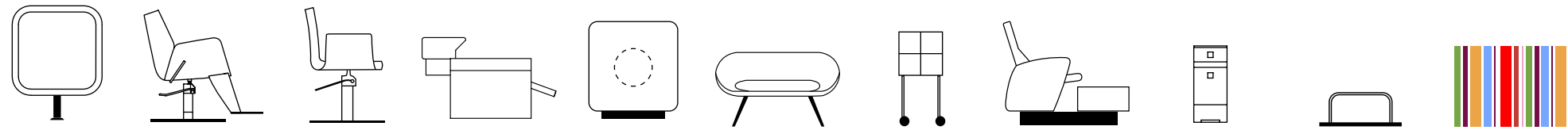

MENSPACE

SANS CUVETTE

MENSPACE SANS CUVETTE

FF 7500

€ 2.310,00

- Coiffeuse homme, miroir décoré et meuble avec tiroirs. 2 prises électriques comprises. Uniquement en stratifié Orme Cannelle T11.
- Postazione da lavoro per uomo completa di specchio decorato e mobiletti con cassetti. 2 Prese elettriche comprese. Solamente in Orme Cannelle.
- Styling unit for men, decorated mirror and cabinet with drawers. 2 Integrated plugs. Orme Cannelle only.
- Tocador para hombre, espejo decorado y mueble con cajones. 2 Enchufes eléctricos incluidos. Orme Cannelle T11 solamente.
- Barbierplatz. Dekorierter Spiegel. Möbel mit Schubladen mit integrierten Steckdosen. Nur Orme Cannelle.

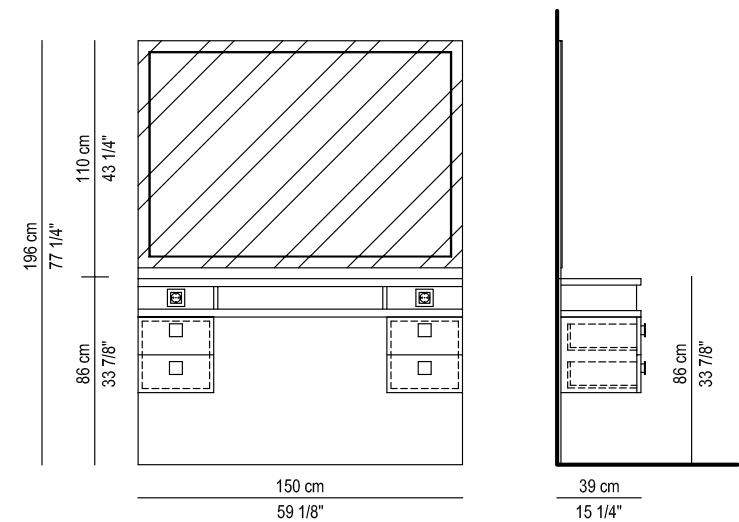

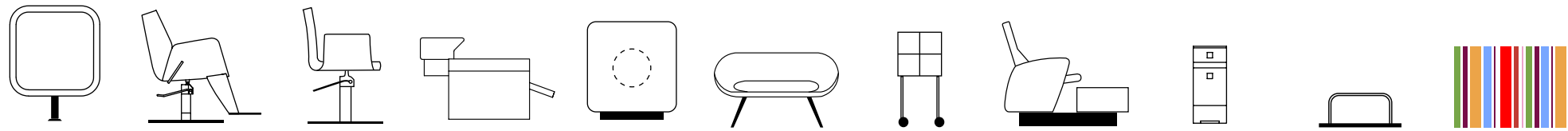

ELDORADO



MOUVEMENT ÉLECTRIQUE DE LA BATTERIE
BATTERIE RECHARGEABLE



ELDORADO LIFT R®

FB 529 LIFT

€ 6.983,00

- Fauteuil barbier avec pompe électrique blocable. Batterie rechargeable.
- Poltrona per uomo con pompa elettrica e blocco. Batteria ricaricabile.
- Barber chair with electric pump. Rechargeable battery.
- Sillon caballero con bomba eléctrica. Batería recargable.
- Barbierstuhl mit elektrischer Pumpe und Akku.

ELDORADO

FB 529

€ 4.935,00

- Fauteuil barbier avec pompe hydraulique blocable. Dossier inclinable et tête réglable. Repose-pieds chrome. Coloris de skai et du passepois au choix dans notre gamme.
- Poltrona per uomo con pompa idraulica e blocco. Schienale reclinabile con poggiatesta regolabile. Fronte poggipiedi cromato.
- Barber chair with hydraulic blockable pump. Reclining backrest and adjustable headrest. Chromed footrests..
- Sillón caballero con bomba hidráulica bloqueable. Respaldo reclinable y cabezal. Reposapiés de metal cromado.
- Barbierstuhl mit hydraulische Pumpe mit Blockierung. Verstellbarer Rückenlehne und höhenverstellbare Kopfstütze. Chromfußstütze.

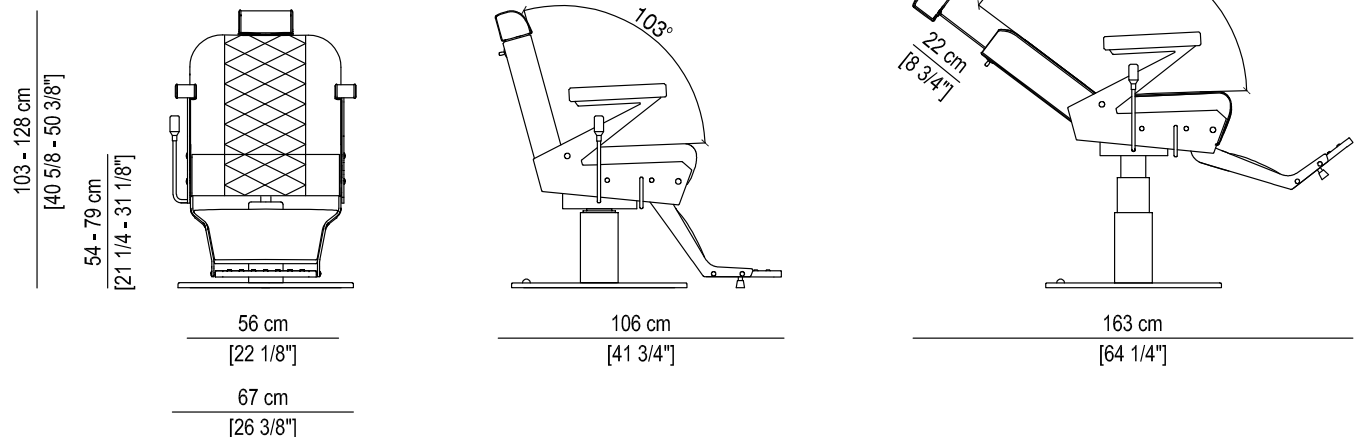

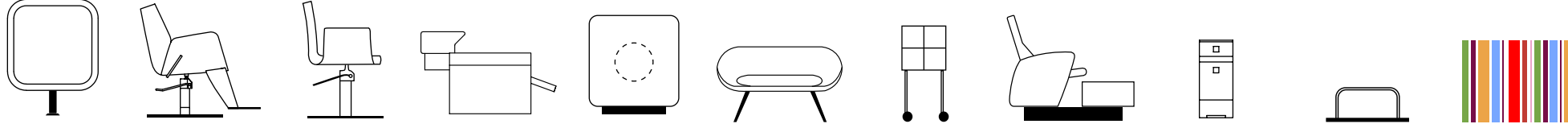

BOSS

BOSS FB 527

€ 3.717,00

- Fauteuil barbier avec pompe hydraulique blocable. Dossier inclinable et tête réglable. Repose-pieds noir en Aluminium.
- Poltrona per uomo con pompa e blocco. Schienale reclinabile con poggiatesta. Poggiapiedi in alluminio finitura nera.
- Barber chair with footrest and lockable hydraulic pump. Reclining backrest (reclining handle on the side) and headrest. Black Aluminium Footrest.
- Sillón caballero con bomba hidráulica bloqueable. Respaldo reclinable y cabezal ajustable. Reposapiés de aluminio negro.
- Barbierstuhl mit hydraulischer Pumpe mit Blockierung. Mit verstellbarer Rückenlehne (Griff an der Seite) und Kopfstütze. Schwarze Fußstütze aus Aluminium.

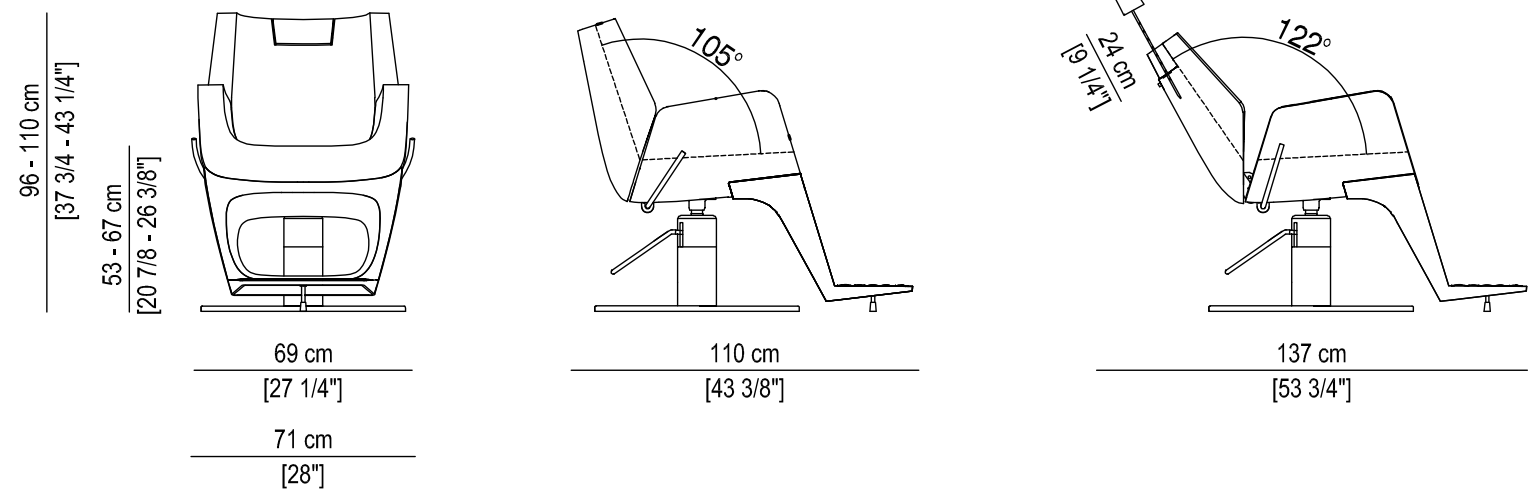

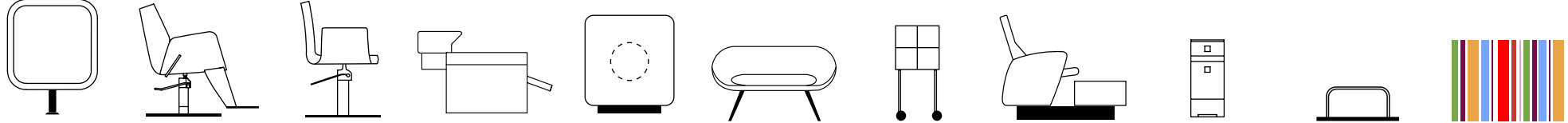

BOSS LIGHT

BOSS LIGHT

FB 527 L

€ 3.255,00

- Fauteuil barbier avec pompe hydraulique blocable. Dossier inclinable et tête. Repose-pieds noir en Aluminium.
- Poltrona per uomo con pompa e blocco. Schienale reclinabile con poggiatesta. Poggiapiedi in alluminio finitura nera.
- Barber chair with footrest and lockable hydraulic pump. Reclining backrest (reclining handle on the side) and headrest. Black Aluminium Footrest.
- Sillón caballero con bomba hidráulica bloqueable. Respaldo reclinable y cabezal. Reposapiés de aluminio negro.
- Barbierstuhl mit hydraulischer Pumpe mit Blockierung. Mit verstellbarer Rückenlehne (Griff an der Seite) und Kopfstütze. Schwarze Fußstütze aus Aluminium.



96 - 110 cm
[37 3/4 - 43 1/4"]

53 - 67 cm
[20 7/8 - 26 3/8"]

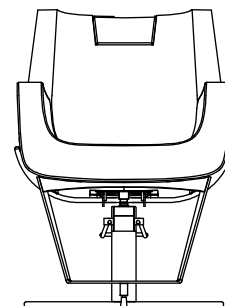

69 cm
[27 1/4"]

71 cm
[28"]

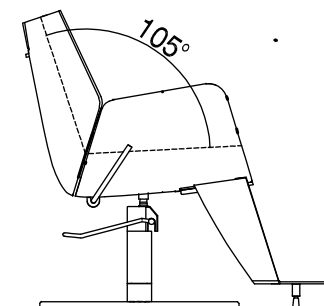

103 cm
[40 3/4"]

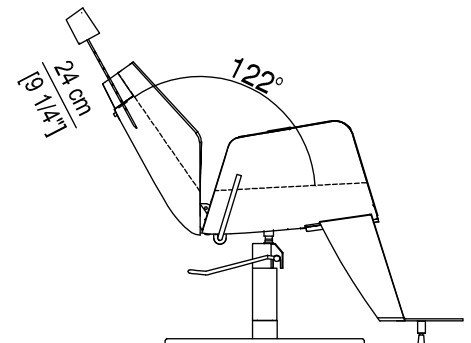

130 cm
[51 1/8"]

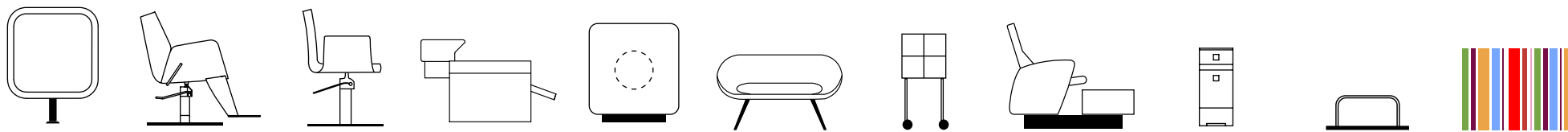

HIPSTER

HIPSTER FB 528

€ 4.179,00

- Fauteuil barbier avec pompe hydraulique blocable. Dossier inclinable et tête réglable. Repose-pieds en métal chromé.
- Poltrona per uomo con pompa e blocco. Schienale reclinabile con poggiatesta. Pedana poggiapiedi in metallo cromato lucido.
- Barber chair with footrest and lockable hydraulic pump. Reclining backrest (reclining handle on the side) and headrest. Chromed Metal Footrest.
- Sillón caballero con bomba hidráulica bloqueable. Respaldo reclinable y cabezal ajustable. Repospiés de metal cromado.
- Barbierstuhl mit hydraulischer Pumpe mit Blockierung. Mit verstellbarer Rückenlehne (Griff an der Seite) und Kopfstütze. Fußstütze aus verchromtem Metall.



104 - 124 cm
[41 - 48 3/4"]

54 - 74 cm
[21 1/4 - 29 1/8"]

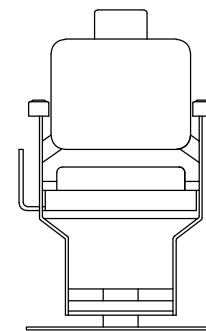

49 cm
[19 1/4"]

66 cm
[25 3/4"]

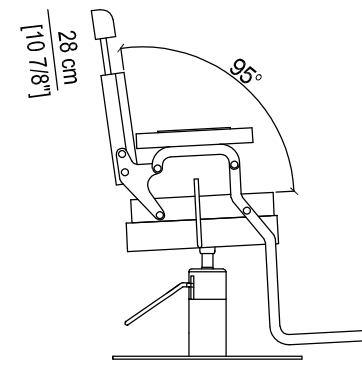

101 cm
[39 3/4"]

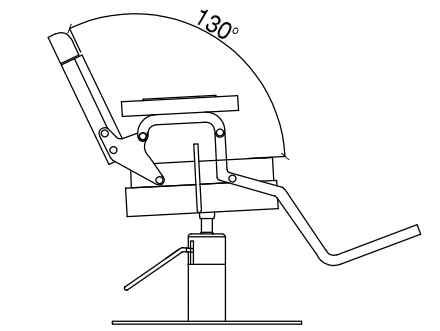

140 cm
[55"]

- * Modèle présenté avec skaï Luxe kilt 105: + 50€
- * Modello come in foto, con tessuto Luxe kilt 105: + 50€
- * Sillón presentado con tapizado Luxe kilt 105: + 50€
- * Seater presented in Kilt105: +50€
- * Sessel in Kilt105 vorgestellt: +50€

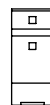
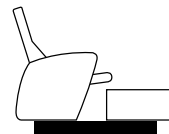
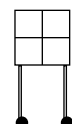
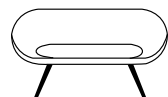
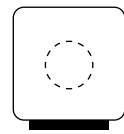
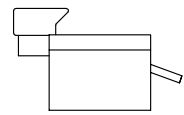
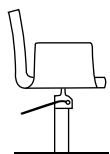
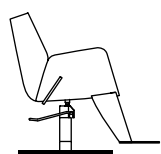
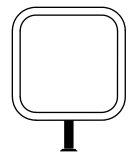

03

F A U T E U I L S

P O L T R O N E

C H A I R S

S I L L O N E S

S T Ü H L E



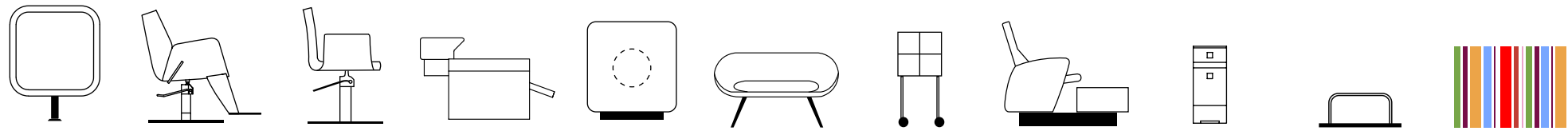

BEAUTY CHARME



- Fauteuil inclinable avec tête réglable en hauteur et inclinante, disponible avec pompe hydraulique blocable en version base ronde ou carrée avec le repose-pieds en option. Les coloris de skai et du passepoil au choix de notre gamme.
- Poltrona reclinabile con poggiatesta regolabile in altezza e basculante, disponibile con pompa idraulica bloccabile in versione base tonda o quadrata con poggiapiedi optional. Selezionare dalla nostra gamma i colori dello skai e del piping.
- Reclining chair with height-adjustable and tilting headrest, available with hydraulic, lockable pump in round or square base version with optional footrest. Choose from our fabric range for the upholstery and piping colours.
- Neigbarer Stuhl mit höhenverstellbarer und neigbarer Kopfstütze, erhältlich mit hydraulischer, feststellbarer Pumpe in runder oder quadratischer Fußausführung mit optionaler Fußstütze. Wählen Sie aus unserem Stoffsortiment für die Polster und Keder Farben.
- Sillón reclinable con reposacabezas inclinable y regulable en altura, disponible con bomba hidráulica bloqueable en versión de base redonda o cuadrada con reposapiés opcional. Los colores de skai y ribetes a elegir de nuestra gama.

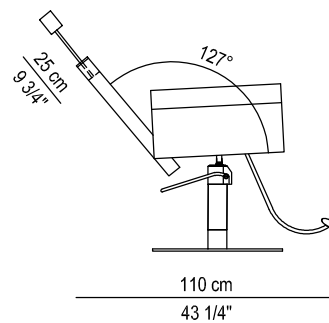
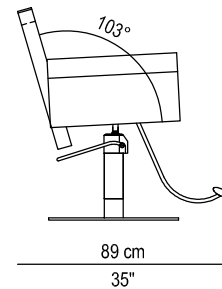
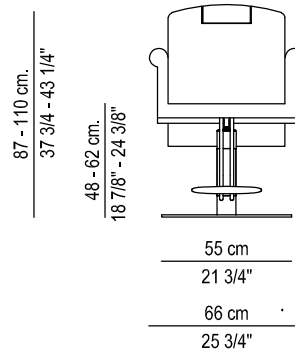

FB 235 YQ € 2.520,00

- Avec base carrée.
- Con base quadrata.
- With square base.
- Con base cuadrada.
- Mit Viereckigfuß.



FB 235 YR € 2.499,00

- Avec base ronde.
- Con base rotonda.
- With round base.
- Con base redonda.
- Mit Tellerfuß.



FB 235 YQ RP € 2.709,00

- Avec base carrée + Repose-pieds.
- Con base quadrata + appoggia piedi.
- With square base + footrest.
- Con base cuadrada + reposapiés.
- Mit Viereckigfuß + Fußstütze.



FB 235 YR RP € 2.688,00

- Avec base ronde + Repose-pieds.
- Con base rotonda + appoggia piedi.
- With round base + footrest.
- Con base redonda + reposapiés.
- Mit Tellerfuß + Fußstütze.



FB 235 HRN € 2.552,00

- BEAUTY CHARME HRN



FB 235 HRO € 2.552,00

- BEAUTY CHARME HRO

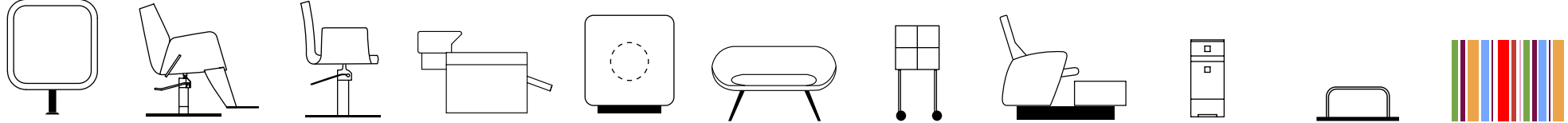

CHARME



FB 230 HRN
■ CHARME HRN

€ 1.030,00

FB 230 HRO
■ CHARME HRO

€ 1.030,00

Option tête disponible / Opzione poggiatesta disponibile / Headrest option available / Opción de reposacabezas disponible / Kopfstütze erhältlich

Fauteuil capitonné / Poltrona imbottita / Padded styling chair / Sillón acolchado / Gepolsterter Friseurstuhl



PYQ FB 230 YQ

€ 998,00

- Avec base carrée et pompe hydraulique blocable.
- Con base quadrata e pompa con blocco.
- With square base and hydraulic lockable pump.
- Con base cuadrada y bomba hidráulica bloqueable.
- Mit Viereckigfuß und hydraulischer Pumpe mit Blockierung.

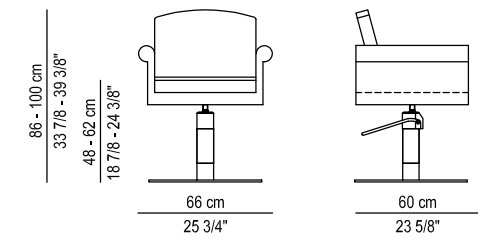

PYR FB 230 YR

€ 977,00

- Avec base ronde et pompe hydraulique blocable.
- Con base rotonda e pompa con blocco.
- With round base and hydraulic lockable pump.
- Con base redonda y bomba hidráulica bloqueable.
- Mit Tellerfuß und hydraulischer Pumpe mit Blockierung.

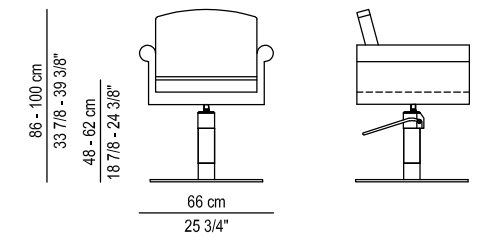

PYL FB 230 YL

€ 851,00

- Avec base aluminium et pompe hydraulique blocable.
- Con base alluminio e pompa con blocco.
- With cross base and hydraulic lockable pump.
- Con base de aluminio y bomba hidráulica bloqueable.
- Mit Kreuzfuß und hydraulischer Pumpe mit Blockierung.

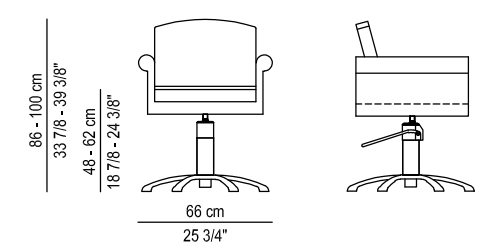

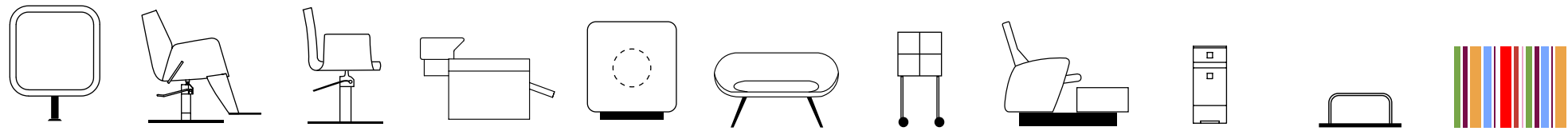

COSTE'S



FB 480 HRN

€ 1.166,00

FB 480 HRO

€ 1.166,00

■ COSTE'S HRN

■ COSTE'S HRO

Fauteuil en mousse injectée / Seduta imbottita, schienale schiumato / Chair from moulded foam / Sillón de espuma inyectada / Stuhl aus Formschaum

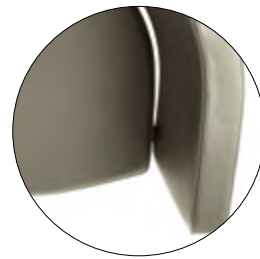

PYQ FB 480 YQ

€ 1.134,00

- Avec base carrée et pompe hydraulique blocable.
- Con base quadrata e pompa con blocco.
- With square base and hydraulic lockable pump.
- Con base cuadrada y bomba hidráulica bloqueable.
- Mit Viereckfuß und hydraulischer Pumpe mit Blockierung.

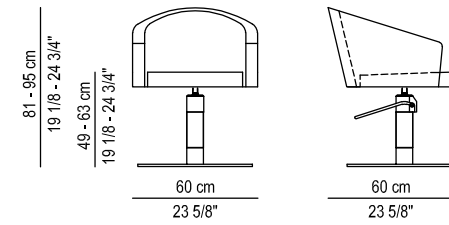

PYR FB 480 YR

€ 1.113,00

- Avec base ronde et pompe hydraulique blocable.
- Con base rotonda e pompa con blocco.
- With round base and hydraulic lockable pump.
- Con base redonda y bomba hidráulica bloqueable.
- Mit Tellerfuß und hydraulischer Pumpe mit Blockierung.

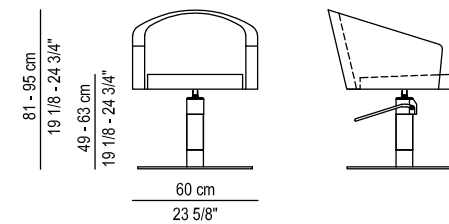

PYL FB 480 YL

€ 987,00

- Avec base aluminium et pompe hydraulique blocable.
- Con base alluminio e pompa con blocco.
- With cross base and hydraulic lockable pump.
- Con base de aluminio y bomba hidráulica bloqueable.
- Mit Kreuzfuß und hydraulischer Pumpe mit Blockierung.

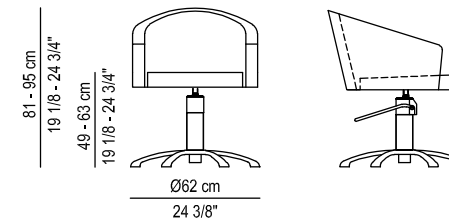

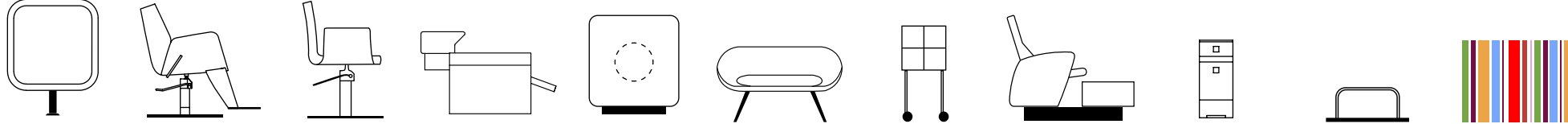

SUITE

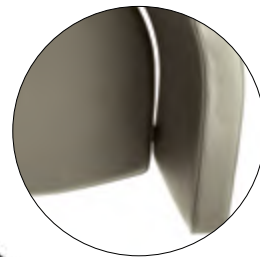

PYQ FB 440 YQ

€ 1.134,00

- Avec base carrée et pompe hydraulique blocable.
- Con base quadrata e pompa con blocco.
- With square base and hydraulic lockable pump.
- Con base cuadrada y bomba hidráulica bloqueable.
- Mit Viereckfuß und hydraulischer Pumpe mit Blockierung.

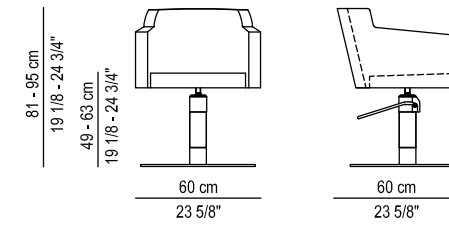

PYR FB 440 YR

€ 1.113,00

- Avec base ronde et pompe hydraulique blocable.
- Con base rotonda e pompa con blocco.
- With round base and hydraulic lockable pump.
- Con base redonda y bomba hidráulica bloqueable.
- Mit Tellerfuß und hydraulischer Pumpe mit Blockierung.

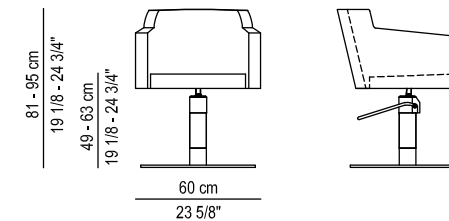

PYL FB 440 YL

€ 987,00

- Avec base aluminium et pompe hydraulique blocable.
- Con base alluminio e pompa con blocco.
- With cross base and hydraulic lockable pump.
- Con base de aluminio y bomba hidráulica bloqueable.
- Mit Kreuzfuß und hydraulischer Pumpe mit Blockierung.

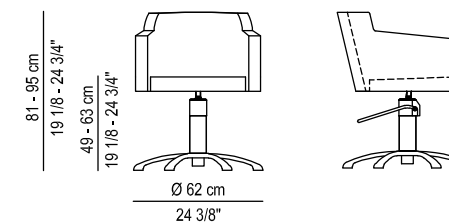

FB 440 HRN

€ 1.166,00

FB 440 HRO

€ 1.166,00

- SUITE HRN

- SUITE HRO

Option tête disponible / Opzione poggiatesta disponibile / Headrest option available / Opción de reposacabezas disponible / Kopfstütze erhältlich

Fauteuil en mousse injectée / Seduta imbottita, schienale schiumato / Chair from moulded foam / Sillón de espuma inyectada / Stuhl aus Formschaum

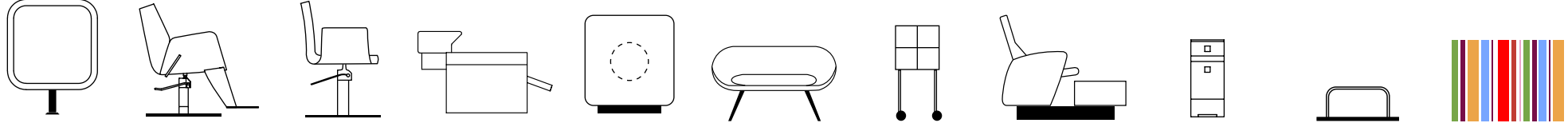

SUE



FB 740 HRN

■ SUE HRN

€ 1.019,00

FB 740 HRO

■ SUE HRO

€ 1.019,00



PYQ FB 740 YQ

€ 987,00

- Avec base carrée et pompe hydraulique blocable.
- Con base quadrata e pompa con blocco.
- With square base and hydraulic lockable pump.
- Con base cuadrada y bomba hidráulica bloqueable.
- Mit Viereckigfuß und hydraulischer Pumpe mit Blockierung.

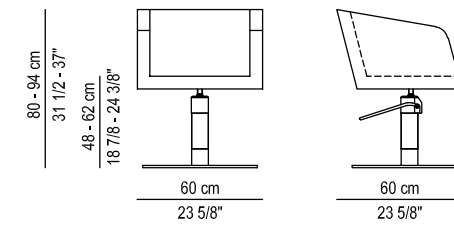

PYR FB 740 YR

€ 966,00

- Avec base ronde et pompe hydraulique blocable.
- Con base rotonda e pompa con blocco.
- With round base and hydraulic lockable pump.
- Con base redonda y bomba hidráulica bloqueable.
- Mit Tellerfuß und hydraulischer Pumpe mit Blockierung.

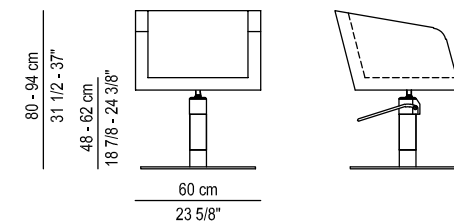

PYL FB 740 YL

€ 840,00

- Avec base aluminium et pompe hydraulique blocable.
- Con base alluminio e pompa con blocco.
- With cross base and hydraulic lockable pump.
- Con base de aluminio y bomba hidráulica bloqueable.
- Mit Kreuzfuß und hydraulischer Pumpe mit Blockierung.

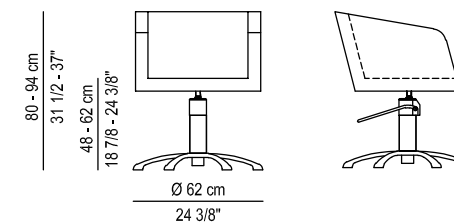

Fauteuil capitonné / Poltrona imbottita / Padded styling chair / Sillón acolchado / Gepolsterter Friseurstuhl

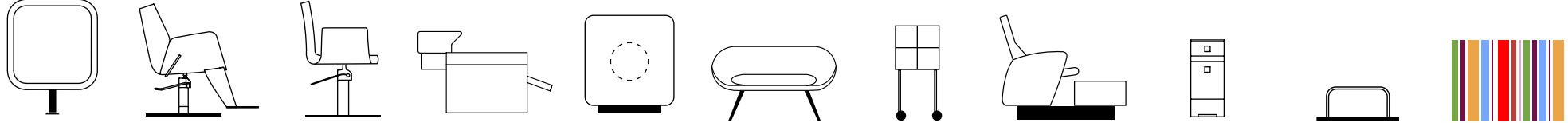

CUBE



FB 750 HRN

€ 977,00

FB 750 HRO

€ 977,00

■ CUBE HRN

■ CUBE HRO

Fauteuil capitonné / Poltrona imbottita / Padded styling chair / Sillón acolchado / Gepolsterter Friseurstuhl



PYQ FB 750 YQ

€ 945,00

- Avec base carrée et pompe hydraulique blocable.
- Con base quadrata e pompa con blocco.
- With square base and hydraulic lockable pump.
- Con base cuadrada y bomba hidráulica bloqueable.
- Mit Viereckigfuß und hydraulischer Pumpe mit Blockierung.

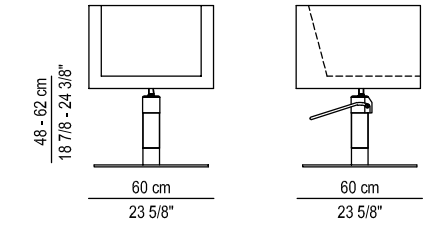

PYR FB 750 YR

€ 924,00

- Avec base ronde et pompe hydraulique blocable.
- Con base rotonda e pompa con blocco.
- With round base and hydraulic lockable pump.
- Con base redonda y bomba hidráulica bloqueable.
- Mit Tellerfuß und hydraulischer Pumpe mit Blockierung.

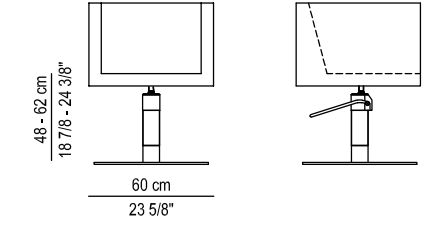

PYL FB 750 YL

€ 798,00

- Avec base aluminium et pompe hydraulique blocable.
- Con base alluminio e pompa con blocco.
- With cross base and hydraulic lockable pump.
- Con base de aluminio y bomba hidráulica bloqueable.
- Mit Kreuzfuß und hydraulischer Pumpe mit Blockierung.

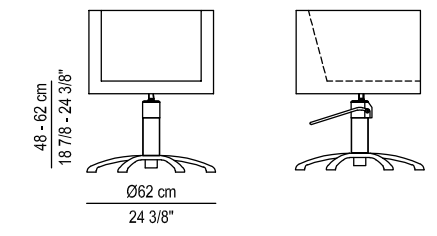

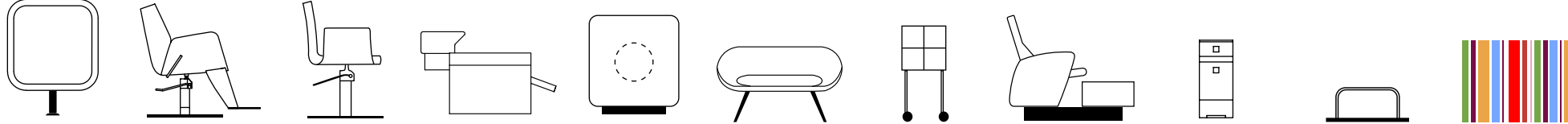

DIAMANT



PYQ FB 710 YQ

€ 1.281,00

- Avec base carrée et pompe hydraulique blocable haut-de-gamme.
- Con base quadrata e pompa con blocco alta qualità.
- With square base and high quality hydraulic lockable pump.
- Con base cuadrada y bomba hidráulica bloqueable de alta gama.
- Mit Viereckigfuß und hochwertiger hydraulischer Pumpe mit Blockierung.

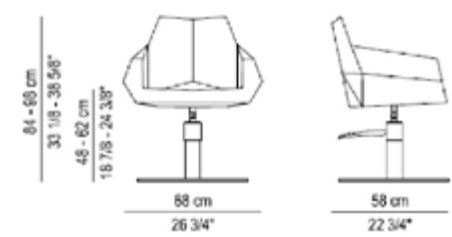

PYR FB 710 YR

€ 1.260,00

- Avec base ronde et pompe hydraulique blocable haut-de-gamme.
- Con base rotonda e pompa con blocco alta qualità.
- With round base and high quality hydraulic lockable pump.
- Con base redonda y bomba hidráulica bloqueable de alta gama.
- Mit Tellerfuß und hochwertige hydraulische Pumpe mit Blockierung.

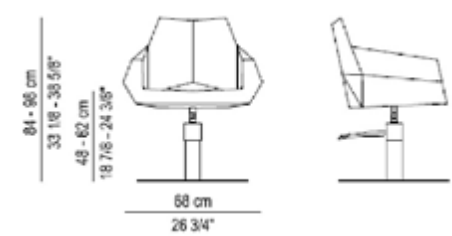

PYL FB 710 YL

€ 1.134,00

- Avec base aluminium et pompe hydraulique blocable haut-de-gamme.
- Con base alluminio e pompa con blocco alta qualità.
- With cross base and high quality hydraulic lockable pump.
- Con base de aluminio y bomba hidráulica bloqueable de alta gama.
- Mit Kreuzfuß und hochwertiger hydraulischer Pumpe mit Blockierung.

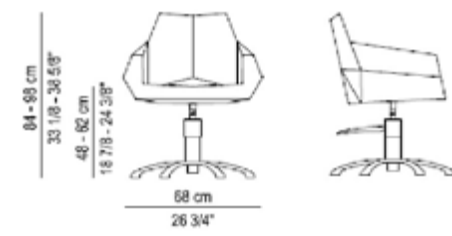

FB 710 HRN

€ 1.313,00



FB 710 HRO

€ 1.313,00

■ DIAMANT HRN

■ DIAMANT HRO

Fauteuil en mousse injectée / Poltrona schiumata / Chair from moulded foam / Sillón de espuma inyectada / Stuhl aus Formschaum

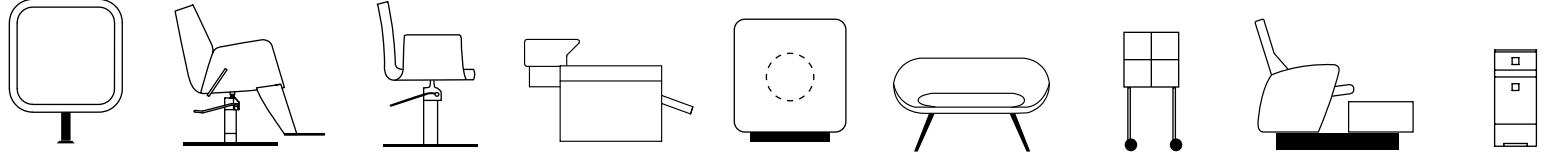

TORTUE



PYQ FB 730 YQ

€ 945,00

- Avec base carrée et pompe hydraulique blocable.
- Con base quadrata e pompa con blocco.
- With square base and hydraulic lockable pump.
- Con base cuadrada y bomba hidráulica bloqueable.
- Mit Viereckigfuß und hydraulischer Pumpe mit Blockierung.

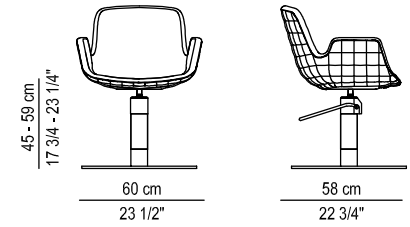

PYR FB 730 YR

€ 924,00

- Avec base ronde et pompe hydraulique blocable.
- Con base rotonda e pompa con blocco.
- With round base and hydraulic lockable pump.
- Con base redonda y bomba hidráulica bloqueable.
- Mit Tellerfuß und hydraulische Pumpe mit Blockierung.

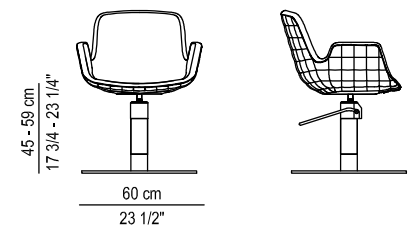

PYL FB 730 YL

€ 798,00

- Avec base aluminium et pompe hydraulique blocable.
- Con base alluminio e pompa con blocco.
- With cross base and hydraulic lockable pump.
- Con base de aluminio y bomba hidráulica bloqueable.
- Mit Kreuzfuß und hydraulischer Pumpe mit Blockierung.

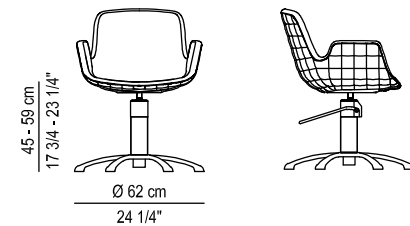

FB 730 HRN

€ 977,00

FB 730 HRO

€ 977,00

■ TORTUE HRN

■ TORTUE HRO

Fauteuil design en polyuréthane noir / Poltrona interamente in poliuretano integrale autopellante. Disegno esclusivo Nelson / Chair in black polyurethane / Sillón de poliuretano negro / Stuhl aus schwarzem Polyurethan

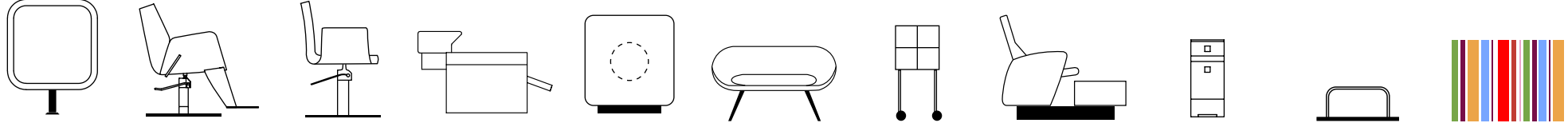

OPEN



PYQ FB 220 YQ

€ 956,00

- Avec base carrée et pompe hydraulique blocable.
- Con base quadrata e pompa con blocco.
- With square base and hydraulic lockable pump.
- Con base cuadrada y bomba hidráulica bloqueable.
- Mit Viereckigfuß und hydraulischer Pumpe mit Blockierung.

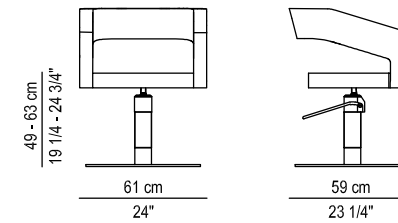

PYR FB 220 YR

€ 935,00

- Avec base ronde et pompe hydraulique blocable.
- Con base rotonda e pompa con blocco.
- With round base and hydraulic lockable pump.
- Con base redonda y bomba hidráulica bloqueable.
- Mit Tellerfuß und hydraulische Pumpe mit Blockierung.

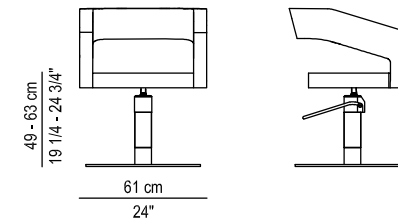

PYL FB 220 YL

€ 809,00

- Avec base aluminium et pompe hydraulique blocable.
- Con base alluminio e pompa con blocco.
- With cross base and hydraulic lockable pump.
- Con base de aluminio y bomba hidráulica bloqueable.
- Mit Kreuzfuß und hydraulischer Pumpe mit Blockierung.

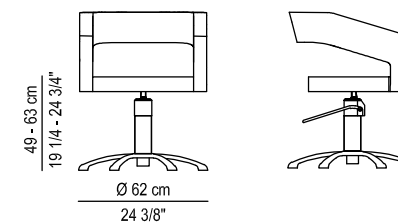

FB 220 HRN

€ 988,00



FB 220 HRO

€ 988,00

- OPEN HRN

- OPEN HRN

Option tête disponible / Opzione poggiatesta disponibile / Headrest option available / Opción de reposacabezas disponible / Kopfstütze erhältlich

Fauteuil capitonné avec dossier aéré et assise en mousse injectée / Seduta imbottita, schienale schiumato / Padded styling chair from moulded foam / Sillón alcohado con respaldo abierto y asiento de espuma injectada / Gepolsterter Sessel mit Rückenlehne aus Formschaum

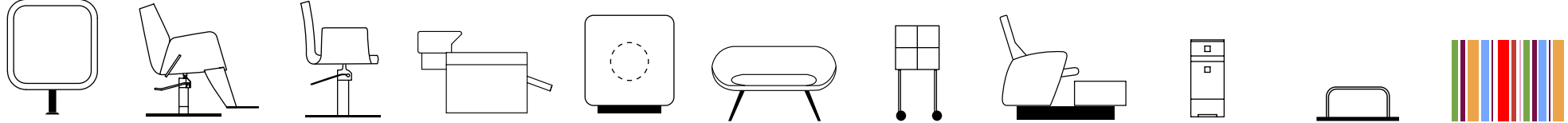

AURIAN



PYQ FB 720 YQ

€ 1.040,00

- Avec base carrée et pompe hydraulique blocable.
- Con base quadrata e pompa con blocco.
- With square base and hydraulic lockable pump.
- Con base cuadrada y bomba hidráulica bloqueable.
- Mit Viereckigfuß und hydraulischer Pumpe mit Blockierung.

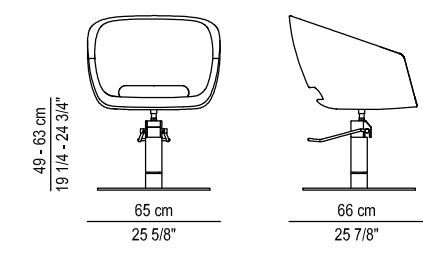

PYR FB 720 YR

€ 1.019,00

- Avec base ronde et pompe hydraulique blocable.
- Con base rotonda e pompa con blocco.
- With round base and hydraulic lockable pump.
- Con base redonda y bomba hidráulica bloqueable.
- Mit Tellerfuß und hydraulische Pumpe mit Blockierung.

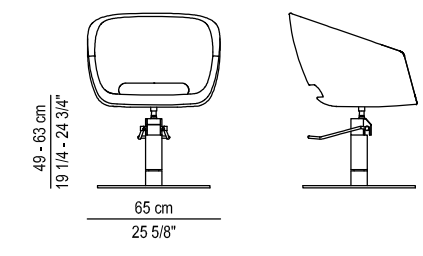

PYL FB 720 YL

€ 893,00

- Avec base aluminium et pompe hydraulique blocable.
- Con base alluminio e pompa con blocco.
- With cross base and hydraulic lockable pump.
- Con base de aluminio y bomba hidráulica bloqueable.
- Mit Kreuzfuß und hydraulischer Pumpe mit Blockierung.

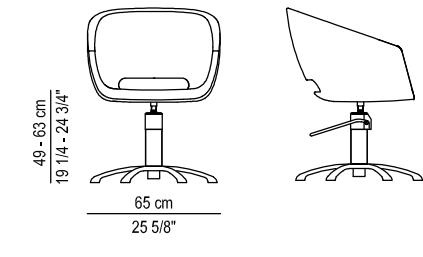

FB 720 HRN

■ AURIAN HRN

€ 1.072,00



FB 720 HRO

■ AURIAN HRO

€ 1.072,00

Fauteuil en mousse injectée / Poltrona schiumata / Chair from moulded foam /
Sillón de espuma inyectada / Stuhl aus Formschaum

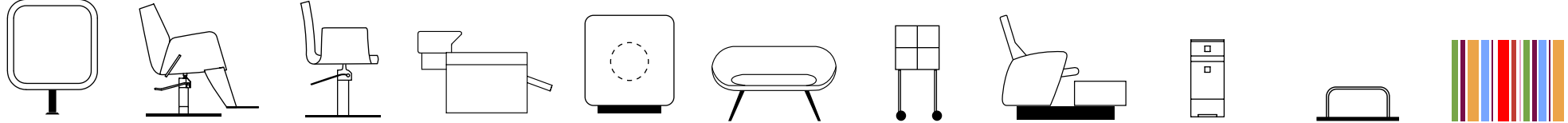

ISOKA



PYQ FB 130 YQ

€ 945,00

- Avec base carrée et pompe hydraulique blocable.
- Con base quadrata e pompa con blocco.
- With square base and hydraulic lockable pump.
- Con base cuadrada y bomba hidráulica bloqueable.
- Mit Viereckigfuß und hydraulischer Pumpe mit Blockierung.

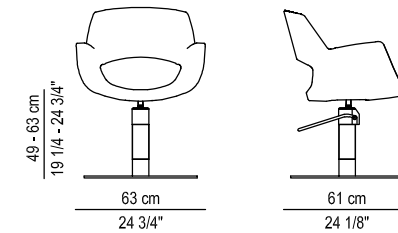

PYR FB 130 YR

€ 924,00

- Avec base ronde et pompe hydraulique blocable.
- Con base rotonda e pompa con blocco.
- With round base and hydraulic lockable pump.
- Con base redonda y bomba hidráulica bloqueable.
- Mit Tellerfuß und hydraulischer Pumpe mit Blockierung.

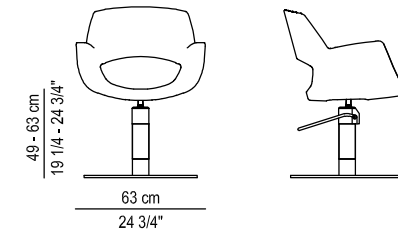

PYL FB 130 YL

€ 798,00

- Avec base aluminium et pompe hydraulique blocable.
- Con base alluminio e pompa con blocco.
- With cross base and hydraulic lockable pump.
- Con base de aluminio y bomba hidráulica bloqueable.
- Mit Kreuzfuß und hydraulischer Pumpe mit Blockierung.

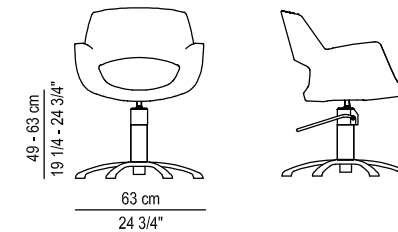

FB 130 HRN

- ISOKA HRN

€ 977,00



FB 130 HRO

- ISOKA HRO

€ 977,00

Fauteuil en mousse injectée / Poltrona schiumata / Chair from moulded foam /
Sillón de espuma inyectada / Stuhl aus Formschaum

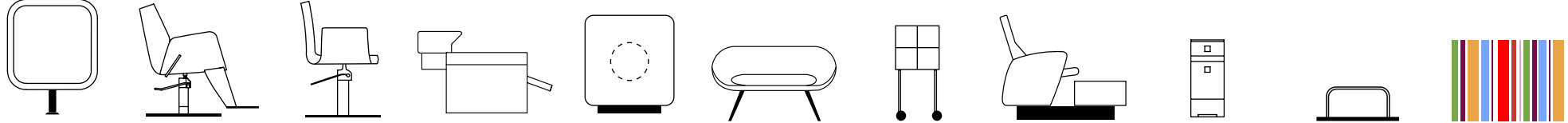

BARBIZON



PYQ FB 100 YQ

€ 882,00

- Avec base carrée et pompe hydraulique blocable.
- Con base quadrata e pompa con blocco.
- With square base and hydraulic lockable pump.
- Con base cuadrada y bomba hidráulica bloqueable.
- Mit Viereckigfuß und hydraulischer Pumpe mit Blockierung.

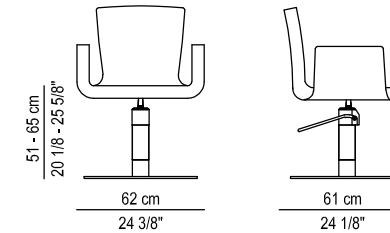

PYR FB 100 YR

€ 861,00

- Avec base ronde et pompe hydraulique blocable.
- Con base rotonda e pompa con blocco.
- With round base and hydraulic lockable pump.
- Con base redonda y bomba hidráulica bloqueable.
- Mit Tellerfuß und hydraulischer Pumpe mit Blockierung.

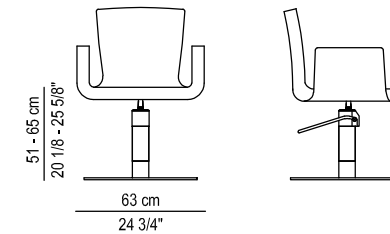

PYL FB 100 YL

€ 735,00

- Avec base aluminium et pompe hydraulique blocable.
- Con base alluminio e pompa con blocco.
- With cross base and hydraulic lockable pump.
- Con base de aluminio y bomba hidráulica bloqueable.
- Mit Kreuzfuß und hydraulischer Pumpe mit Blockierung.

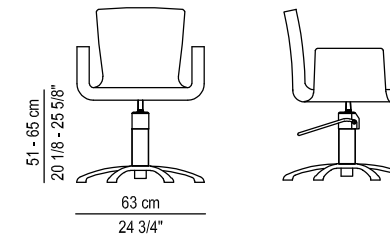

FB 100 HRN

€ 914,00



FB 100 HRO

€ 914,00

■ BARBIZON HRN

■ BARBIZON HRO

Fauteuil en mousse injectée / Poltrona schiumata / Chair from moulded foam /
Sillón de espuma inyectada / Stuhl aus Formschaum

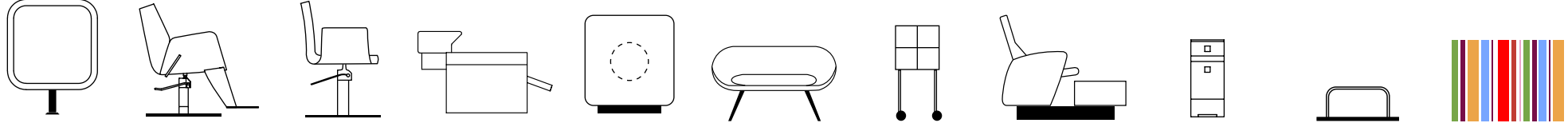

BABOU 2.0



FB 422 HRN
■ BABOU 2.0 HRN



FB 422 HRO
■ BABOU 2.0 HRO

Fauteuil en mousse injectée / Poltrona schiumata / Chair from moulded foam /
Sillón de espuma inyectada / Stuhl aus Formschaum



PYQ FB 422 YQ € 935,00

- Avec base carrée et pompe hydraulique blocable.
- Con base quadrata e pompa con blocco.
- With square base and hydraulic lockable pump.
- Con base cuadrada y bomba hidráulica bloqueable.
- Mit Viereckigfuß und hydraulischer Pumpe mit Blockierung.

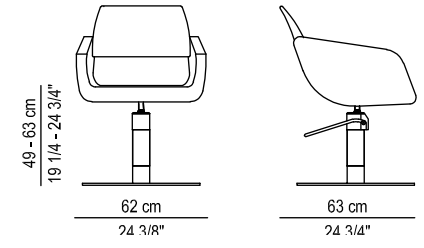

PYR FB 422 YR € 914,00

- Avec base ronde et pompe hydraulique blocable.
- Con base rotonda e pompa con blocco.
- With round base and hydraulic lockable pump.
- Con base redonda y bomba hidráulica bloqueable.
- Mit Tellerfuß und hydraulischer Pumpe mit Blockierung.

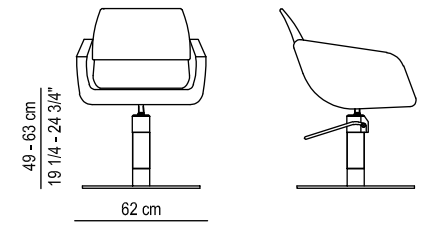

PYL FB 422 YL € 788,00

- Avec base aluminium et pompe hydraulique blocable.
- Con base alluminio e pompa con blocco.
- With cross base and hydraulic lockable pump.
- Con base de aluminio y bomba hidráulica bloqueable.
- Mit Kreuzfuß und hydraulischer Pumpe mit Blockierung.

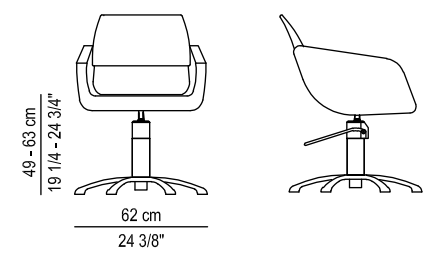

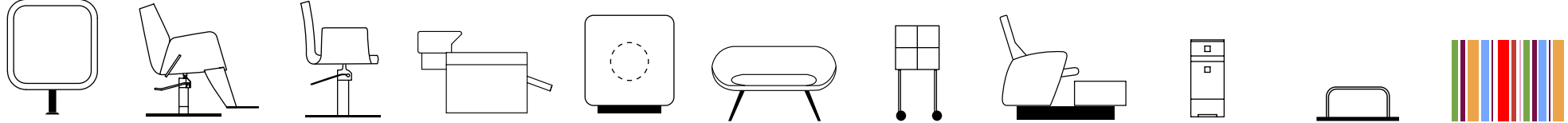

MANIA



PYQ FB 150 YQ € 840,00

- Avec base carrée et pompe hydraulique blocable.
- Con base quadrata e pompa con blocco.
- With square base and hydraulic lockable pump.
- Con base cuadrada y bomba hidráulica bloqueable.
- Mit Viereckigfuß und hydraulischer Pumpe mit Blockierung.

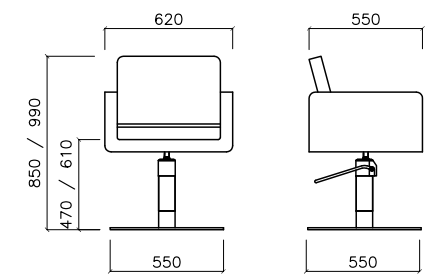

PYR FB 150 YR € 819,00

- Avec base ronde et pompe hydraulique blocable.
- Con base rotonda e pompa con blocco.
- With round base and hydraulic lockable pump.
- Con base redonda y bomba hidráulica bloqueable.
- Mit Tellerfuß und hydraulischer Pumpe mit Blockierung.

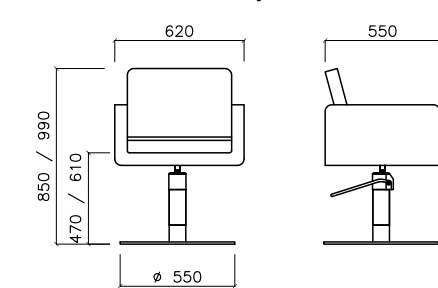

PYL FB 150 YL € 693,00

- Avec base aluminium et pompe hydraulique blocable.
- Con base alluminio e pompa con blocco.
- With cross base and hydraulic lockable pump.
- Con base de aluminio y bomba hidráulica bloqueable.
- Mit Kreuzfuß und hydraulischer Pumpe mit Blockierung.

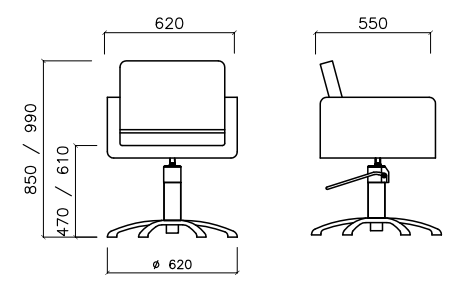

FB 150 HRN

- MANIA HRO

Option tête disponible / Opzione poggiatesta disponibile / Headrest option available / Opción de reposacabezas disponible / Kopfstütze erhältlich



FB 150 HRO

- MANIA HRN

Fauteuil capitonné / Poltrona imbottita / Padded styling chair / Sillón acolchado / Gepolsterter Friseurstuhl

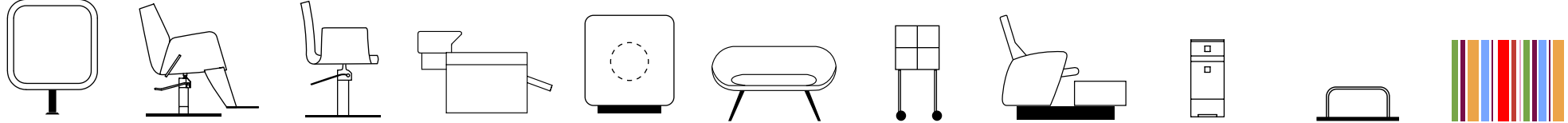

BOWY



PYQ FB 410 YQ

€ 935,00

- Avec base carrée et pompe hydraulique blocable.
- Con base quadrata e pompa con blocco.
- With square base and hydraulic lockable pump.
- Con base cuadrada y bomba hidráulica bloqueable.
- Mit Viereckigfuß und hydraulischer Pumpe mit Blockierung.

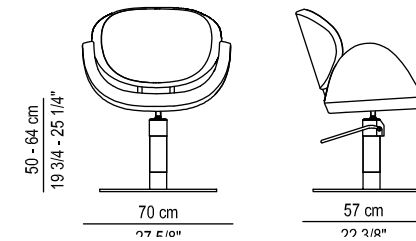

PYR FB 410 YR

€ 914,00

- Avec base ronde et pompe hydraulique blocable.
- Con base rotonda e pompa con blocco.
- With round base and hydraulic lockable pump.
- Con base redonda y bomba hidráulica bloqueable.
- Mit Tellerfuß und hydraulischer Pumpe mit Blockierung.

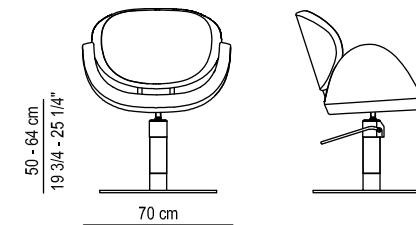

PYL FB 410 YL

€ 788,00

- Avec base aluminium et pompe hydraulique blocable.
- Con base alluminio e pompa con blocco.
- With cross base and hydraulic lockable pump.
- Con base de aluminio y bomba hidráulica bloqueable.
- Mit Kreuzfuß und hydraulischer Pumpe mit Blockierung.

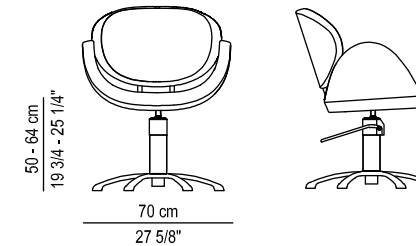

FB 410 HRN

- BOWY HRN



€ 967,00 FB 410 HRO

- BOWY HRO

€ 967,00

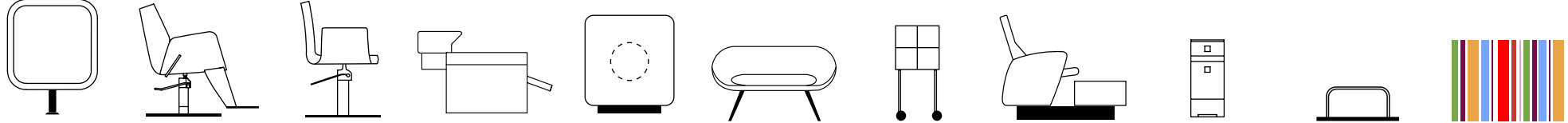

COSY



PYQ FB 400 YQ

€ 756,00

- Avec base carrée et pompe hydraulique blocable.
- Con base quadrata e pompa con blocco.
- With square base and hydraulic lockable pump.
- Con base cuadrada y bomba hidráulica bloqueable.
- Mit Viereckigfuß und hydraulischer Pumpe mit Blockierung.

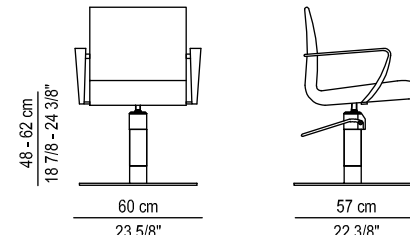

PYR FB 400 YR

€ 735,00

- Avec base ronde et pompe hydraulique blocable.
- Con base rotonda e pompa con blocco.
- With round base and hydraulic lockable pump.
- Con base redonda y bomba hidráulica bloqueable.
- Mit Tellerfuß und hydraulischer Pumpe mit Blockierung.

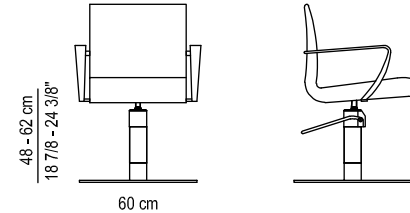

PYL FB 400 YL

€ 609,00

- Avec base aluminium et pompe hydraulique blocable.
- Con base alluminio e pompa con blocco.
- With cross base and hydraulic lockable pump.
- Con base de aluminio y bomba hidráulica bloqueable.
- Mit Kreuzfuß und hydraulischer Pumpe mit Blockierung.

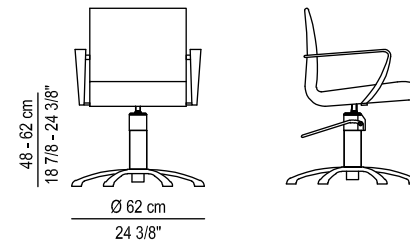

FB 400 HRN

€ 788,00



FB 400 HRO

€ 788,00

- COSY HRN

- COSY HRO

Fauteuil capitonné avec accoudoirs en aluminium, finition mate / Poltrona imbottita con braccioli in alluminio finitura opaca / Padded styling chair with matt aluminium armrests / Sillón de espuma tapizada con brazos de aluminio, acabado mate / Gepolsterter Friseurstuhl mit Armlehnen aus Mattaluminium

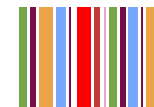
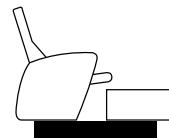
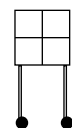
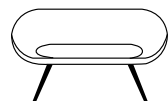
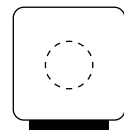
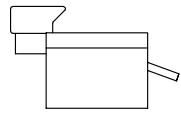
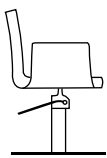
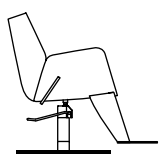
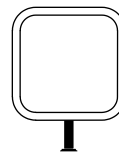

TEACH



- Fauteuil spécial école avec système rabattable pour tête malléable intégré dans le dossier
- Poltrona speciale scuola con supporto mobile per testine
- Specific chair for schools, with a pull-down system for training heads
- Sillón especial para prácticas con soporte abatible para cabeza de maniquí
- Stuhl für Schulen, mit einen klappbaren System für Übungsköpfe



PYQ FB 430 YQ

€ 1.050,00

- Avec base carrée et pompe hydraulique blocable.
- Con base quadrata e pompa con blocco.
- With square base and hydraulic lockable pump.
- Con base cuadrada y bomba hidráulica bloqueable.
- Mit Viereckigfuß und hydraulischer Pumpe mit Blockierung.

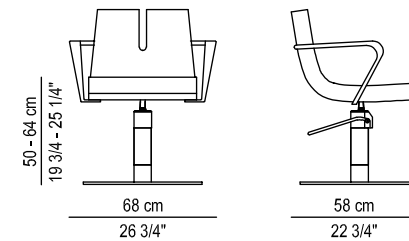

PYR FB 430 YR

€ 1.029,00

- Avec base ronde et pompe hydraulique blocable.
- Con base rotonda e pompa con blocco.
- With round base and hydraulic lockable pump.
- Con base redonda y bomba hidráulica bloqueable.
- Mit Tellerfuß und hydraulischer Pumpe mit Blockierung.

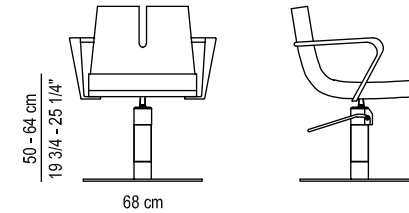

PYL FB 430 YL

€ 903,00

- Avec base aluminium et pompe hydraulique blocable.
- Con base alluminio e pompa con blocco.
- With cross base and hydraulic lockable pump.
- Con base de aluminio y bomba hidráulica bloqueable.
- Mit Kreuzfuß und hydraulischer Pumpe mit Blockierung.

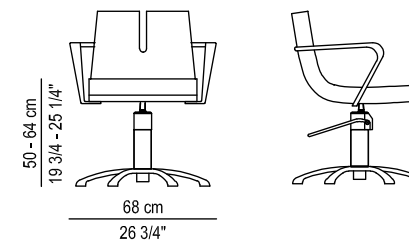

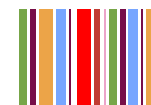
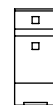
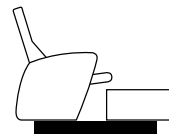
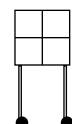
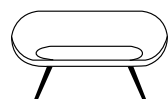
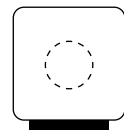
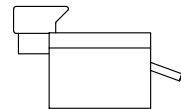
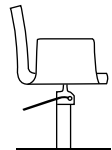
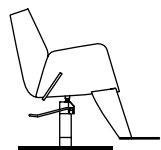
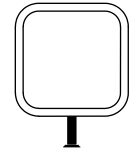

IRON BAR



IRON BAR

FE 05

€ 662,00

- Tabouret avec repose-pieds intégré. Pompe gaz et base carrée.
- Sgabello con poggiapiedi integrato. Pompa a gas Base quadrata.
- Stool with integrated footrest, gas pump and square base.
- Taburete con reposapiés integrado. Bomba de gas y base cuadrada.
- Hocker mit integrierter Fußstütze. Gaspumpe Viereckigfuß.



73 - 99 cm

28 3/4 - 39"

57 - 83 cm

22 3/8 - 32 3/4"

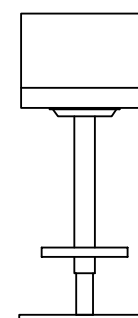

38 cm
14 7/8"

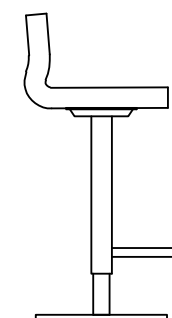

38 cm
14 7/8"

IRON STOOL



IRON STOOL

FE 04

€ 494,00

- Tabouret de coupe.
- Sgabello da taglia.
- Cutting stool.
- Taburete de corte.
- Rollhocker.

79 - 97 cm

31 1/8 - 38 1/4"

57 - 75 cm

22 3/8 - 29 1/2"

37 cm
14 5/8"

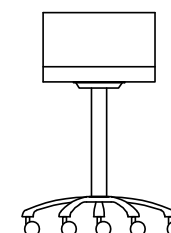

Ø 47 cm
18 5/8"

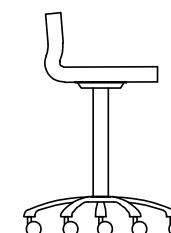

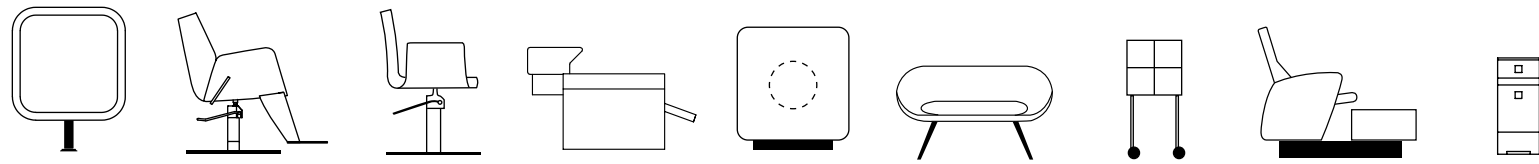

LONGCHAMP



SOFT

LONGCHAMP

FE 10

€ 452,00

- Tabouret avec piétement en aluminium poli et pompe à gaz.
- Sgabello con base in alluminio lucidato e pompa a gas.
- Stool with polished aluminium base and gas pump.
- Taburete con bomba de gas y base de aluminio pulido.
- Rollhocker. Untergestell aus poliertem Aluminium und Gaspumpe.

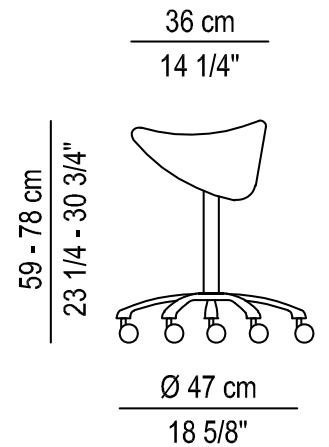

SOFT

FE 01

€ 231,00

- Tabouret avec assise épaisse. Pompe gaz.
- Sgabello con sedile imbottito e pompa a gas.
- Stool with extra padded seat. Gas pump.
- Taburete con bomba de gas. Asiento grueso.
- Rollhocker mit dickem Sitz. Gaspumpe.

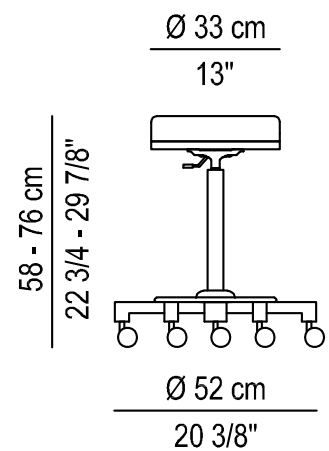
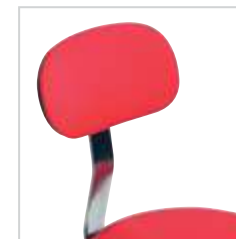

DOSSIER TABOURET

FE 03

€ 168,00

- Dossier pour tabouret SOFT/BANZAI.
- Schienale sgabello SOFT/BANZAI.
- Backrest for stool SOFT/BANZAI.
- Respaldo taburete SOFT/BANZAI.
- Rückenlehne für Rollhocker SOFT/BANZAI.

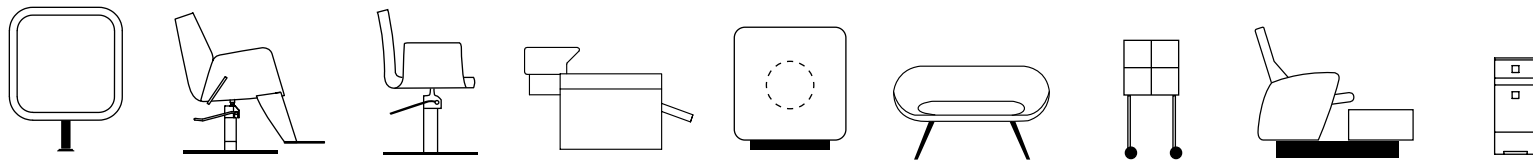

BANZAI



EKO

BANZAI

FE 02

€ 221,00

- Tabouret avec pompe gaz.
- Sgabello con pompa a gas.
- Stool with gas pump.
- Taburete con bomba de gas.
- Rollhocker mit Gaspumpe.

EKO

FE 02 ECO

€ 168,00

- Tabouret avec pompe gaz. Seulement en skai Noir.
- Sgabello da taglio. Skai nero unicamente.
- Cutting stool with Gas pump. Only black upholstery.
- Taburete con bomba de gas. Tapizado negro unicamente.
- Rollhocker mit Gaspumpe. Nur schwarzer Bezug.

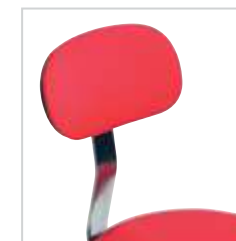
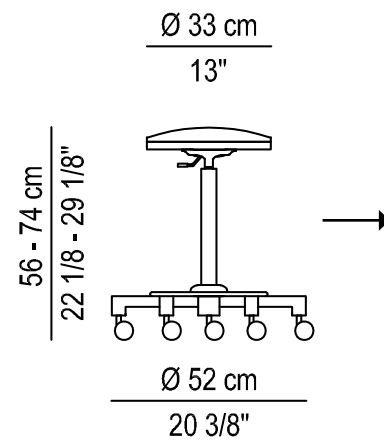

DOSSIER TABOURET

FE 03

€ 168,00

- Dossier pour tabouret SOFT/BANZAI.
- Schienale sgabello SOFT/BANZAI.
- Backrest for stool SOFT/BANZAI.
- Respaldo para taburete SOFT/BANZAI.
- Rückenlehne für Rollhocker SOFT/BANZAI.

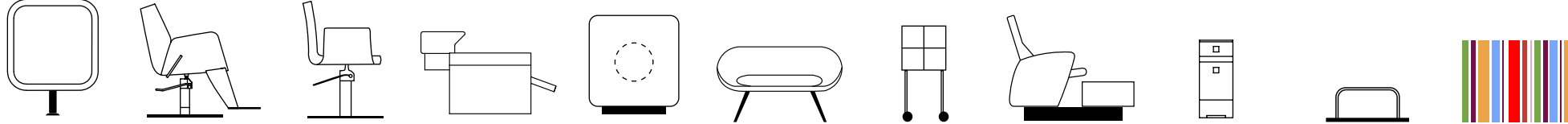

PYL

€ 231,00

- Base aluminium et pompe hydraulique blocable.
- Base alluminio e pompa con blocco.
- Cross base and hydraulic lockable pump.
- Base de aluminio y bomba hidráulica bloqueable.
- Kreuzfuß und hydraulische Pumpe mit Blockierung.



PWL

€ 431,00

- Base aluminium et pompe hydraulique blocable haut-de-gamme.
- Base alluminio e pompa con blocco alta qualità. Cross base and high quality hydraulic lockable pump.
- Base de aluminio y bomba hidráulica bloqueable gama alta.
- Kreuzfuß und hochwertige hydraulische Pumpe mit Blockierung.



PYR

€ 357,00

- Base ronde et pompe hydraulique blocable.
- Base rotonda e pompa con blocco.
- Round base and hydraulic lockable pump.
- Base redonda y bomba hidráulica bloqueable.
- Tellerfuß und hydraulische Pumpe mit Blockierung.



PWR

€ 557,00

- Base ronde et pompe hydraulique blocable haut-de-gamme.
- Base rotonda e pompa con blocco alta qualità.
- Round base and high quality hydraulic lockable pump.
- Base redonda y bomba hidráulica bloqueable gama alta.
- Tellerfuß und hochwertige hydraulische Pumpe mit Blockierung.



PYQ

€ 378,00

- Base carrée et pompe hydraulique blocable.
- Base quadrata e pompa con blocco.
- Square base and hydraulic lockable pump.
- Base cuadrada y bomba hidráulica bloqueable.
- Viereckigfuß und hydraulische Pumpe mit Blockierung.



PWQ

€ 578,00

- Base carrée et pompe hydraulique blocable haut-de-gamme.
- Base quadrata e pompa con blocco alta qualità.
- Square base and high quality hydraulic lockable pump.
- Base cuadrada y bomba hidráulica bloqueable gama alta.
- Viereckigfuß und hochwertige hydraulische Pumpe mit Blockierung.

PY

€ 140,00

- Pompe hydraulique blocable.
- Pompa con blocco.
- Hydraulic lockable pump.
- Bomba hidráulica bloqueable.
- Hydraulische Pumpe mit Blockierung.

PW

€ 338,00

- Pompe hydraulique haut-de-gamme.
- Pompa con blocco alta qualità.
- High quality hydraulic lockable pump.
- Bomba hidráulica bloqueable de gama alta.
- Hochwertige hydraulische Pumpe mit Blockierung.

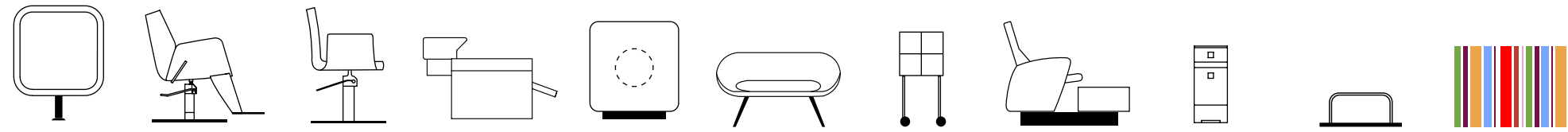

OPTION BASE CARREE **MATE**

OBCM

€ 00,00

- Sans supplément: base carrée mate.
- Senza supplemento: base quadrata in acciaio satinato.
- Free of charge: square base in matt steel.
- Sin suplemento: base cuadrada acero mate.
- Ohne Aufpreis: Viereckigfuß aus Mattstahl.



OPTION BASE NOIRE

HRN

€ 410,00



OPTION BASE RONDE **MATE**

OBRM

€ 00,00

- Sans supplément: base ronde mate.
- Senza supplemento: base rotonda in acciaio satinato.
- Free of charge: round base in matt steel.
- Sin suplemento: base redonda acero mate.
- Ohne Aufpreis: Tellerfuß aus Mattstahl.



OPTION BASE OR

HRO

€ 410,00

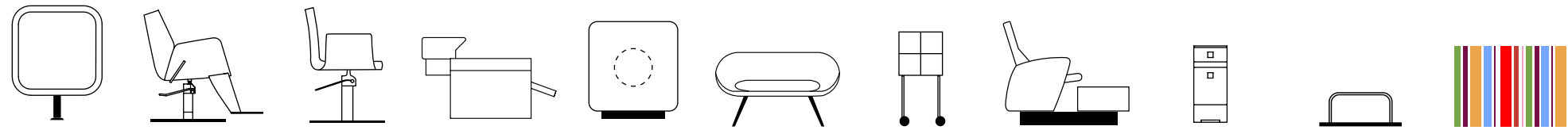

HOUSSE DE PROTECTION LUXE

FB HTL

€ 52,00

- Housse de protection luxe.
- Copertina di protezione luxe.
- Protective cover luxe.
- Funda de protecció n luxe.
- Schutzhülle Luxe.

CUBE, OPEN, SUE

€ 74,00

COSTE'S

€ 95,00



LIFT

FBPLIFT

€ 2.587,00

- Base réglable électriquement en hauteur (40-63cm) par batterie, pivotante à 360 degrés et blocable. Batterie, aux ions de lithium, rechargeable par alimentation directe 110/240 VAC 50-60Hz. Disponible pour les fauteuils Barbizon, Cube, Eldorado, Mania, Open, Sue et Suite.
- Base regolabile elettricamente in altezza (40-63cm) tramite batteria, girevole a 360 gradi e bloccabile. Batteria, agli ioni di litio, ricaricabile tramite alimentazione diretta 110/240 VAC 50-60Hz. Disponibile per le poltrone Barbizon, Cube, Eldorado, Mania, Open, Sue e Suite.
- Electrically height adjustable (40-63cm) battery powered base, 360 degree swivel and lockable. Lithium-ion battery, rechargeable by direct power supply 110/240 VAC 50-60Hz. Available for models Barbizon, Cube, Eldorado, Mania, Open, Sue & Suite.
- Base eléctricamente regulable (40-63cm) en altura mediante batería, giratoria de 360 grados y bloqueable. Batería, con iones de litio, recargable mediante alimentación directa 110/240 VAC 50-60Hz. Disponible para sillas Barbizon, Cube, Eldorado, Mania, Open, Sue y Suite.
- Elektrisch höhenverstellbarer (40-63cm) Standfuß durch Akku, 360 Grad schwenkbar und abschließbar. Batterie mit Lithium-Ionen, wiederaufladbar durch direkte Stromversorgung 110/240 VAC 50-60Hz. Erhältlich für Barbizon, Cube, Eldorado, Mania, Open, Sue und Suite Stühle.

■ Platine fauteuil/piastra/fixing plate/platina/Befestigungsplatte € 29,00

■ Base 5 branches/base stella/cross base/base estrella/Kreuzfuß € 105,00

■ Base ronde/rotonda/round base/redonda/Tellerfuß € 245,00

■ Base carrée/quadrata/square base/cuadrada/Viereckigfuß € 268,00

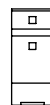
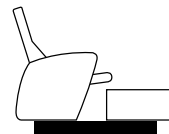
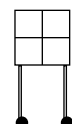
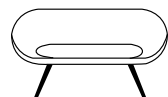
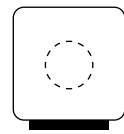
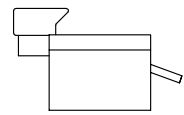
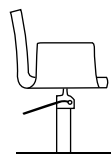
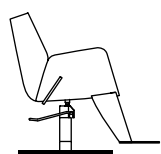
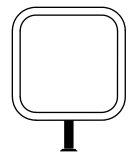

04

BACS DE LAVAGE

LAVAGGI

WASHUNITS

LAVACABEZAS

WASCHESSEL



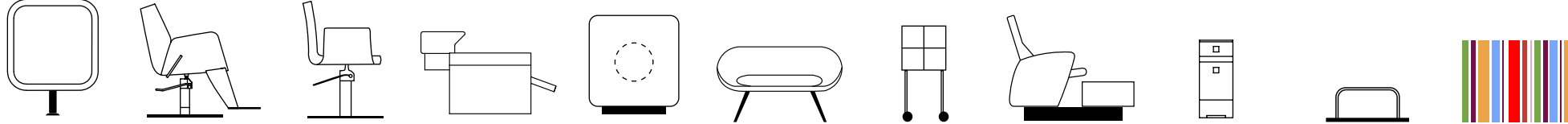

PRIVATUS



PRIVATUS ELECTRIC 1P
FA 550 1P € 5.208,00

PRIVATUS ELECTRIC 2P
FA 550 2P € 9.839,00

PRIVATUS ELECTRIC 3P
FA 550 3P € 14.459,00

SUPPLEMENT SHIATSU AIR / PL € 1.134,00

- Bac de lavage avec cuvette carrée ergonomique basculante (mitigeur et douchette inclus), bonde siphonée et fauteuil intégré. Matelas avec réglage électrique synchronisé du dossier, de l'assise et du repose-jambes pour une position allongée.
- Lavaggio 1/2/3 posti con fiancate "PRIVACY", vasca bianca ergonomica e basculante. Seduta con sistema schienale e poggiatesta a movimento elettrico sincronizzato.
- 1,2 or 3 seater wash unit with highly ergonomic tilting and depth adjustable, white or black, ceramic bowl (mixing tap and hand shower included), waste trap and integrated seat. Mattress with synchronised, remote control adjustment of the backrest, seat and leg rest for a fully reclining position. Available with optional Shiatsu, air, massage.
- Lavabo con lavabo cuadrado ergonómico basculante (mezclador y ducha de mano incluidos), desagüe sifoidea y sillón integrado. Colchón con regulación eléctrica sincronizada del respaldo, asiento y reposapiernas para la posición acostada.
- 1,2 oder 3 Sitzler-Wascheinheit mit hochergonomischer Neigung und Tiefenverstellung, weiß oder schwarz, Keramikschale (Mischhahn und Handbrause inklusive), Abfallfalle und integriertem Sitz. Matratze mit synchronisierter, ferngesteuerter Einstellung der Rückenlehne, des Sitzes und der Beinstütze für eine vollständig liegende Position. Erhältlich mit optionalem Shiatsu, Luft, Massage.

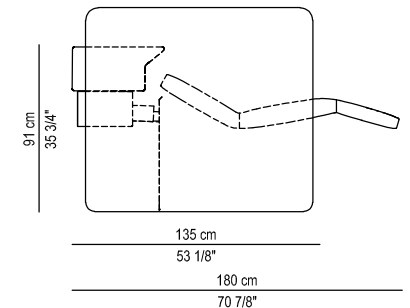
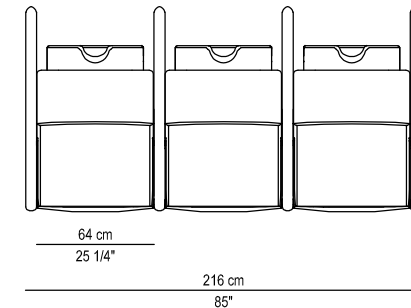
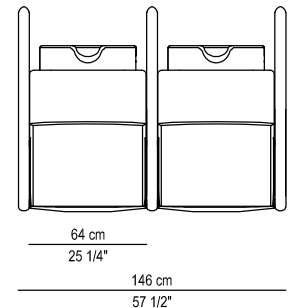
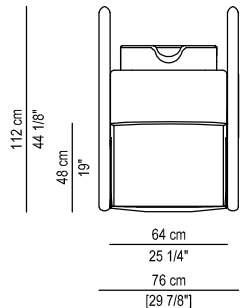

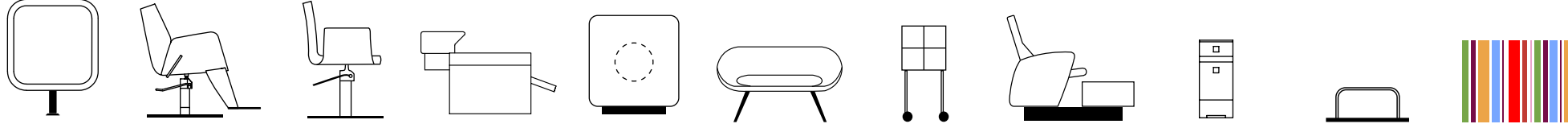

PRIVÉ



PRIVÉ ELECTRIC 1P

FA 390 1P E

€ 5.208,00

PRIVÉ ELECTRIC 2P

FA 390 2P E

€ 9.839,00

PRIVÉ ELECTRIC 3P

FA 390 3P E

€ 14.459,00

- Bac de lavage avec cuvette carrée ergonomique basculante et coulissante (mitigeur et douchette inclus), bonde siphonide et fauteuil intégré. Matelas avec réglage électrique synchronisé du dossier, de l'assise et du repose-jambes pour une position allongée.
- Lavaggio con vasca ergonomica basculante e scorrevole con sistema schienale e poggiatesta a movimento elettrico sincronizzato, posizione allungata.
- Wash unit with ergonomic tilting and sliding square bowl (mixing tap and hand shower included), waste trap valve and integrated seat. Mattress with synchronised electrical adjustment of the backrest, seat and leg rest in a reclining position.
- Lavacabezas con sillón integrado. Cubeta cuadrada ergonómica basculante y corredora (monomando y ducha incluidos) y válvula sifónica. Colchón con ajuste eléctrico sincronizado del respaldo, del asiento y del apoyapiernas. Posición acostada.
- Waschsessel mit ergonomischem rückschwenkem und verschiebbarem viereckigem Becken (Mischbatterie und Handbrause inbegriffen), Ablaufventile mit Geruchstopper und integriertem – Sessel. Sitzfläche mit synchronisierter elektrischer Regelung der Rücklehne, Sessel und Beinauflage für eine liegende Position.

SUPPLEMENT SHIATSU AIR / PL

€ 1.134,00

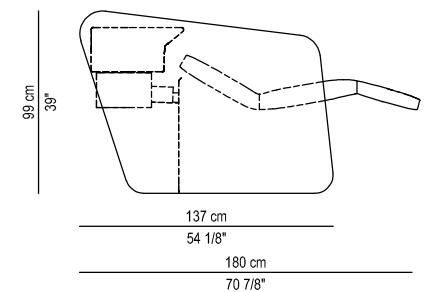
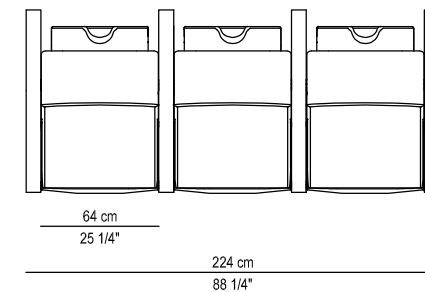
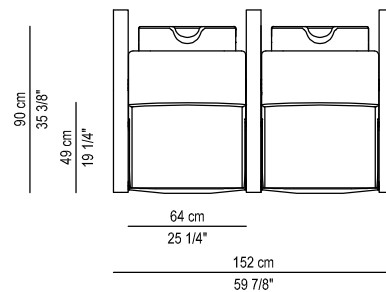
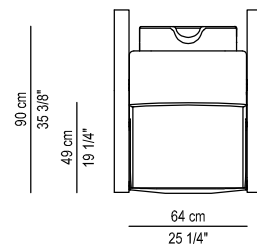

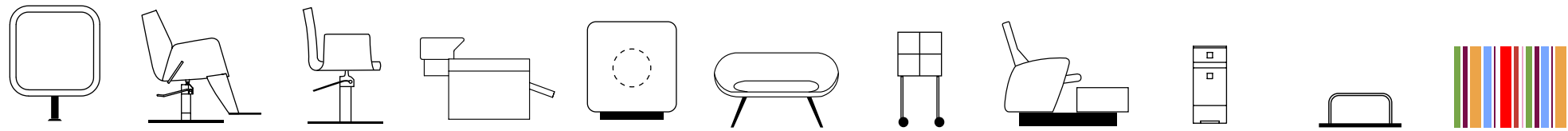

GOWASH

AIR MASSAGE



GOWASH 1P

€ 2.363,00

FA 370 1P

- Bac de lavage avec cuvette ergonomique basculante (mitigeur et douchette inclus), bonde siphonée et fauteuil intégré.
- Lavaggio con vasca ergonomica basculante e sifone, poltrona integrata. Vano posteriore integrato.
- Wash unit with ergonomic tilting bowl and waste trap valve. Integrated seat.
- Lavacabezas con sillón integrado. Cubeta ergonómica basculante (monomando y ducha incluidos) y válvula sifónica.
- Waschsessel mit integriertem Sessel. Ergonomisches und verstellbares Becken. Ablaufventile mit Geruchstopper.

GOWASH ELECTRIC

€ 2.993,00

FA 370 E 1P

- Gowash Basic + Réglage électrique du repose-jambes.
- Gowash Basic + Poggiagambe a movimento elettrico.
- Gowash Basic + Electrical legrest.
- Gowash Basic + Ajuste eléctrico del apoyapiernas.
- Gowash Basic + Mit elektrischer Beinauflage.

GOWASH ELECTRIC + SHIATSU AIR

€ 3.644,00

FA 370 S 1P

- Gowash Basic + Système de massage à air Shiatsu.
- Gowash Basic + Massaggio AIR SHIATSU con due programmi e regolatore di intensità su tutta la poltrona.
- Gowash Basic + Shiatsu Air Massage: air bags inside the seat.
- Gowash Basic + Sistema de masaje integral por aire Shiatsu.
- Gowash Basic + Shiatsu Luftdruckmassage: Luftkissen im Sitz .

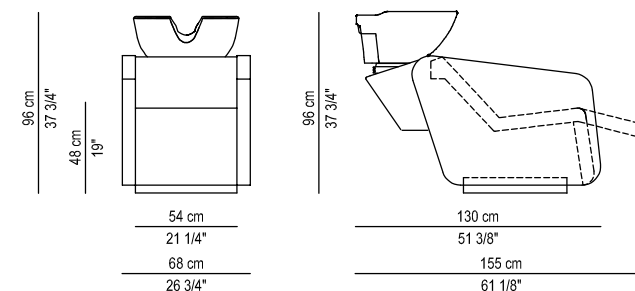

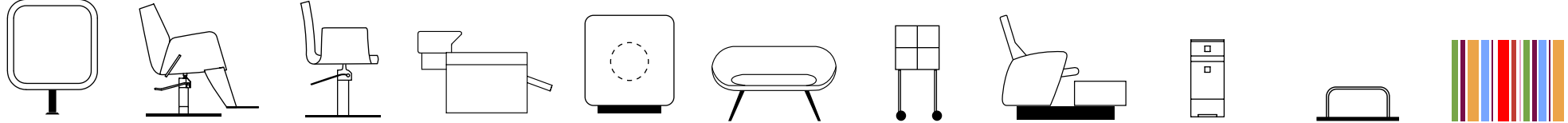

GOWASH

AIR MASSAGE



GOWASH 2P

FA 370 2P

€ 4.725,00

- Bac de lavage avec cuvette ergonomique basculante (mitigeur et douchette inclus), bonde siphonée et fauteuil intégré.
- Lavaggio con vasca ergonomica basculante e sifone, poltrona integrata. Vano posteriore integrato.
- Wash unit with ergonomic tilting bowl and waste trap valve. Integrated seat.
- Lavacabezas con sillón integrado. Cubeta ergonómica basculante (monomando y ducha incluidos) y válvula sifónica.
- Waschsessel mit integriertem Sessel. Ergonomisches und verstellbares Becken. Ablaufventile mit Geruchstopper.

GOWASH 3P

FA 370 3P

€ 7.088,00



SUPPLEMENT ELECTRIC / PL

SUP RJ ELEC

€ 630,00

SUPPLEMENT ELECTRIC + SHIATSU AIR / PL

SUP SHIATSU

€ 1.281,00

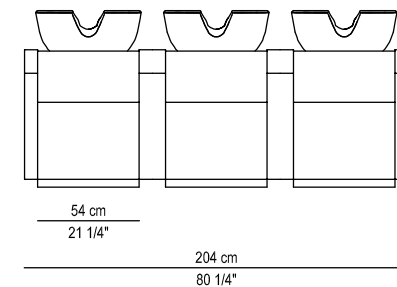
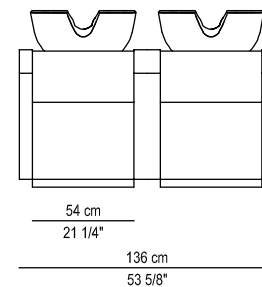

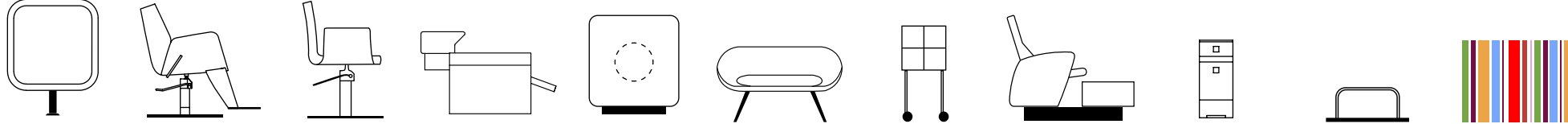

ERGOWASH®

AIR MASSAGE



ERGOWASH® LIFT ELECTRIC

€ 5.103,00

FA200 E

- Bac de lavage avec cuvette ergonomique basculante (mitigeur et douchette inclus), grille anti-cheveux, et fauteuil intégré. Réglage électrique en hauteur de l'ensemble du bac de lavage (cuvette + fauteuil) : ajustable à la taille du coiffeur. Réglage électrique du repose-jambes.
- Lavaggio ergonomico con seduta integrata. Regolazione elettrica in altezza simultanea di vasca e seduta per il maggior confort dell'operatore. Poggiagambe con movimento elettrico.
- Wash unit with ergonomic tilting bowl and waste trap. Electrical height adjustment of complete backwash (seat + basin): adjustable to the size of the hairdresser. With electric leg rest.
- Lavacabezas con sillón integrado. Cubeta ergonómica basculante (monomando y ducha incluidos), regilla antipelo. Arreglo eléctrico de la altura del lavacabezas por completo (cubeta + sillón) :ajustable a la altura del peluquero. Ajuste eléctrico del apoyapiernas.
- Waschsessel 1 Platz mit ergonomischem und verstellbarem Becken und Ablaufventile mit Geruchstopper. Elektrische Höheneinstellung des gesamten Waschsessels (Becken + Sessel) : anpassbar an die Größe des Friseurs. Elektrische Beinauflage; mit Fernbedienung gesteuert.

€ 6.153,00

ERGOWASH® LIFT SHIATSU AIR

FA200 S

- Ergowash® Lift Electric + Système de massage à air Shiatsu.
- Ergowash® Lift Electric + Massaggio AIR SHIATSU con due programmi e regolatore di intensità su tutta la poltrona.
- Ergowash® Lift Electric + Shiatsu Air Massage: air bags inside the seat.
- Ergowash® Lift Electric + Sistema de masaje integral por aire Shiatsu.
- Ergowash® Lift Electric + Shiatsu Luftdruckmassage: Luftkissen im Sitz .

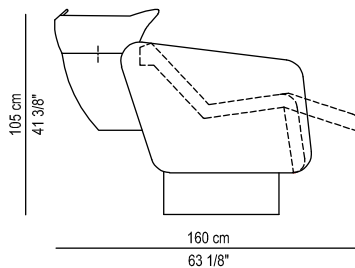
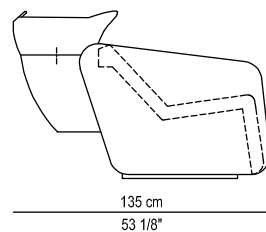
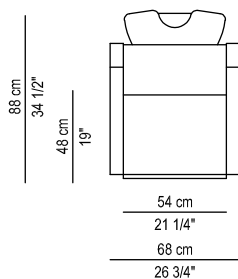

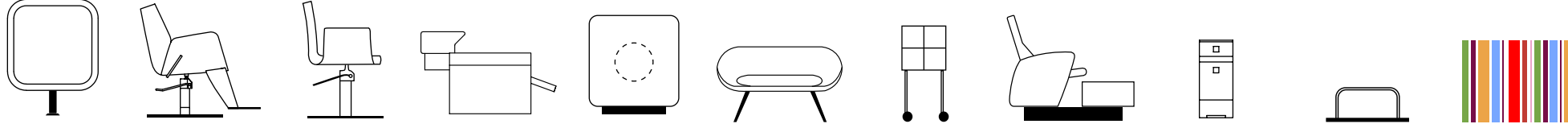

CHROMOWASH



CHROMOWASH ELECTRIC

€ 7.035,00

FA210 E

- Bac de lavage 1 place avec cuvette carrée ergonomique basculante (mitigeur et douchette inclus) et bonde siphonée. Système RGB de chromothérapie : arceau de lumière à séquence polychromes RVB. Réglage électrique synchronisé du dossier, de l'assise et du repose-jambes. Position allongée.
- Lavaggio con vasca quadrata basculante. Sistema ad arco di luce Led con sequenza colori RGB. con sistema schienale e poggiatesta a movimento elettrico sincronizzato, posizione allungata.
- Wash unit with ergonomic tilting square bowl and waste trap. Dynamic LED RGB chromatherapy visor. Synchronized movement of complete seat and leg rest. Reclining position.
- Lavacabezas con sillón integrado. Cubeta cuadrada ergonómica basculante (monomando y ducha incluidos), y válvula sifónica. Sistema RGB (Rojo Verde Azul) de cromoterapia: arco con secuencias de luces multicolores. Ajuste eléctrico sincronizado del respaldo, del asiento y del apoyapiernas. Posición acostada.
- Waschsessel 1 platz mit ergonomischem und verstellbarem Becken und Ablaufventile mit Geruchstopper. LED RGB Beleuchtungssystem : Licht- und Farbtherapie. Synchronisierter elektrischer Rückenlehne. Sitz und Beinstütze. Liegeposition.

CHROMOWASH SHIATSU AIR

€ 8.190,00

FA210 S

- Chromowash Electric + Système de massage à Air Shiatsu.
- Chromowash Electric + Massaggio Air Shiatsu con due programmi e regolatore di intensità su tutta la poltrona.
- Chromowash Electric + Shiatsu Air Massage: air bags inside the seat.
- Chromowash Electric + Sistema de masaje integral por aire Shiatsu.
- Chromowash Electric + Shiatsu Luftdruckmassage: Luftkissen im Sitz.

LA THÉRAPIE NATURELLE PAR LE COULEURS POUR SOULAGER VOS DOULEURS.
 LA TERAPIA NATURALE DEL COLORE PER ALLEVIARE IL DOLORE.
 THE NATURAL THERAPY THROUGH COLOURS TO RELIEVE PAINS.
 LA TERAPIA NATURAL POR LOS COLORES PARA ALIVIAR SUS DOLORES.
 DIE NATURKICHE THERAPIE DURCH FARBEN UM DEN SCHMERZEN ZU LINDERN.

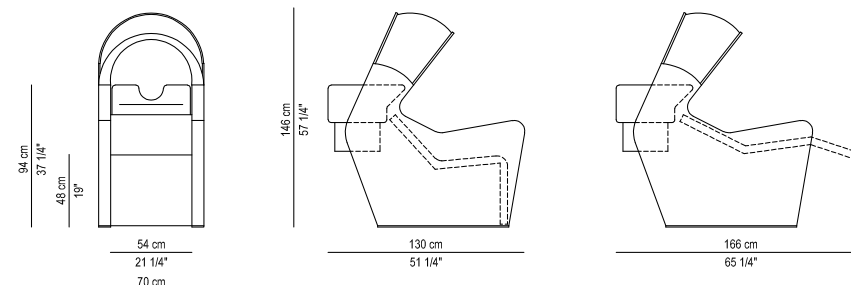

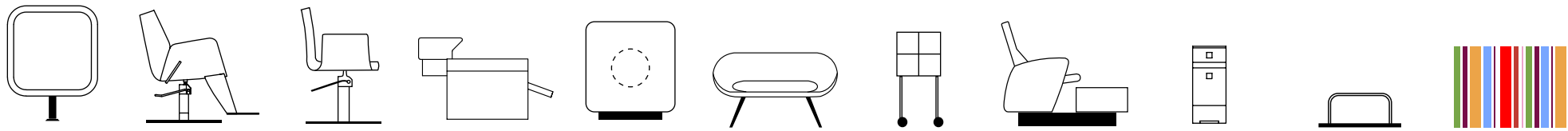

CHARMEWASH

AIR MASSAGE



CHARMEWASH ELECTRIC

€ 3.192,00

FA230 E 1P

- Bac de lavage avec cuvette (mitigeur et douchette compris) ergonomique basculante, bonde siphonée et fauteuil intégré. Réglage électrique du repose-jambes.
- Lavaggio 1 posto con vasca ergonomica basculante, sifone e poltrona integrata. Finiture in alluminio.
- Wash unit with ergonomic tilting bowl (mixing tap and hand shower included), waste trap valve and integrated seat.
- Lavacabezas individual con cubeta de cerámica (monomando y ducha incluidos) ergonómica basculante, conjunto de evacuación y sillón integrado. Ajuste eléctrico del apoyapiernas.
- Waschsessel mit ergonomischem und verstellbarem Becken (Mischbatterie und Handbrause inkl.), Ablaufventile und integrierter Sessel.

CHARMEWASH SHIATSU AIR

€ 3.843,00

FA230 S 1P

- Charmewash Electric + Système de massage à Air Shiatsu.
- Charmewash Electric + Massaggio Air Shiatsu con due programmi e regolatore di intensità su tutta la poltrona.
- Charmewash Electric + Shiatsu Air Massage: air bags inside the seat.
- Charmewash Electric + Sistema de masaje integral por aire Shiatsu.
- Charmewash Electric + Shiatsu Luftdruckmassage: Luftkissen im Sitz.

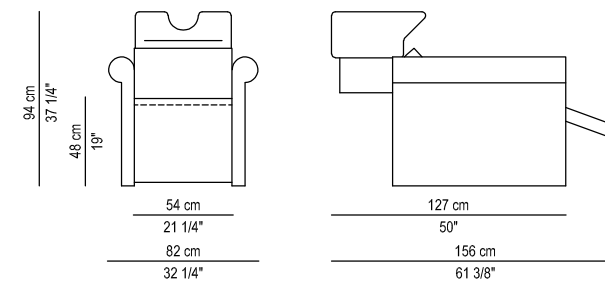

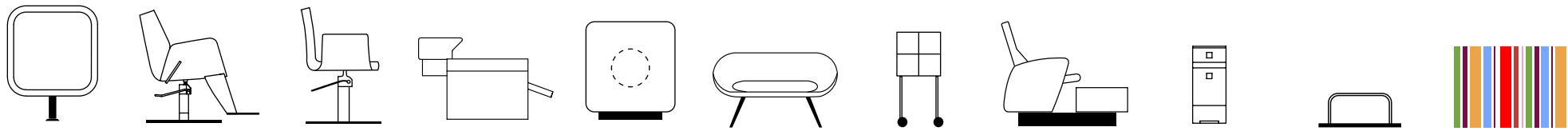

TOPWASH CHROME AIR MASSAGE

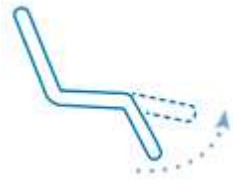

TOPWASH CHROME

FA 490

€ 2.678,00

- Bac de lavage avec cuvette ergonomique basculante (mitigeur et douchette inclus), bonde siphonoïde et fauteuil intégré. Avec rangement intégré à l'arrière du bac.
- Lavaggio con vasca ergonomica basculante e sifone, poltrona integrata. Vano posteriore integrato.
- Wash unit with ergonomic tilting bowl and waste trap valve. Integrated storage.
- Lavacabezas con sillón integrado. Cubeta ergonómica basculante (monomando y ducha incluidos) y válvula sifónica. Con estante trasero integrado.
- Waschsessel mit integriertem Sessel. Ergonomisches und verstellbares Becken. Ablaufventile mit Geruchstopper. Abfertigung aus Aluminium. Mit Regale.

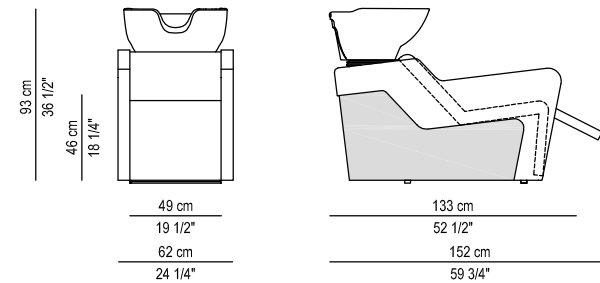

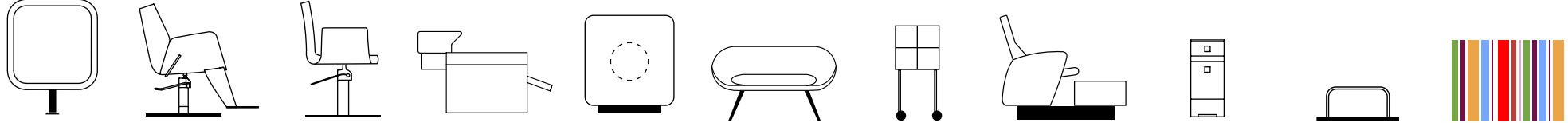

TOPWASH CHROME



TOPWASH CHROME 2P

FA 490 2P

€ 5.355,00



TOPWASH CHROME 3P

FA 490 3P

€ 8.033,00



SUPPLEMENT ELECTRIC / PL

SUP RJ ELEC

€ 630,00

SUPPLEMENT ELECTRIC + SHIATSU AIR / PL

SUP SHIATSU

€ 1.281,00

FERMETURE AU DOS

€ 00

- Tamponamento posteriore
- Back closure
- Cierre trasero
- Rückenverschluss

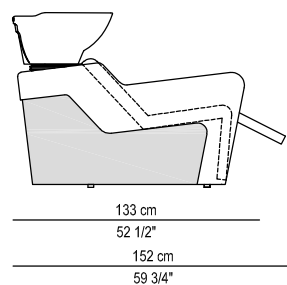
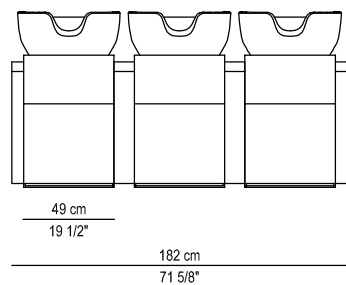
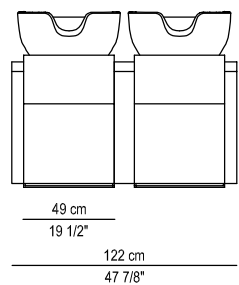

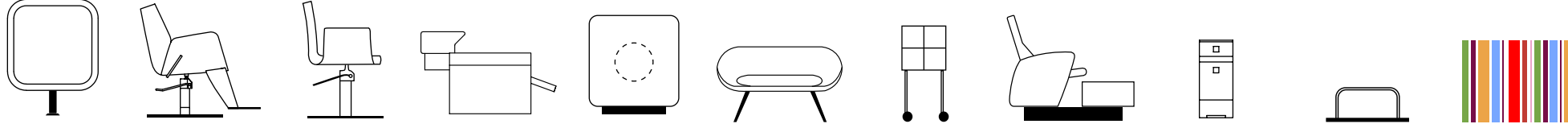

TOPWASH WOOD



TOPWASH WOOD

€ 2.730,00

FA485 1P

- Bac de lavage avec cuvette ergonomique basculante (mitigeur et douchette inclus), bonde siphonoïde et fauteuil intégré. Avec rangement intégré à l'arrière.
- Lavaggio con vasca ergonomica basculante e sifone, poltrona integrata. Vano posteriore integrato.
- Wash unit with ergonomic tilting bowl and waste trap valve. Integrated storage.
- Lavacabezas con sillón integrado. Cubeta ergonómica basculante (monomando y ducha incluidos) y válvula sifónica. Con estante trasero integrado.
- Waschsessel mit integriertem Sessel. Ergonomisches und verstellbares Becken. Ablaufventile mit Geruchstopper. Abfertigung aus Aluminium. Mit Regale.

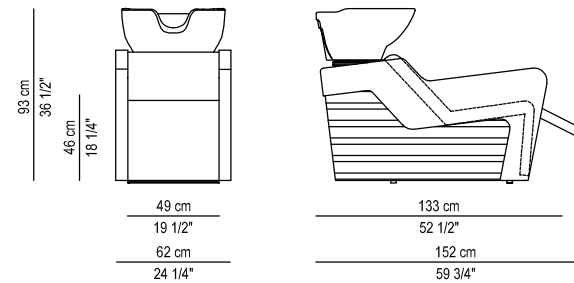

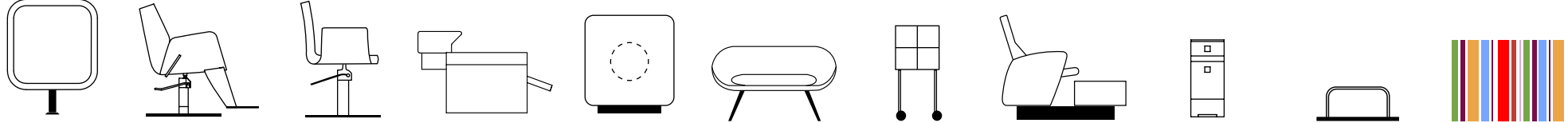

TOPWASH WOOD



TOPWASH WOOD 2P

FA 485 2P

€ 5.460,00



TOPWASH WOOD 3P

FA 485 3P

€ 8.190,00



SUPPLEMENT ELECTRIC / PL

SUP RJ ELEC

€ 630,00

SUPPLEMENT ELECTRIC + SHIATSU AIR / PL

SUP SHIATSU

€ 1.281,00

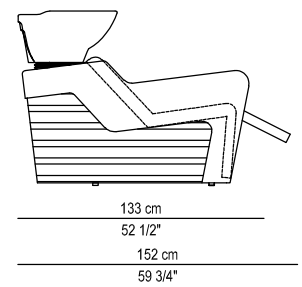
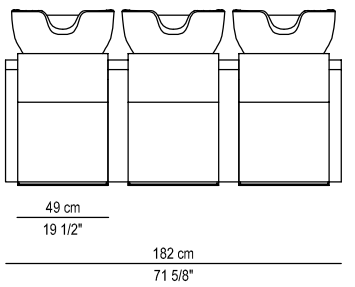
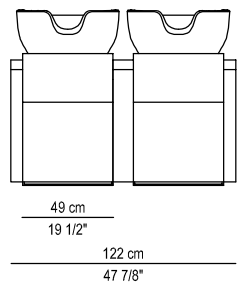

FERMETURE AU DOS

€ 00

- Tamponamento posteriore
- Back closure
- Cierre trasero
- Rückenverschluss



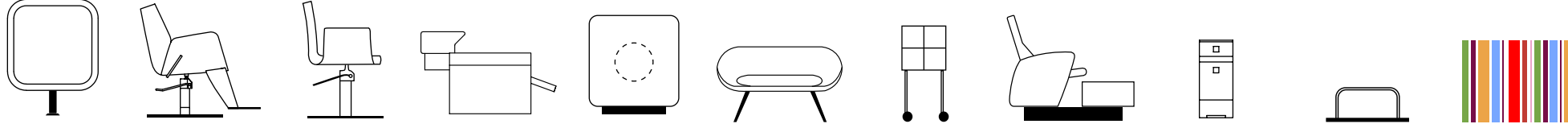

TOPWASH ECO

AIR MASSAGE



TOPWASH ECO

FA495 1P

€ 2.363,00

- Bac de lavage avec cuvette ergonomique basculante (mitigeur et douchette inclus), bonde siphonoïde et fauteuil intégré. Avec rangement intégré à l'arrière.
- Lavaggio con vasca ergonomica basculante e sifone, poltrona integrata. Vano posteriore integrato.
- Wash unit with ergonomic tilting bowl and waste trap valve. Integrated storage.
- Lavacabezas con sillón integrado. Cubeta ergonómica basculante (monomando y ducha incluidos) y válvula sifónica. Con estante trasero integrado.
- Waschsessel mit integriertem Sessel. Ergonomisches und verstellbares Becken. Ablaufventile mit Geruchstopper. Mit Regale.

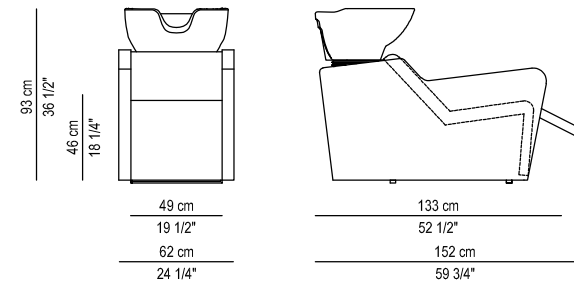

SUPPLEMENT ELECTRIC / PL

SUP RJ ELEC

€ 630,00

SUPPLEMENT ELECTRIC + SHIATSU AIR / PL

SUP SHIATSU

€ 1.281,00

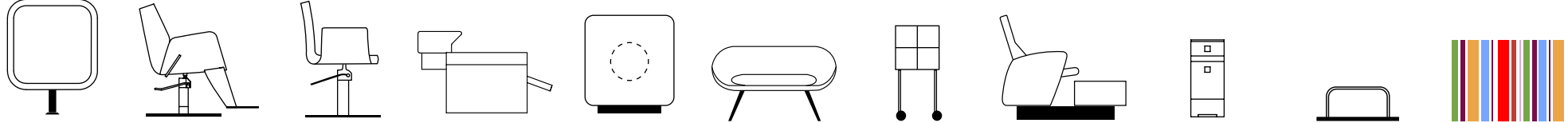

TOPWASH ECO



TOPWASH ECO 2P
FA 495 2P

€ 4.725,00



TOPWASH ECO 3P
FA 495 3P

€ 7.088,00



SUPPLEMENT ELECTRIC / PL
SUP RJ ELEC

€ 630,00

SUPPLEMENT ELECTRIC + SHIATSU AIR / PL
SUP SHIATSU

€ 1.281,00

FERMETURE AU DOS

€ 00

- Tamponamento posteriore
- Back closure
- Cierre trasero
- Rückenverschluss

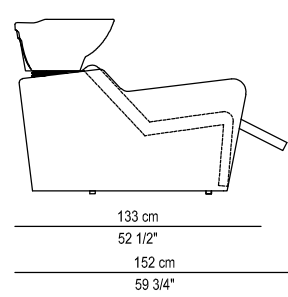
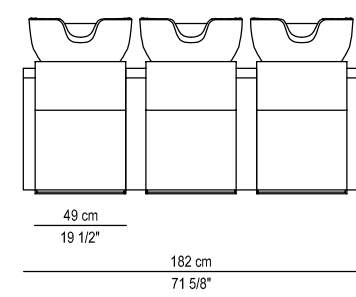
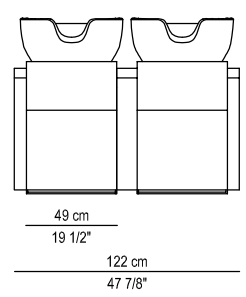

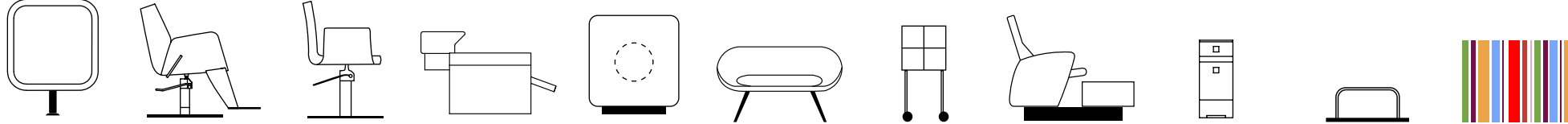

TOPWASH

TOPWASH

FA 480

€ 1.853,00

- Bac de lavage avec cuvette ergonomique basculante, (mitigeur et douchette inclus) bonde siphonée et fauteuil intégré. Sans option.
- Lavaggio con vasca ergonomica basculante, sifone e poltrona integrata.
- Wash unit with integrated seat. Ergonomic tilting bowl and waste trap valve. Option free.
- Lavacabezas con sillón integrado. Cubeta ergonómica basculante (monomando y ducha incluidos) y válvula sifónica. Sin opción.
- Waschsessel mit integriertem Sessel. Ergonomisches und verstellbares Becken. Ablaufventile mit Geruchstopper. Sitz aus Formschaum. Optionfrei.

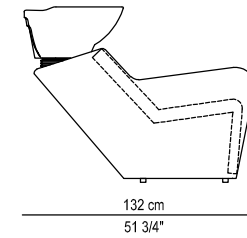
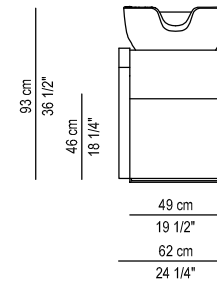

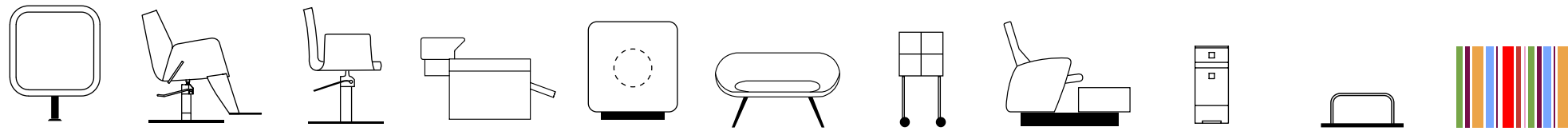

FORMULAWASH



FORMULAWASH ELECTRIC

FA 460 E

€ 3.938,00

- Bac de lavage 1 place avec cuvette carrée ergonomique basculante (mitigeur et douchette inclus), bonde siphonide et fauteuil intégré. Réglage électrique synchronisé du dossier, de l'assise et du repose-jambes. Position allongée.
- Lavaggio fisso con vasca quadrata basculante. Finitura Inox. Schienale e poggiatesta a movimento elettrico sincronizzato. Posizione allungata.
- Wash unit with ergonomic tilting square bowl and waste trap valve. Stainless steel finish. Electrical synchronized movement of the whole seat and the footrest. Lying position.
- Lavacabezas con sillón integrado. Cubeta cuadrada ergonómica basculante (monomando y ducha incluidos), y válvula sifónica. Ajuste eléctrico sincronizado del respaldo, del asiento y del apoyapiernas. Posición acostada.
- Waschsessel mit integriertem Sessel. Ergonomisches und verstellbares Becken. Ablaufventile mit Geruchstopper. Abfertigung aus Edelstahl. Liegeposition.

FORMULAWASH SHIATSU AIR

FA 460 S

€ 4.799,00

- Formulawash Electric + Système de massage à air Shiatsu.
- Formulawash Electric + Schienale e poggiatesta con sistema di massaggio totale Shiatsu.
- Formulawash Electric + With Shiatsu Airmassage from shoulders to feet.
- Formulawash Electric + Sistema de masaje integral por aire Shiatsu.
- Formulawash Electric + Mit kompletter Shiatsu Luftmassage, von Schulter bis Fuß.

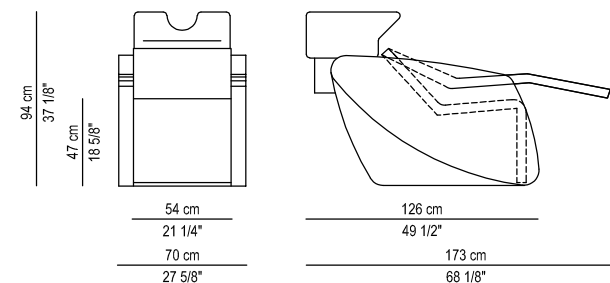

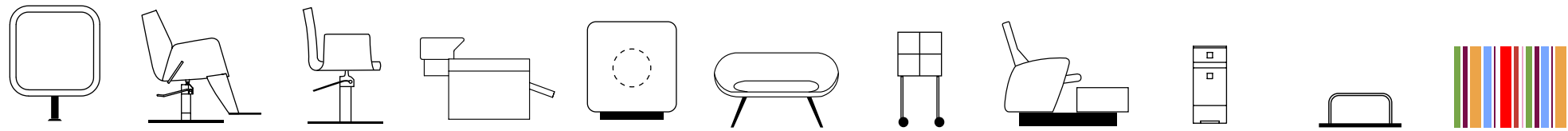

KUAWASH



KUAWASH ELECTRIC

€ 3.938,00

FA 400 E

- Bac de lavage 1 place avec cuvette carrée ergonomique basculante (mitigeur et douchette inclus), bonde siphonide et fauteuil intégré. Réglage électrique synchronisé du dossier, de l'assise et du repose-jambes. Position allongée.
- Lavaggio con vasca quadrata basculante. Finitura Inox sottovasca. con sistema schienale e poggiamambe a movimento elettrico sincronizzato, posizione allungata.
- Wash unit with ergonomic tilting square bowl and waste trap valve. Electrical synchronized movement of the whole seat and the footrest. Lying position.
- Lavacabezas con sillón integrado. Cubeta cuadrada ergonómica basculante (monomando y ducha incluidos), y válvula sifónica. Ajuste eléctrico sincronizado del respaldo, del asiento y del apoyapiernas. Posición acostada.
- Waschsessel 1 platz mit ergonomischem und verstellbarem Becken und Ablaufventile mit Geruchstopper. Synchronisierter elektrischer Rückenlehne, Sitz und Beinstütze. Liegeposition. →

KUAWASH SHIATSU AIR

€ 4.799,00

FA 400 S

- Kuawash Electric + Système de massage à air Shiatsu.
- Kuawash Electric + Schienale e poggiamambe con sistema di massaggio totale Shiatsu.
- Kuawash Electric + With Shiatsu Airmassage from shoulders to feet.
- Kuawash Electric + Sistema de masaje integral por aire Shiatsu.
- Kuawash Electric + Mit kompletter Shiatsu Luftmassage, von Schulter bis Füß.

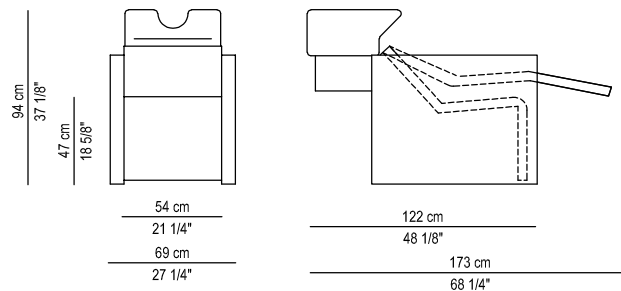

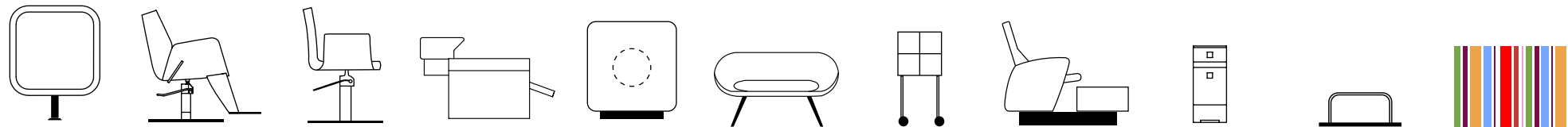

KUAWELL

AIR MASSAGE



KUAWELL BASIC

€ 2.552,00

FA 430

- Bac de lavage avec cuvette carrée ergonomique basculante (mitigeur et douchette inclus), bonde siphonide et fauteuil intégré.
- Lavaggio con vasca ergonomica basculante, sifone e poltrona integrata.
- Wash unit with integrated seat. Ergonomic tilting bowl and waste trap valve.
- Lavacabezas con sillón integrado. Cubeta ergonómica cuadrada basculante (monomando y ducha incluidos) y válvula sifónica.
- Waschsessel mit integriertem Sessel. Ergonomisches und verstellbares Becken. Ablaufventile mit Geruchstopper Abfertigung aus Epoxy Aluminium.

KUAWELL ELECTRIC

€ 3.182,00

FA 450

- Kuawell Basic + Réglage électrique du repose-jambes.
- Kuawell Basic + Poggiagambe a movimento elettrico.
- Kuawell Basic + Electrical legrest.
- Kuawell Basic + Ajuste eléctrico del apoyapiernas.
- Kuawell Basic + Mit elektrischer Beinauflage.

KUAWELL SHIATSU AIR

€ 3.833,00

FA 440

- Kuawell Electric + Système de massage à air Shiatsu.
- Kuawell Electric + Massaggio Air Shiatsu con due programmi e regolatore di intensità su tutta la poltrona.
- Kuawell Electric + Shiatsu Air Massage: air bags inside the seat.
- Kuawell Electric + Sistema de masaje integral por aire Shiatsu.
- Kuawell Electric + Shiatsu Luftdruckmassage : Luftkissen im Sitz.

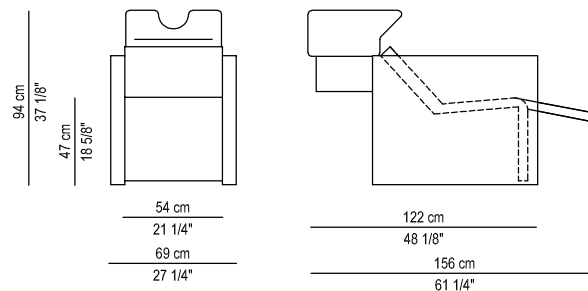

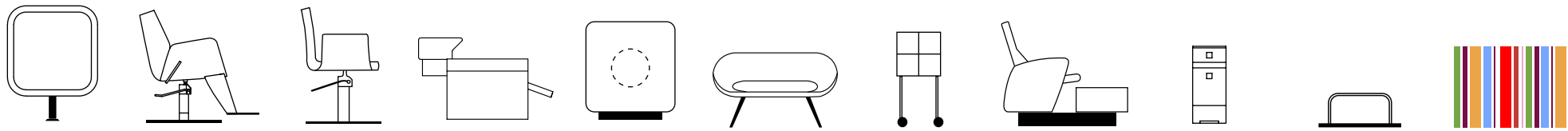

SMARTWASH



SMARTWASH BASIC

€ 2.552,00

FA 260

- Bac de lavage avec cuvette carrée ergonomique basculante (mitigeur et douchette inclus), bonde siphonide et fauteuil intégré.
- Lavaggio con vasca ergonomica basculante, sifone e poltrona integrata.
- Wash unit with integrated seat. Ergonomic tilting bowl and waste trap valve.
- Lavacabezas con sillón integrado. Cubeta cuadrada ergonómica basculante (monomando y ducha incluidos) y válvula sifónica.
- Waschsessel mit integriertem Sessel. Ergonomisches und verstellbares Becken. Ablaufventile mit Geruchstopper Abfertigung aus Epoxy Aluminium.

SMARTWASH ELECTRIC

€ 3.182,00

FA 270

- Smartwash Basic + Réglage électrique du repose-jambes.
- Smartwash Basic + Poggiagambe a movimento elettrico.
- Smartwash Basic + Electrical legrest.
- Smartwash Basic + Ajuste eléctrico del apoyapiernas.
- Smartwash Basic + Mit elektrischen Beinauflage.

SMARTWASH SHIATSU AIR

€ 3.833,00

FA 280

- Smartwash Electric + Système de massage à air Shiatsu.
- Smartwash Electric + Massaggio Air Shiatsu con due programmi e regolatore di intensità su tutta la poltrona.
- Smartwash Electric + Shiatsu Air Massage: air bags inside the seat.
- Smartwash Electric + Sistema de masaje integral por aire Shiatsu.
- Smartwash Electric + Shiatsu Luftdruckmassage: Luftkissen im Sitz.

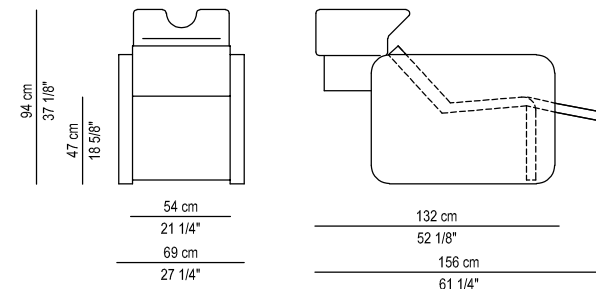

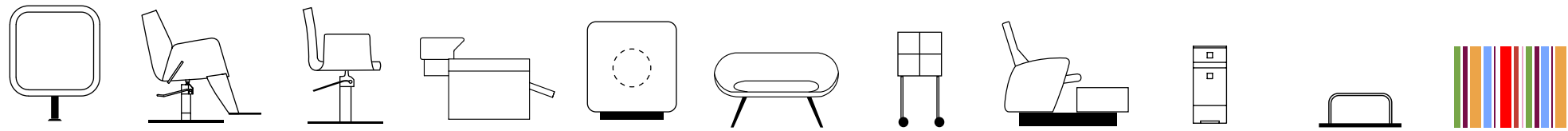

SOFA PLUS

AIR MASSAGE



SOFA PLUS 2P

FA 350 2

€ 5.303,00

- Bac de lavage avec caisson de rangement arrière intégré. Caisson blanc en menuiserie hydrofuge avec partie supérieure en aluminium gris uniquement. Cuvette carrée ergonomique basculante (mitigeur et douchette inclus), et bonde siphonide. Banquette de 2 ou 3 places.
- Lavaggio con vasca basculante. Struttura impermeabile con parte superiore in alluminio. Vasca ergonomica profonda e sifone. Poltrona separata 2 o 3 posti.
- Wash unit with integrated rear storage unit. Structure in water repellent laminate with the upper part in aluminium grey only. Ergonomic tilting bowl and waste trap. 2 or 3 places.
- Lavacabezas con mueble trasero integrado. Estructura blanca de carpintería tratada especialmente contra agua con parte superior de aluminio gris solamente. Cubeta cuadrada profunda ergonómica basculante (monomando y ducha incluidos) y válvula sifónica. 2 o 3 servicios.
- Waschsessel mit integriertem Raumrückelement. Struktur aus Wasserabweisendem Laminat mit Oberteilen nur aus grauem Aluminium. Ergonomisches und verstellbares Becken. Ablaufventile mit Geruchstopper. 2 oder 3 Plätze.

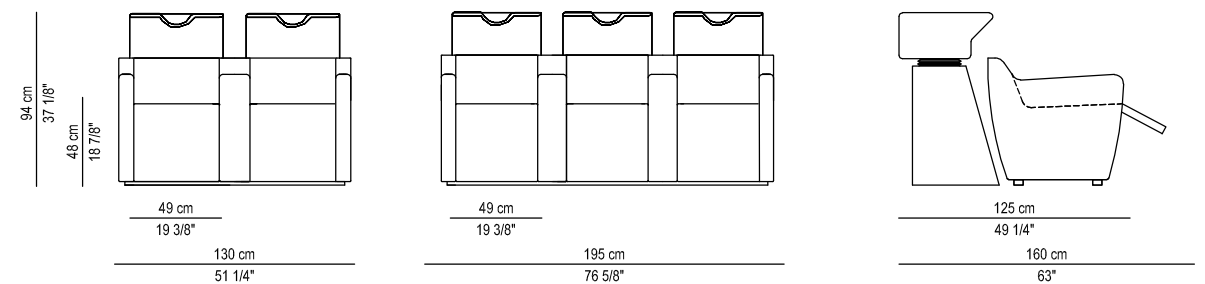

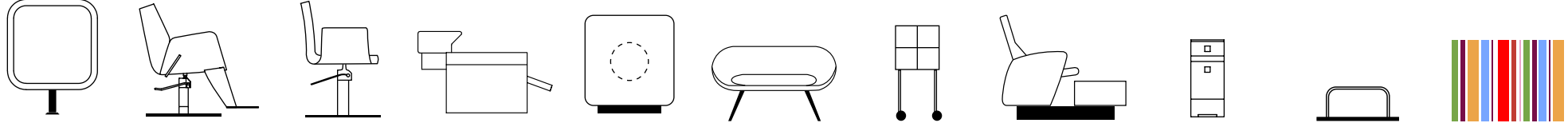

SOFA PLUS

AIR MASSAGE



SOFA PLUS 3P

FA 350 3

€ 7.955,00

SUPPLEMENT ELECTRIC / PL

SUP RJ ELEC

€ 630,00

SUPPLEMENT ELECTRIC + SHIATSU AIR / PL

SUP SHIATSU

€ 1.281,00

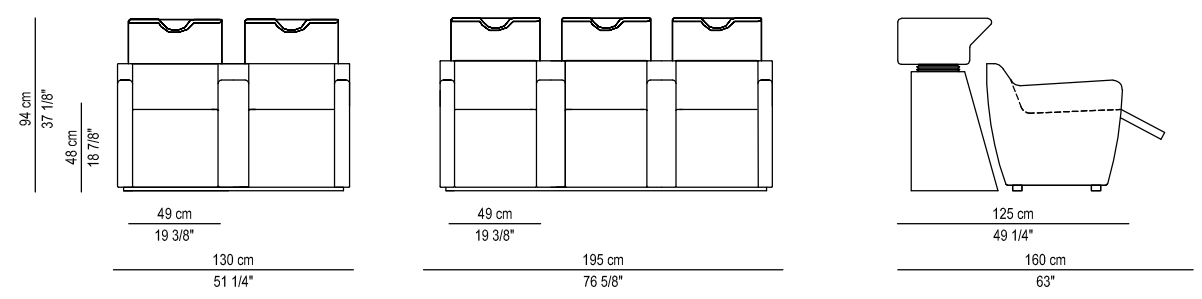

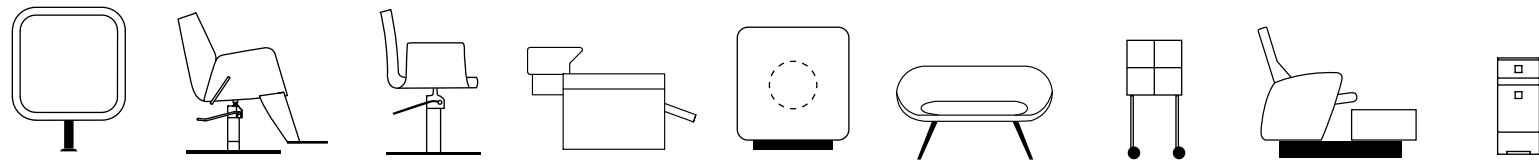

ARMOR SUP

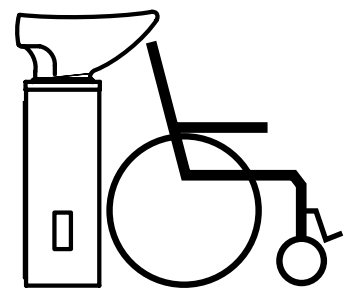

ARMOR SUP

FA 1910

€ 1.145,00

- Colonne de lavage en aluminium. Cuvette profonde ergonomique réglable.
- Colonna lavaggio in alluminio verniciato. Vasca ergonomica, sistema basculante.
- Washpoint in Epoxy Aluminium with tilting bowl.
- Columna de lavado de aluminio. Cubeta profunda ergonómica, basculante.
- Waschsäule aus Aluminium. Verstellbares Becken.

ARMOR LIFT

FA 1920

€ 2.090,00

- Colonne de lavage en aluminium. Cuvette profonde ergonomique réglable. Réglage de la hauteur avec pompe hydraulique.
- Colonna lavaggio in alluminio verniciato. Vasca ergonomica, sistema basculante. Regolazione in altezza con pompa idraulica.
- Washpoint in aluminium with ergonomic tilting bowl. Adjustment of the height with hydraulic pump.
- Columna de lavado de aluminio. Cubeta profunda, ergonómica y basculante. Ajuste de altura con bomba hidraulica.
- Waschsäule aus Aluminium mit verstellbarem Becken. Höheinstellung mit hydraulischer Pumpe.

ARMOR LIFT

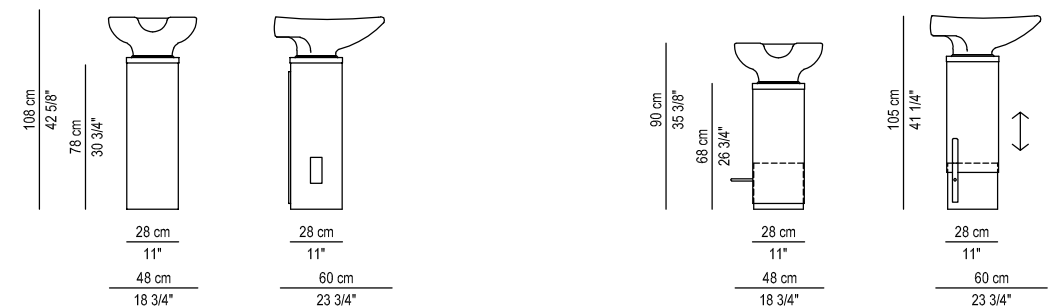

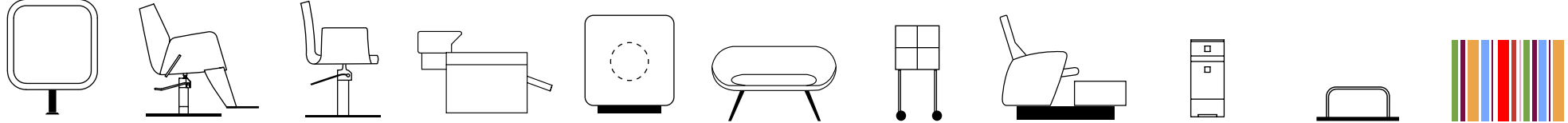

05

A C C U E I L
R E C E P T I O N S
D E S K S
R E C E P C I O N E S
T H E K E N



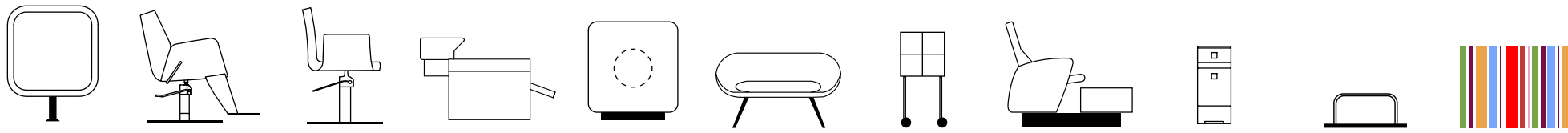

CICERO

CICERO

FH 330

2.898,00 €

- Caisse en mélaminé Noir mat. Façade en cercle en noir mat avec chant en laiton.
- Cassa reception in nobilitato nero opaco. Decoro lineare con piatto in ottone lucido. Disco in laminato nero opaco con bordo in pvc ottone lucido.
- Reception desk with matt black melamine structure and front, with lockable drawer and retractable shelf. Front linear decoration plate in polished brass. Disc in matt black laminate with the edge in PVC polished brass finish.
- Estuche de recepción en melamina negra mate. Decoración lineal con placa en latón pulido. Disco en laminado negro mate con borde en PVC de latón pulido.
- Rezeption mit mattschwarzer Melaminstruktur und Vorderseite. Lineare Dekorplatte vorne aus poliertem Messing. Scheibe aus mattschwarzem Laminat mit Kante aus PVC-poliertem Messing.

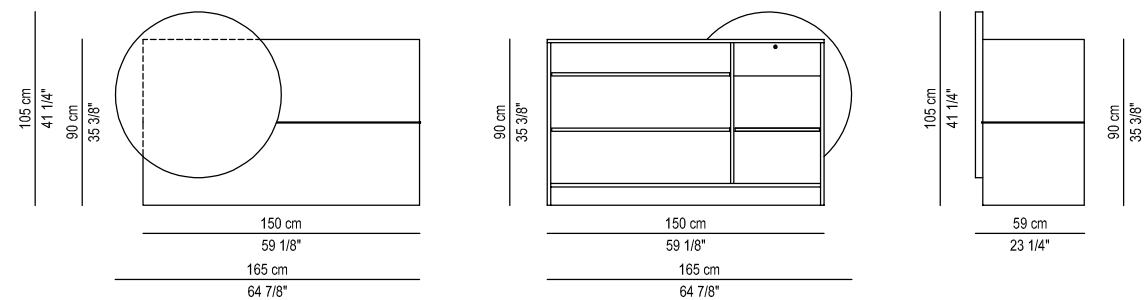

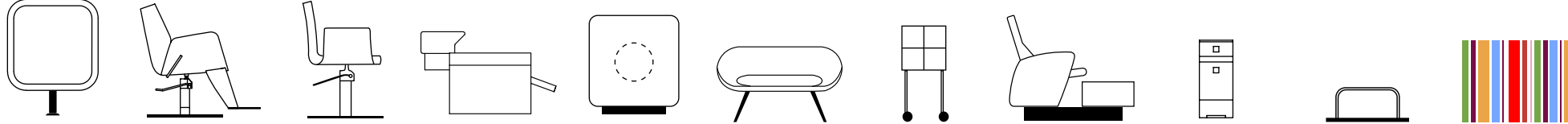

iDESK

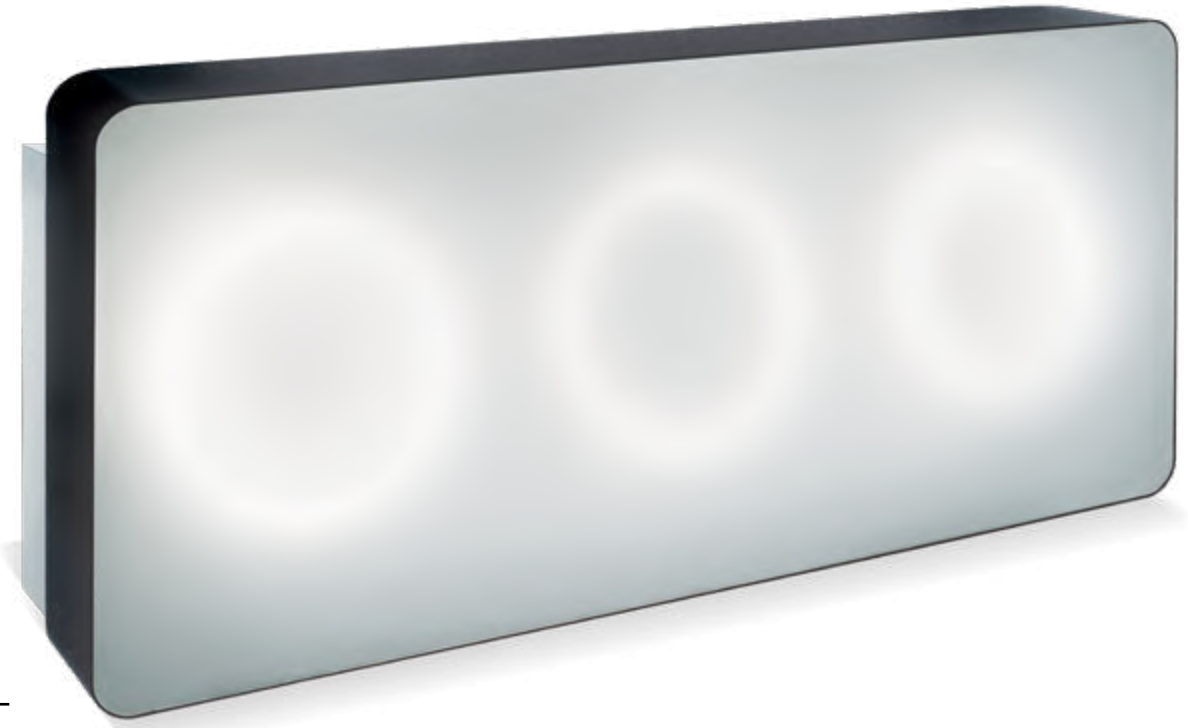

IDESK FH 3000

€ 4.295,00

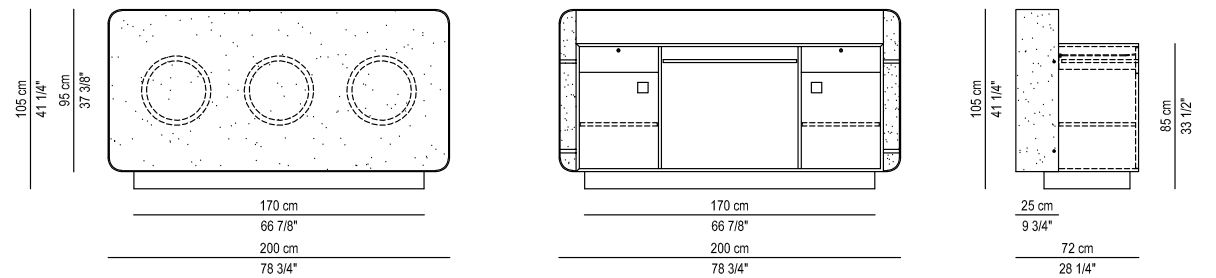

IDESK MEDIUM FH 3100

€ 2.814,00

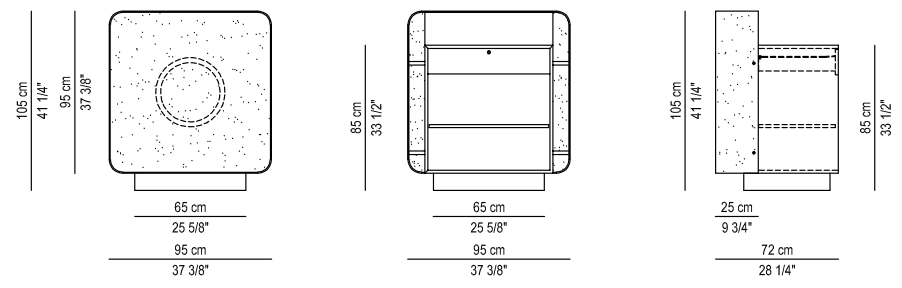

- Caisse en mélaminé Blanc Luxe 31. Partie avant en plexiglas opale éclairé avec cadre noir ou blanc.
- Cassa reception Blanc Luxe 31. Cassonetto frontale in plexiglas opalino completo di illuminazione interna. Cornice perimetrale nero o bianco.
- Reception with laminate structure in Blanc Luxe 31. Backlit plexiglas front section with a black or white plexiglas frame.
- Recepción de melanina Blanc Luxe 31. Parte frontal de metacrilato ópalo iluminado con un marco negro o blanco.
- Theke mit Rückseite aus Laminat Blanc Luxe 31. Vorderseite aus weißem Plexiglas mit Beleuchtung und Rahmen aus schwarzem oder weißem Plexiglas.

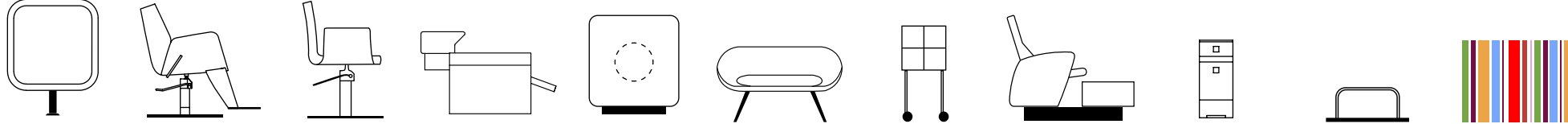

iECO

iECO

FH 1700

€ 1.575,00

- Caisse en mélaminé blanc. Façade en stratifié blanc mat T41, contour Orme-Cannelle T11. Façade tiroir Orme-Cannelle T11.
- Cassa in melaminico colore bianco con bordo in orme cannelle T11. Frontale cassetto in Orme-Cannelle.
- Reception in white laminate Blanc T41 with edging and drawer front in Orme Cannelle T11.
- Recepción de melamina color Blanco mate T41. Parte frontal color blanco T41 y contorno color Orme-Cannelle T11. Fachada del cajón Orme-Cannelle T11.
- Theke in weißem Laminat. Weißer Vorderteil und Seiten Orme-Cannelle T11. Schubladefrontwand in Orme-Cannelle T11.

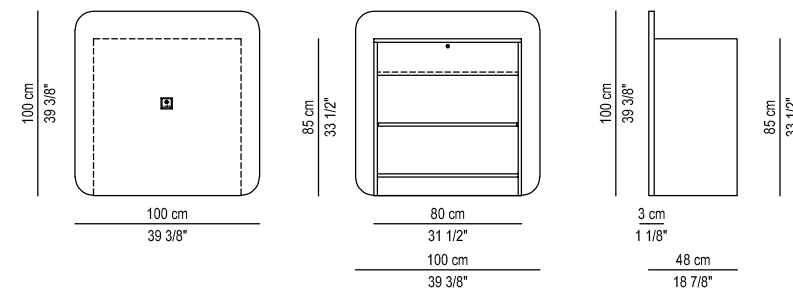

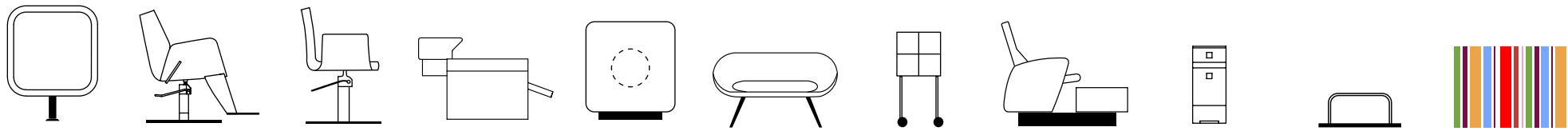

ELITE



ELITE

FH 1010

€ 3.297,00

- Caisse en mélaminé Blanc Luxe 31 et partie avant en plexiglas opale éclairé. Tablette aluminium poli ou blanc laqué.
- Cassa reception in nobilitato Blanc Luxe 31, frontale in plexiglas bianco. Con illuminazione e ripiano in alluminio lucidato o laccato bianco.
- Reception with rear section in laminate Blanc Luxe 31. Front section in white backlit plexiglas with polished or white lacquered aluminium shelf.
- Recepción de melaminado Blanc Luxe 31 y parte delantera de metacrilato ópalo iluminado. Repisa de aluminio pulido o lacado blanco.
- Theke mit Rückseite aus Laminat Blanc Luxe 31. Vorderseite aus weißem Plexiglas mit Beleuchtung und Ablage aus poliertem oder weißlackiertem Aluminium.

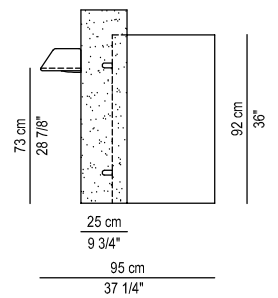
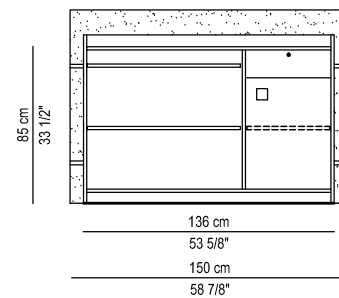
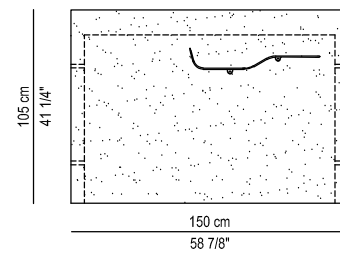

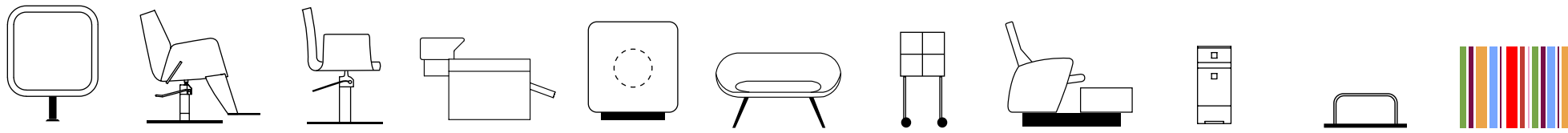

LUMY II



LUMY II MAX

FH 1660

€ 2.279,00

- Caisse en mélaminé Blanc Luxe 31 ou Noir 42. Caisson supérieur en plexiglas blanc éclairé.
- Cassa reception in nobilitato Blanc Luxe 31 o Nero 42. Frontale in plexiglas opalino completo di illuminazione interna.
- Reception desk in laminate Blanc Luxe 31 or Noir 42. Top section in white, backlit plexiglass.
- Recepción de melanina Blanc Luxe 31 o Noir 42. Cajón superior de metacrilato blanco iluminado.
- Theke aus Laminat Blanc Luxe 31 oder Noir 42. Vorderseite aus weißem Plexiglas mit Beleuchtung.

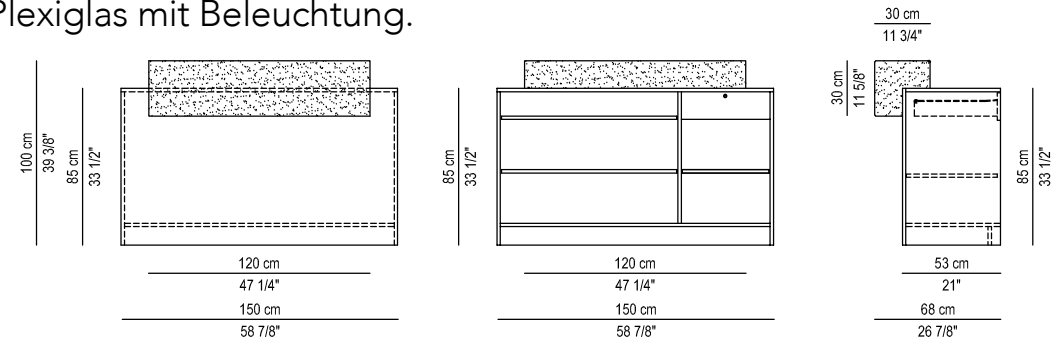

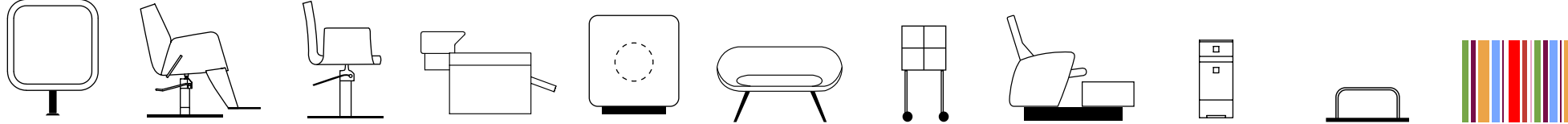

LUMY II



LUMY II MEDIUM

€ 1.712,00

FH 1650

- Caisse en mélaminé Blanc Luxe 31 ou Noir 42. Caisson supérieur en plexiglas blanc éclairé.
- Cassa reception in nobilitato Blanc Luxe 31 o Noir 42. Frontale in plexiglas opalino completo di illuminazione interna.
- Reception desk in laminate Blanc Luxe 31 or Noir 42. Top section in white, backlit plexiglass.
- Recepción de melanina Blanc Luxe 31 o Noir 42. Cajón superior de metacrilato blanco iluminado.
- Theke aus Laminat Blanc Luxe 31 oder Noir 42. Vorderseite aus weißem Plexiglas mit Beleuchtung.

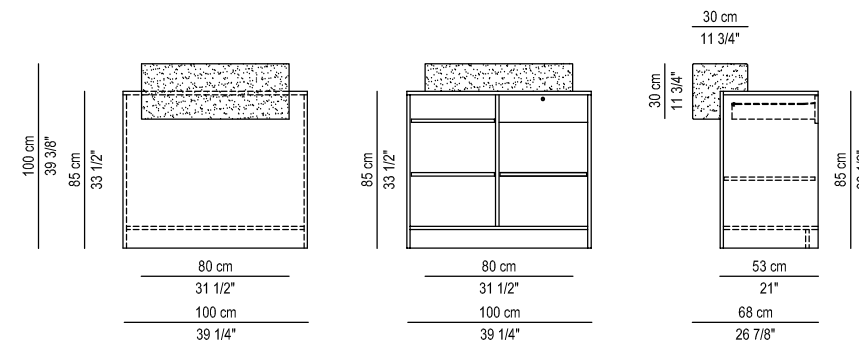

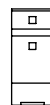
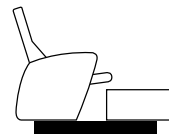
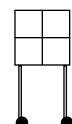
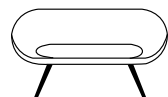
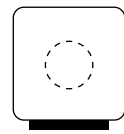
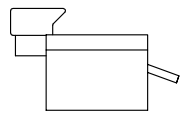
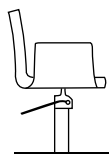
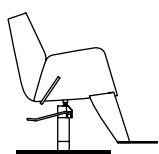
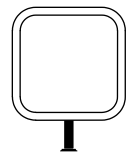

06

CHAUFFEUSES

D I V A N I

RECEPTION SEATING

SILLONES DE ESPERA

WARTESSEL



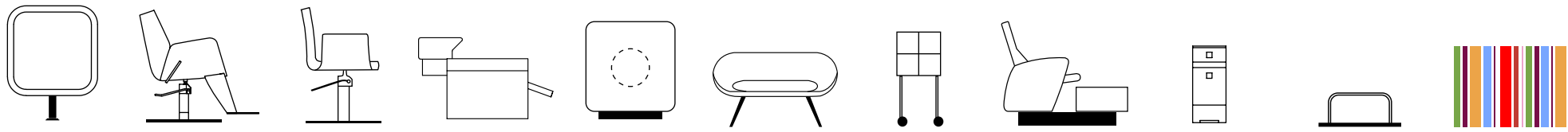

COSTE'S SOFA

COSTE'S SOFA

FD 6500

€ 1.785,00

- Divan 2 places. Skai au choix dans notre gamme.
- Divano 2 posti. Skai a scelta dalla nostra gamma.
- 2 seater waiting chair. Skai from our range.
- Diván 2 plazas. Tapizado a escoger en nuestra gama.
- 2 Sitzplätze Wartesessel. Skay aus unserem Sortiment.



COSTE'S SOFA VELOURS

FD 6600

€ 1.890,00

- Divan 2 places. Velours au choix dans notre gamme.
- Divano 2 posti. Velluto a scelta dalla nostra gamma.
- 2 seater waiting chair. Velvet from our range.
- Diván 2 plazas. Terciopelo a escoger en nuestra gama.
- Wartesessel 2 Sitzplätze. Samt aus unserem Sortiment.

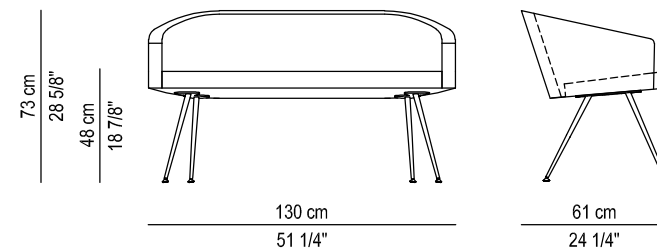

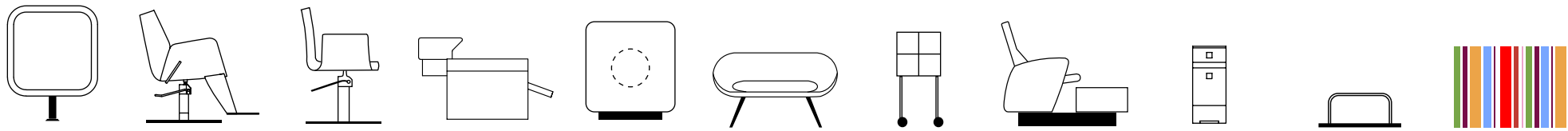

KRYPTON



KRYPTON 1P

FD 4000

€ 609,00

- Chauffeuse d'attente 1 place. Pieds en aluminium poli. Skaï au choix dans notre gamme
- Poltrona attesa 1 posto. Piedi di alluminio lucido. Skai a scelta dalla nostra gamma.
- 1 seat waiting chair with polished aluminium feet. Skay from our range.
- Sillón de espera 1 plaza. Pies de aluminio pulido. Tapizado a escorger en nuestra gama.
- Wartesessel mit 1 Sitzplatz. Füße aus poliertem aluminium. Skay aus unserem Sortiment.

KRYPTON 1P VELOURS

FD 4100

€ 725,00

- Chauffeuse d'attente 1 place. Pieds en aluminium poli. Velours au choix dans notre gamme.
- Poltrona attesa a 1 posto. Piedi di alluminio lucido. Velluto a scelta dalla nostra gamma.
- 1 seat waiting chair with polished aluminium feet. Velvet from our range.
- Sillón de espera 1 plaza . Pies de aluminio pulido. Terciopelo a escorger en nuestra gama.
- Wartesessel mit 1 Sitzplatz. Füße aus poliertem aluminium. Samt aus unserem Sortiment.

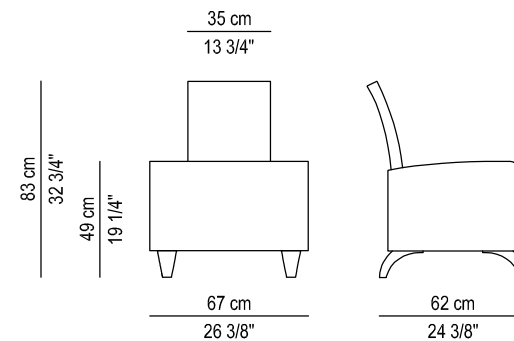

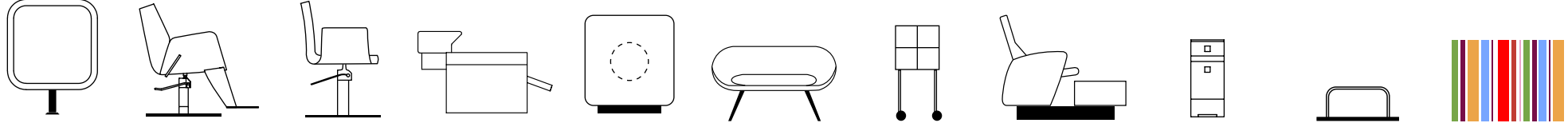

KRYPTON

KRYPTON 2P

FD 4002

€ 1.013,00

KRYPTON 2P VELOURS

FD 4102

€ 1.013,00

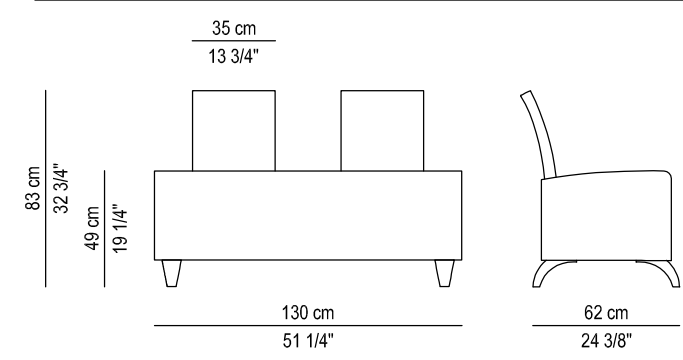

SUPPLEMENT PORTE CASQUE

FD SPCF 4000

€ 175,00

- Porte casque avec supplément. Prix par place.
- Porta casco con supplemento. Prezzo per posto.
- Extra charge for dryer bracket. Price per place.
- Costo adicional por soporte casco secador. Precio por puesto.
- Aufpreis für Haubeträger. Preis pro Platz.

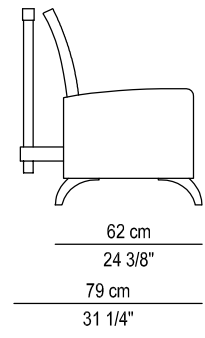

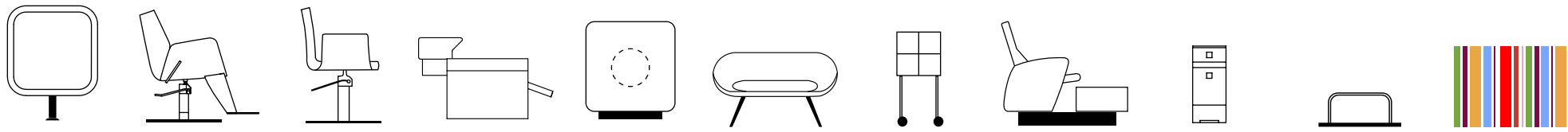

HOMERUS

HOMERUS

€ 1.155,00

FD 200

- Divan 2 places. Skai et Velours aux choix dans notre gamme.
- Divano attesa 2 posti con struttura in metallo finitura nero opaco. Skai e Velluti a scelta dalla nostra gamma.
- 2 seater reception sofa with steel matt black frame available in a selected range of skai or velvet fabrics.
- Sofá de espera de 2 plazas con estructura de metal acabado negro mate. Skai y terciopelos de su elección de nuestra gama.
- 2-Sitzer-Empfangssofa mit mattschwarzem Rahmen, erhältlich in einer ausgewählten Auswahl an Skai-Stoffen. Die Farbauswahl finden Sie unter Materialien unten.

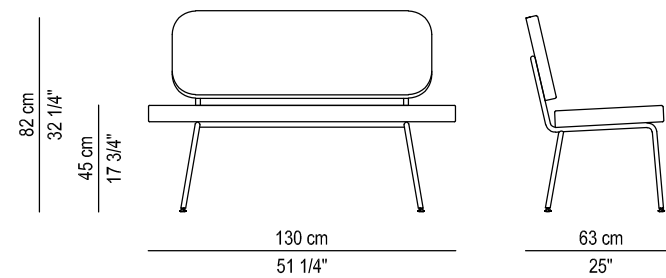

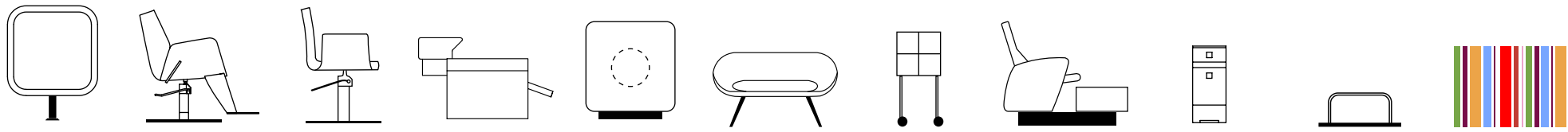

ISLE MAX

ISLE MAX

FD 5200

€ 2.615,00

- Divan 4 ou 5 places. Skai au choix dans notre gamme.
- Divano 4 o 5 posti. Skai a scelta dalla nostra gamma.
- 4 or 5 seater waiting chair. Skay from our range.
- Diván 4 o 5 plazas. Tapizado a escoger en nuestra gama.
- 4 oder 5 Sitzplätze Wartesessel. Skay aus unserem Sortiment.



ISLE MAX VELOURS

FD 5300

€ 2.898,00

- Divan 4 ou 5 places. Velours au choix dans notre gamme.
- Divano 4 o 5 posti. Velluto a scelta dalla nostra gamma.
- 4 or 5 seater waiting chair. Velvet from our range.
- Diván 4 ó 5 plazas. Terciopelo a escoger en nuestra gama.
- 4 oder 5 Sitzplätze Wartesessel. Samt aus unserem Sortiment.

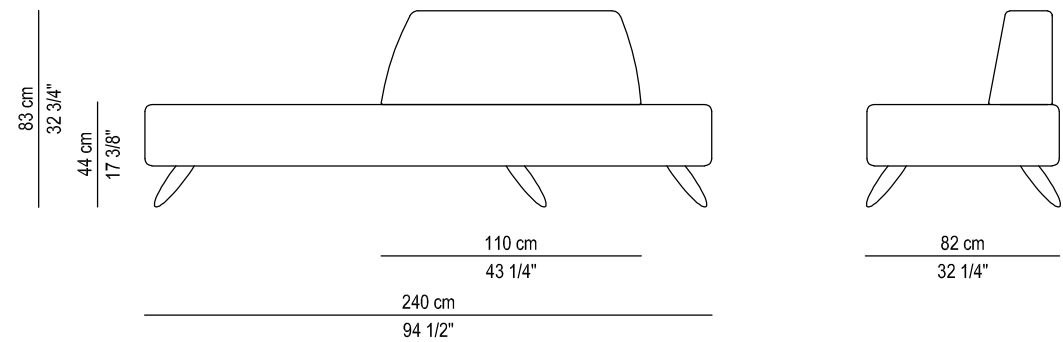

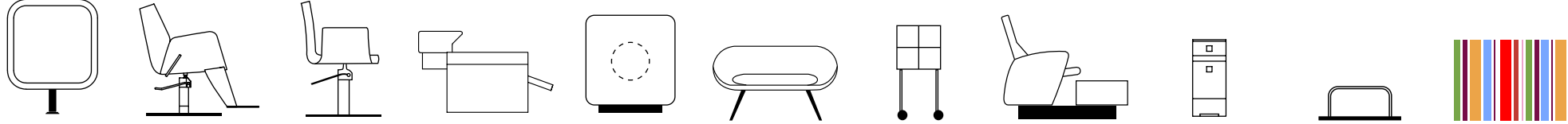

ISLE



ISLE

FD 5000

€ 2.247,00

- Divan 3 ou 4 places. Skaï au choix dans notre gamme.
- Divano 3 o 4 posti. Skai a scelta dalla nostra gamma.
- 3 or 4 seater waiting chair. Skay from our range.
- Diván 3 o 4 plazas. Tapizado a escoger en nuestra gama.
- 3 oder 4 Sitzplätze Wartesessel. Skay aus unserem Sortiment.

ISLE VELOURS

FD 5100

€ 2.247,00

- Divan 3 ou 4 places. Velours au choix dans notre gamme.
- Divano 3 o 4 posti. Velluto a scelta dalla nostra gamma.
- 3 or 4 seater waiting chair. Velvet from our range.
- Diván 3 ó 4 plazas. Terciopelo a escoger en nuestra gama.
- Wartesessel 3 oder 4 sitzplätze. Samt aus unserem Sortiment.

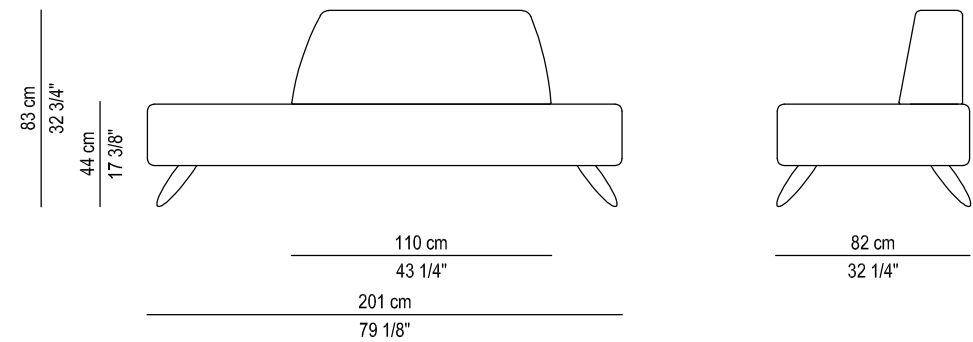

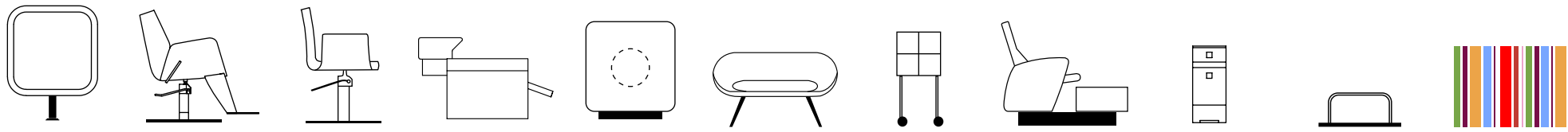

ELITE



ELITE

FD 6000

€ 2.310,00

- Divan 2 places. Skai au choix dans notre gamme.
- Divano 2 posti. Skai a scelta dalla nostra gamma.
- 2 seater waiting chair. Skay from our range.
- Diván 2 plazas. Tapizado a escoger en nuestra gama.
- 2 Sitzplätze Wartesessel. Skay aus unserem Sortiment.

ELITE VELOURS

FD 6100

€ 2.604,00

- Divan 2 places. Velours au choix dans notre gamme.
- Divano 2 posti. Velluto a scelta dalla nostra gamma.
- 2 seater waiting chair. Velvet from our range.
- Diván 2 plazas. Terciopelo a escoger en nuestra gama.
- 2 Sitzplätze Wartesessel. Samt aus unserem Sortiment.

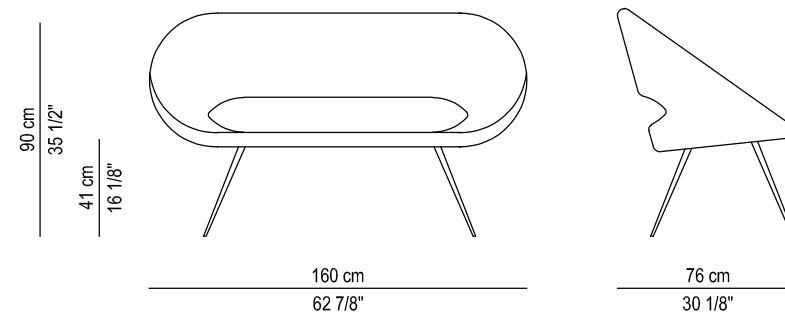

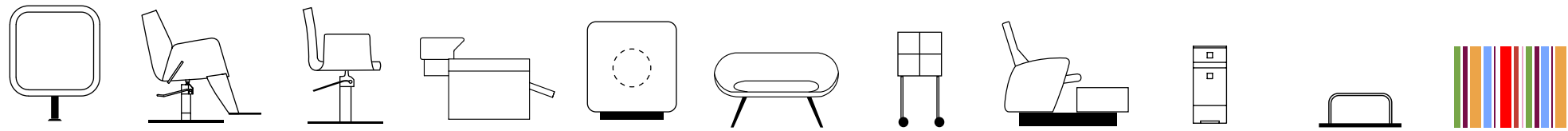

PYRAMID



PYRAMID

FD 3002

€ 1.418,00

- Chauffeuse d'attente 2 places. Pieds en aluminium poli.
- Divano attesa a 2 posti. Piedi di alluminio lucido. Skai a scelta dalla nostra gamma.
- 2 seater waiting chair with polished aluminium feet.
- Sillón de espera 2 plazas. Pies de aluminio pulido. Tapizado a escoger en nuestra gama.
- Wartesessel mit 2 sitzplätze. Füße aus poliertem aluminium.

€ 175,00

SUPPLEMENT PORTE CASQUE

FD SPCF 4000

- Porte casque avec supplément. Prix par place.
- Porta casco con supplemento. Prezzo per posto.
- Extra charge for dryer bracket. Price per place.
- Costo adicional por soporte casco secador. Precio por puesto.
- Aufpreis für Haubeträger. Preis pro Platz.

- * Modèle présenté avec skai Luxe kilt 105: + 50€
- * Modello come in foto, con tessuto Luxe kilt 105: + 50€
- * Sillón presentado con tapizado Luxe kilt 105: + 50€
- * Seater presented in Kilt105: +50€
- * Sessel in Kilt105 vorgestellt: +50€

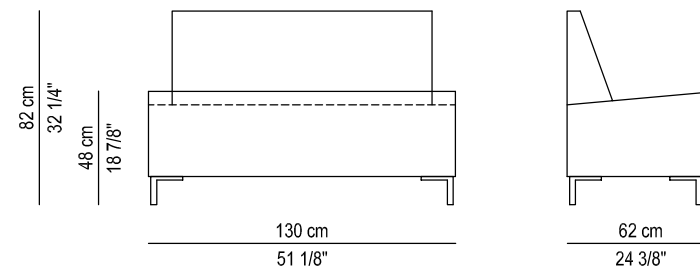
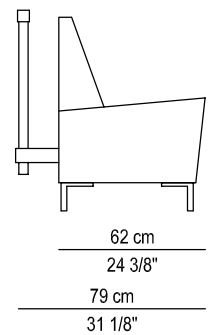

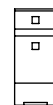
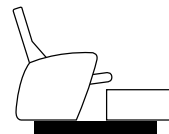
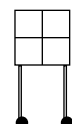
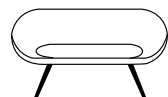
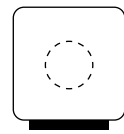
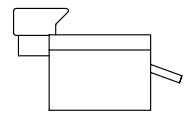
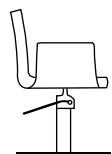
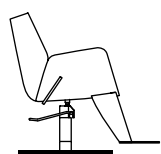
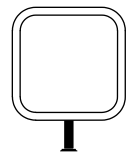

07

C H A R I O T S

C A R R E L L I

T R O L L E Y S

C A R R O S

S E R V I C E W A G E N



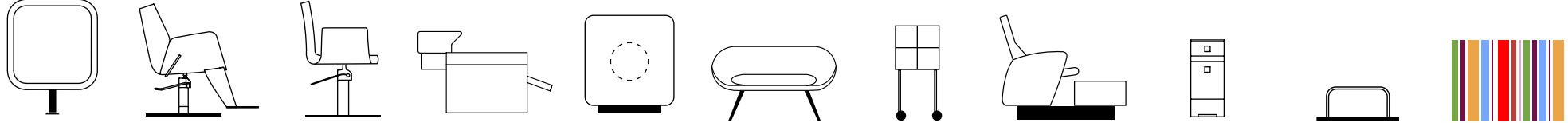

NELBY C

NELBY C

FS 200

€ 1.019,00

- Meublesurroulettes avec tiroirs intérieurs. Structure en méthacrylate blanc.
- Mobiletto su rotelle con struttura in metacrilato bianco apribile con cassetti interni.
- Trolley on castors with drawers. Structure in methacrylate available in white.
- Mueble sobre ruedas con cajones. Estructura de metacrilato blanco.
- Servicewagen auf Rollen mit Schubladen. Struktur aus Methacrylat nur in Weiß.

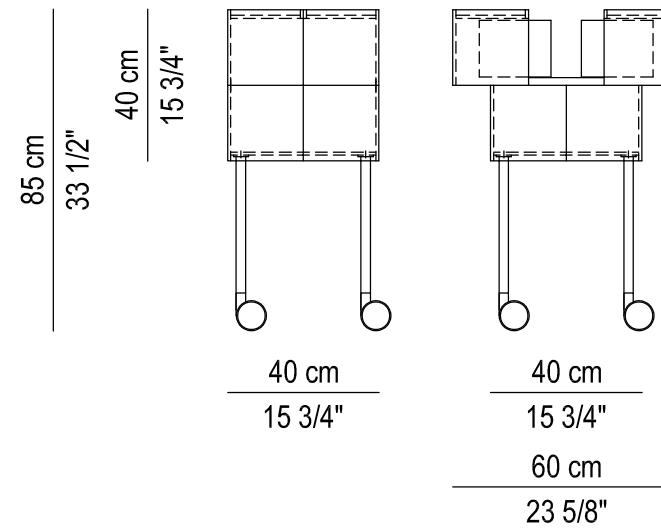

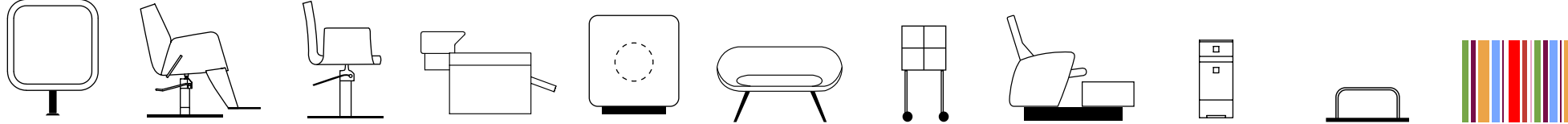

ROLLY

ROLLY NOIR

€ 635,00

FU 2300 N

- Meuble de rangement sur roulettes avec structure en plexi noir. Tiroirs noirs.
- Mobiletto su rotelle con struttura in metacrilato nero. Cassetti in nero.
- Trolley on castors with black plexiglas structure and black drawers.
- Mueble sobre ruedas de metacrilato negro. Cajones negros.
- Servicewagen auf Rollen. Struktur aus schwarzem Plexiglas und Schubladen aus schwarzem Plexi.

ROLLY BLANC

€ 635,00

FU 2300 B

- Meuble de rangement sur roulettes avec structure en plexi blanc. Tiroirs noirs.
- Mobiletto su rotelle con struttura in metacrilato bianco. Cassetti in nero.
- Trolley on castors with white plexiglas structure and black drawers.
- Mueble sobre ruedas de metacrilato blanco. Cajones negros.
- Servicewagen auf Rollen. Struktur aus weißem Plexiglas und Schubladen aus schwarzem Plexi.

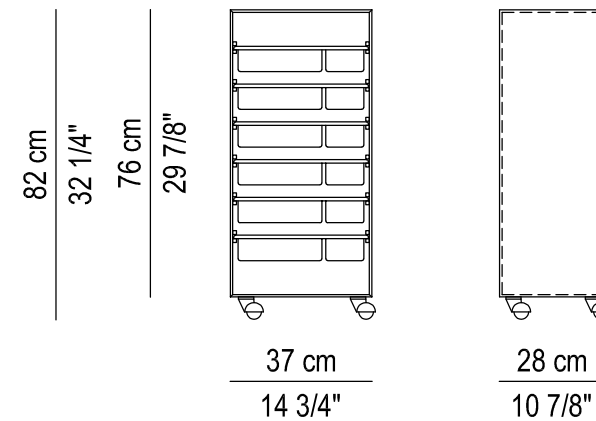

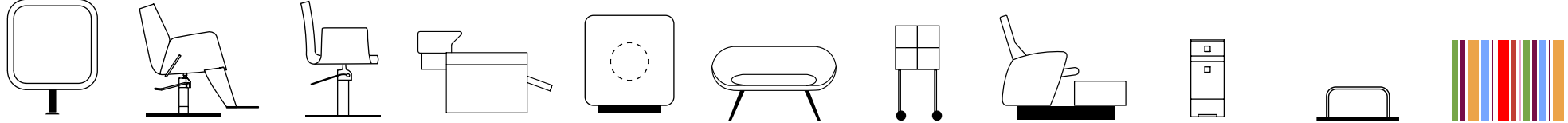

08

ESTHETIQUE
ESTETICA
BEAUTY
ESTÉTICA
ÄSTHETIK



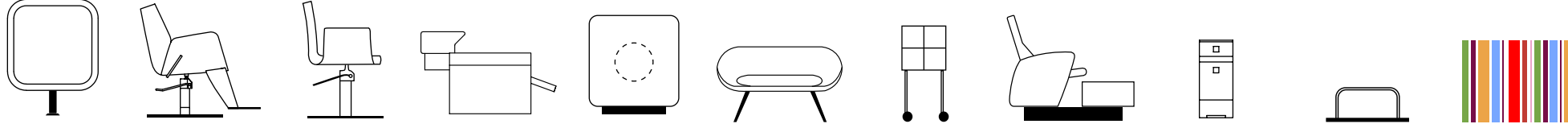

NELBYDRO



NELBYDRO

FS 100

€ 5.072,00

- Fauteuil pédicure pivotant avec dossier fixe et bac avec système hydromassant pour bain de pieds.
- Postazione pedicure con poltrona girevole, schienale fisso e vasca con sistema di idromassaggio "pipeless".
- Pedicure armchair with 180° swivel seat. Wash bowl with integrated pipeless foot massage system and adjustable footrest.
- Sillón de pedicura giratorio con respaldo fijo e hidromasaje.
- Pedikürestuhl mit einem Drehsessel. Becken mit Pipeless System für die Füße.

NELBYDRO SHIATSU

FS100M

€ 6.352,00

- Nelbydro avec massage à air Shiatsu.
- Nelbydro con massaggio Shiatsu.
- Nelbydro with Shiatsu massage.
- Nelbydro con masaje de aire Shiatsu.
- Nelbydro mit Shiatsu Massage.



ACCESSOIRE MANICURE

€ 258,00

- Par pièce, pezzo, piece, pieza, Stück

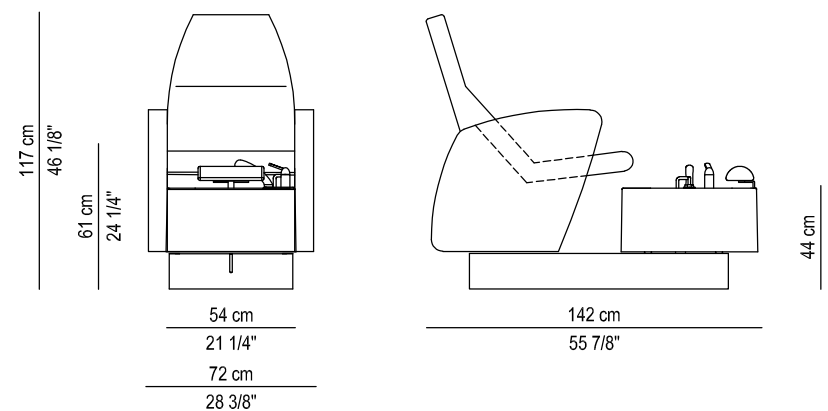

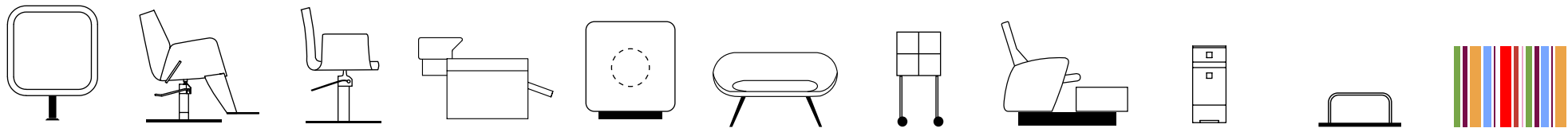

NELBY BED

NELBY BED

FS 300

€ 2.237,00

- Table de massage avec trou pour positionner la tête.
- Lettino massaggi con foro impronta per viso.
- Massage table with face hole.
- Mesa de masaje con agujero para la cara.
- Massagetisch mit Kopföffnung.

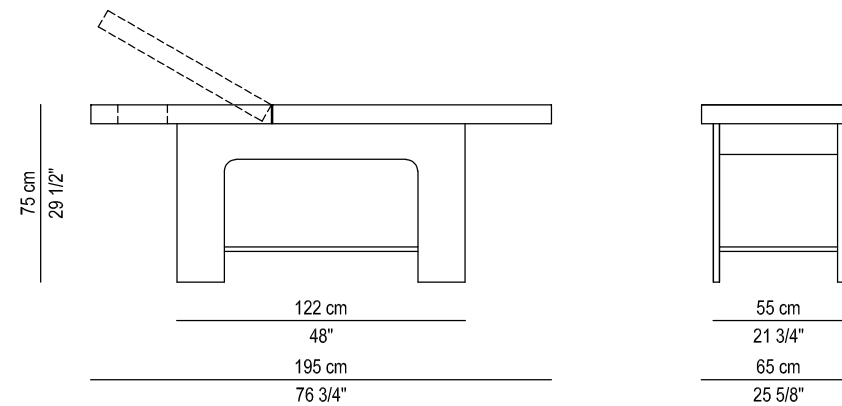

PORTE-ROULEAU

FS 300 PROUL

€ 76,00

- Porte-rouleau.
- Portarotolo.
- Roll-holder.
- Porta-rollo.
- Rollenhalter.



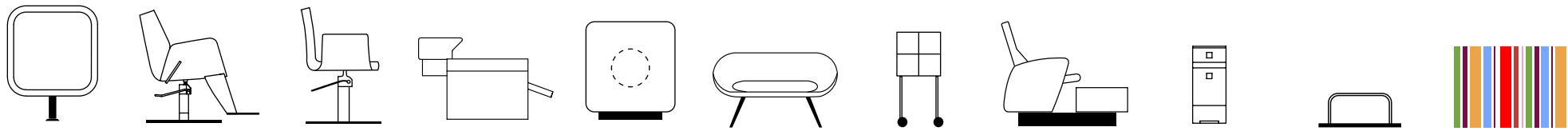

NELBY TAB



NELBY TAB

FS 400

€ 1.670,00

- Table de manucure en melaminé Blanc T31 avec électrification complète. Avec ou sans extracteur manucure. Configuration gauche ou droite.
- Postazione manicure in nobilitato Blanc T31 completo di elettrificazione. Piano con o senza motore aspiratore. Configurazione sinistra o destra.
- Manicure Table in laminate Blanc T31, cabled. Optional extractor fan available. Left or right-hand configuration.
- Mesa de manicura de melamina blanca Blanc T31 con electrificación completa. Con o sin extractor. Configuración izquierda o derecha.
- Nageltisch aus Laminate Blanc T31 mit oder ohne Absauger (Sonderzubehör). Links- oder Rechtsausführung.

EXTRACTEUR MANICURE 22W

FS 100BOL

€ 280,00

- Extracteur.
- Motore aspiratore.
- Extractor.
- Extractor.
- Absauger (Sonderzubehör)

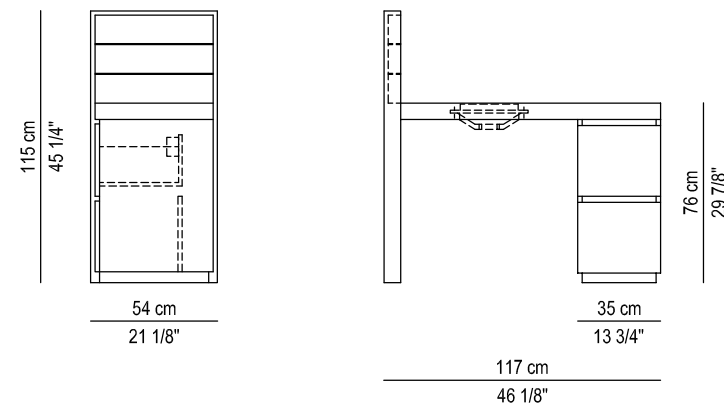

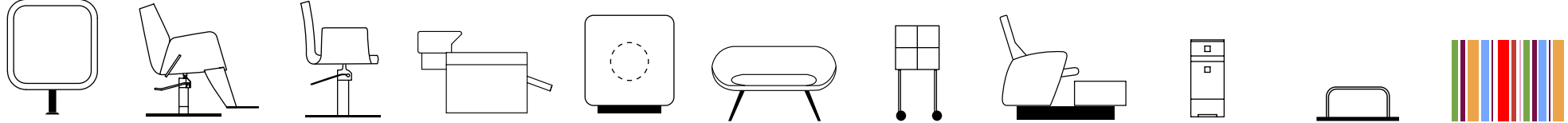

09

M E U B L E S

M O B I L I

F U R N I T U R E

M U E B L E S

M Ö B E L



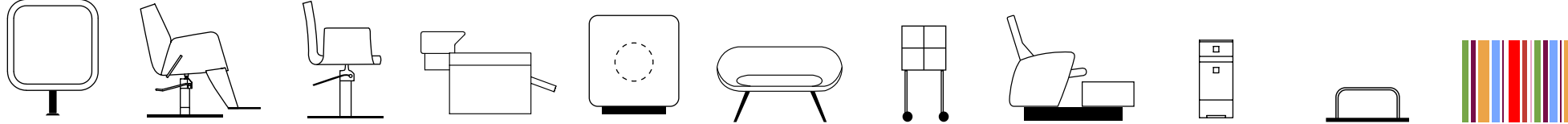

iDISPLAY "R"



IDISPLAY R

FJ 2000 V

€ 1.410,00

- Présentoir de vente rectangulaire vertical. Cadre en plexi noir ou blanc. Fond et étagères en plexi opale rétro-éclairé.
- Espositore da parete rettangolare in plexiglas opalino con illuminazione interna. Cornice perimetrale nero o bianco.
- Backlit vertical rectangular display with black or white Plexiglas frame and opal plexiglas back and shelves.
- Módulo de venta rectangular horizontal. Marco de metacrilato negro o blanco. Fondo y repisas de metacrilato ópalo iluminado.
- Verkaufsvitrine. Rahme aus schwarzem oder weißem Plexiglas. Rückseite und Regale aus weißem Plexiglas mit Beleuchtung.

IDISPLAY R

FJ 2000 H

€ 1.410,00

- Présentoir de vente rectangulaire horizontal. Cadre en plexi noir ou blanc. Fond et étagères en plexi opale rétro-éclairé.
- Espositore da parete rettangolare in plexiglas opalino con illuminazione interna. Cornice perimetrale nero o bianco.
- Backlit horizontal rectangular display with black or white plexiglas frame and opal plexiglas back and shelves.
- Módulo de venta rectangular horizontal. Marco de metacrilato negro o blanco. Fondo y repisas de metacrilato ópalo iluminado.
- Verkaufsvitrine. Rahme aus schwarzem oder weißem Plexiglas. Rückseite und Regale aus weißem Plexiglas mit Beleuchtung.

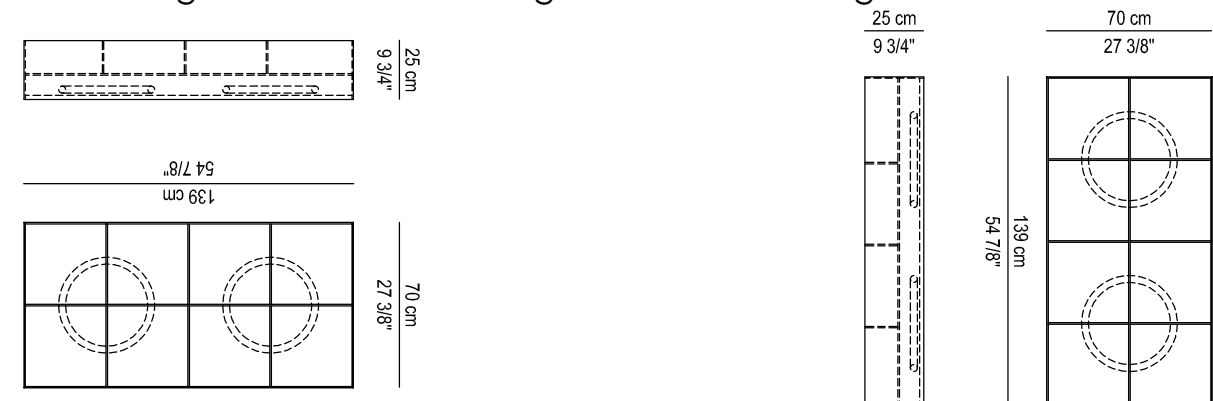

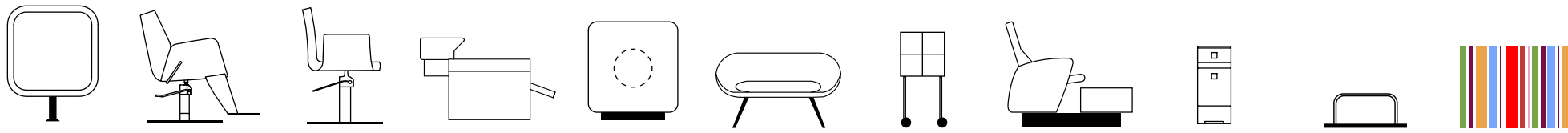

iDISPLAY "K"

IDISPLAY K

€ 909,00

FJ 3000

- Présentoir de vente carré. Cadre en plexi noir ou blanc. Fond et étagère en plexi opale rétro-éclairé.
- Espositore da parete quadrato in plexiglas opalino con illuminazione interna. Cornice perimetrale nero o bianco.
- Backlit square display unit with black or white plexiglas frame and opal plexiglas back and shelves.
- Modulo de venta cuadrado. Marco de metacrilato negro o blanco. Fondo y repisas de metacrilato ópalo iluminado.
- Verkaufsvitrine. Rahme aus schwarzem oder weißem Plexiglas Rückseite und Regale aus weißem Plexiglas mit Beleuchtung.

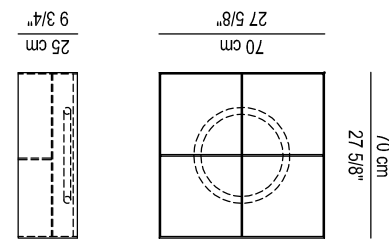

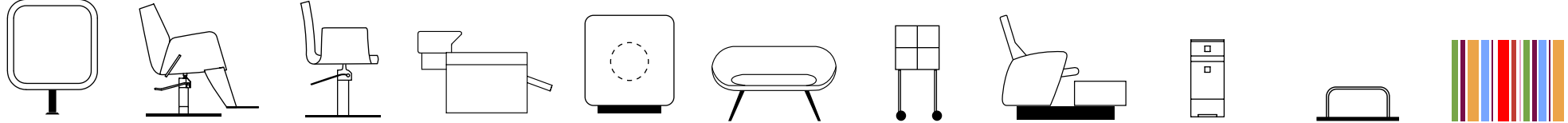

MIPIKO



MIDUO



MISOLO



MIDUPLEX

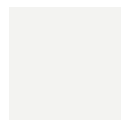

BLANC MAT



NOIR MAT



ORME CANNELLE

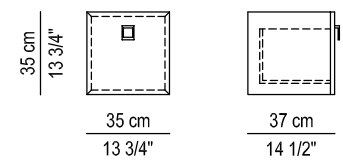
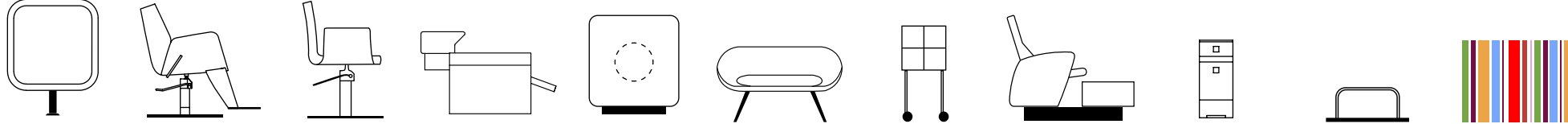

MIPIKO
FU 4050

€ 253,00

- Meuble de rangement. Tiroir avec poignée chromée.
- Mobiletto in "folding" con cassetto.
- Cabinet with drawer.
- Mueble de arreglo. Cajón con manilla cromada.
- Möbel mit Schublade.

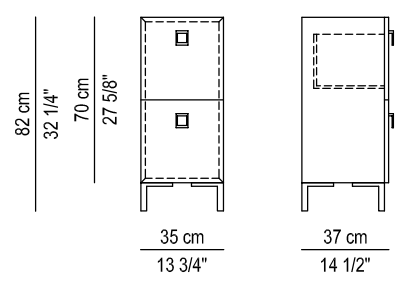

MIDUO
FU 2050

€ 529,00

- Meuble de rangement. 1 tiroir haut et 1 porte basse. Poignées chromées et pieds en aluminium.
- Mobiletto in "folding" con cassetto e anta. Piedini in alluminio.
- Cabinet with drawer and 1 door with aluminium feet.
- Mueble de arreglo con 1 cajón y 1 puerta. Manillas cromada y pies de aluminio.
- Möbel mit Schublade und einer Tür mit Füßen aus Aluminium.

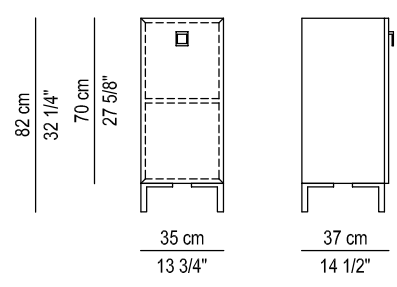

MISOLO
FU 3050

€ 496,00

- Meuble de rangement avec étagère. 1 porte. Pieds en aluminium.
- Mobiletto in "folding" con anta. Piedini in alluminio.
- Cabinet with 1 door with aluminium feet.
- Mueble de arreglo. 1 puerta. Pies de aluminio.
- Möbel mit Tür mit Füßen aus Aluminium.

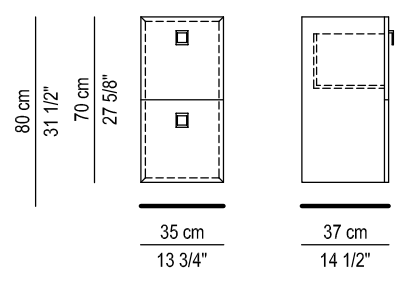

MIDUPLEX
FU 1050

€ 465,00

- Meuble suspendu. 1 tiroir haut et 1 porte basse. Poignées chromées.
- Mobiletto sospeso in "folding" con cassetto e anta.
- Suspended cabinet with drawer and door.
- Gabinete suspendido, 1 cajón superior y 1 puerta inferior. Manillas cromadas.
- Abgehängter Schrank mit Schublade und Tür.

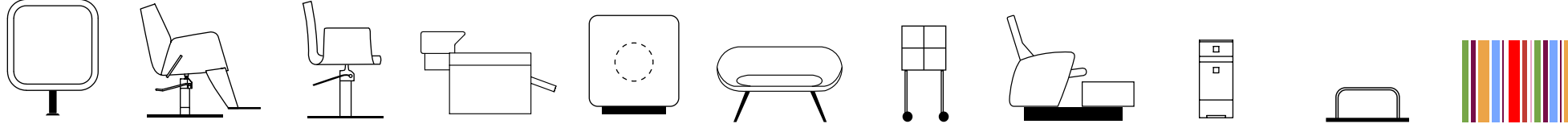

MODULAB



- Choix de modules pour créer un laboratoire personnalisé. Stratifié Blanc Luxe 31 seulement. Autres coloris au choix dans notre gamme avec supplément de 30%.
- Scelta di moduli per creare un laboratorio personalizzato. In color Blanc Luxe 31 unicamente. Altri colori disponibili con un ricarico del 30%.
- Selection of units to create a personalised colour bar. In laminate Blanc Luxe 31 as standard with a choice of other colours from our range at an upcharge of 30%.
- Elección de módulos para crear un laboratorio personalizado. Estratificado Blanc Luxe 3 únicamente. Otros colores a escoger en la gama con suplemento de un 30%.
- Auswahl an Bauteilen einem individualisieren Labor zu erstellen. Nur Laminatsfarbe Blanc Luxe 31. Andere Farbe von unserer Musterpalette mit 30% Aufpreis erhältlich.

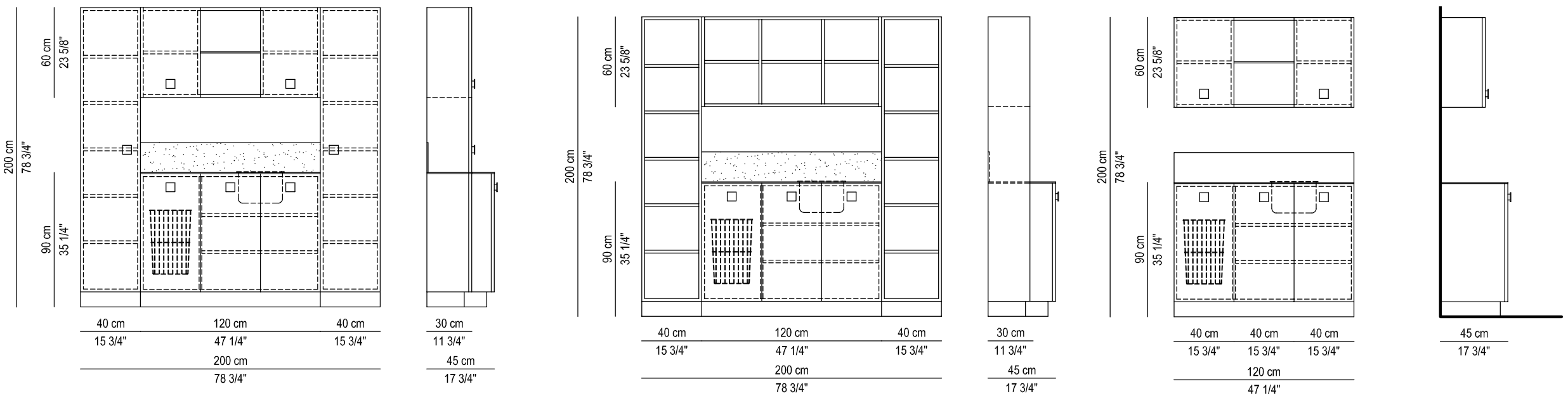

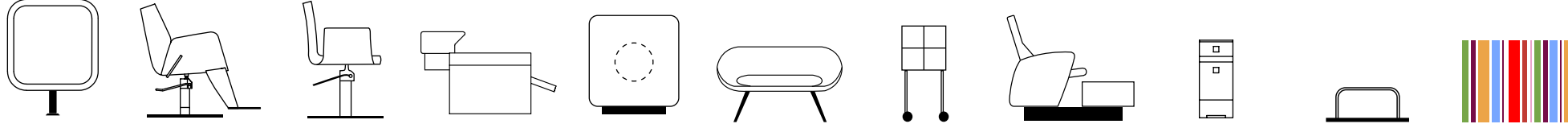

MOD.1

FK 400 1BP

€ 1.976,00

- Module partie basse avec plan de travail hydrofuge blanc "Fullcolor". Avec 3 portes et poignées en inox. Corbeille à serviettes incluse.
- Mobile base con 3 ante. Maniglie finitura cromata. Cesto per asciugamani incluso. Piano superiore idrorepellente colore bianco "Fullcolor".
- Base cabinet. White water "Fullcolor" repellent working top. With 3 doors and chromed handles. Towel basket included.
- Módulo parte inferior. Encimera hidrofuga con acabado blanco "Fullcolor". Con tres puertas. Tiradores de acero inoxidable. Cesto para toallas incluido.
- Unterschrank mit Wasserabstossender weisser "Fullcolor" Arbeitsfläche. Mit 3 Türen und Griffe aus Edelstahl. Handtücherkorb inkl.

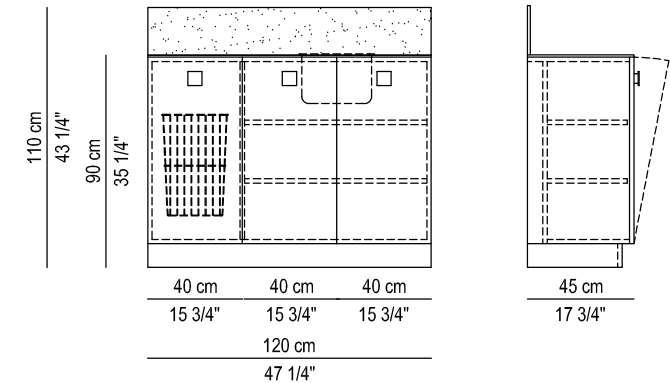

MITIGEUR MODULAB

FK MITI MODU

€ 163,00

- Mitigeur chromé.
- Miscelatore cromato.
- Chromed mixing tap.
- Monomando cromado.
- Verchromte Mischbatterie.



CUVETTE MODULAB

FK CUV MODU

€ 163,00

- Evier inox.
- Vasca in acciaio inox.
- Stainless steel bowl.
- Cubeta inox.
- Becken aus rostfreiem Stahl.



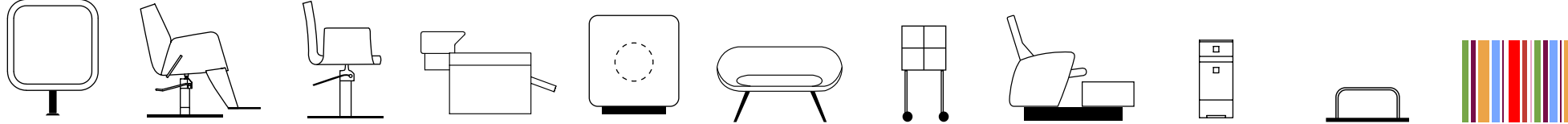

MOD.2

FK 400 2HS

€ 921,00

- Module haut sans porte.
- Pensile con vani a giorno.
- Wall cabinet without door.
- Módulo superior sin puerta.
- Hängeschrank ohne Tür.

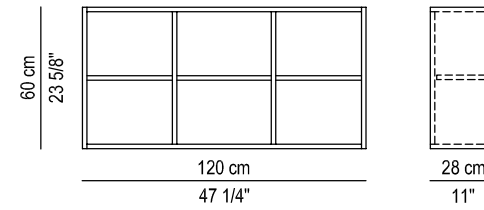

MOD.2P

FK 400 2HP

€ 1.014,00

- Module haut avec deux portes. Poignées en inox.
- Pensile con ante e vano a giorno. Maniglia finitura cromata.
- Wall cabinet with 2 doors. Chromed handles.
- Módulo superior con dos puertas. Tiradores de acero inoxidable.
- Hängeschrank mit zwei Türen. Griffe aus Edelstahl.

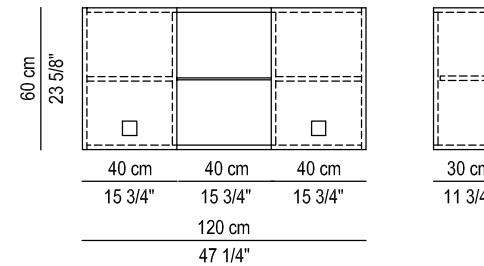

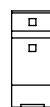
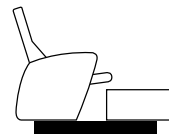
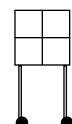
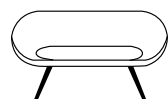
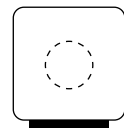
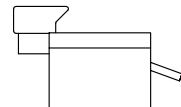
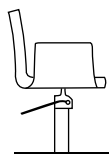
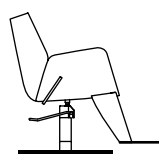
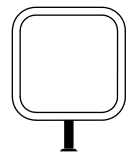
**MOD.3**

FK 400 3CS

€ 804,00

- Module colonne côté droit ou gauche sans porte.
- Colonna con vani a giorno.
- High cabinet left or right. Without door.
- Módulo columna lado derecho o izquierdo sin puerta.
- Hochschrank links oder rechts ohne Tür.

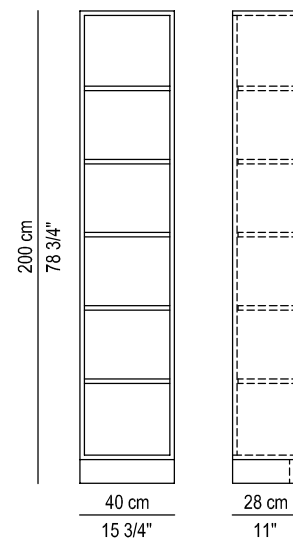
**MOD.3P**

FK 400 3CP

€ 897,00

- Module colonne côté droit ou gauche avec porte.
- Colonna con anta a dattente versione DX e SX. Maniglia finitura cromata.
- High cabinet left or right with a door. Chromed handles.
- Modulo columna lado derecho o izquierdo con puerta. Tiradores de acero inoxidable.
- Hochschrank links oder rechts mit zwei Türen. Griffe aus Edelstahl.

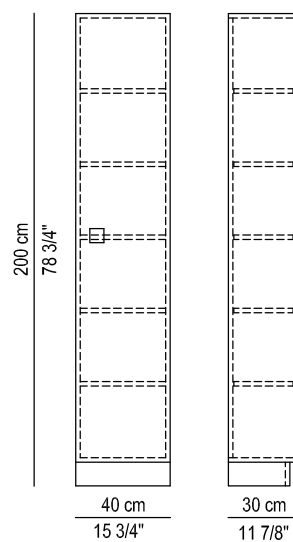

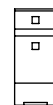
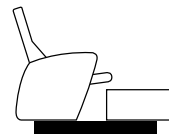
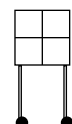
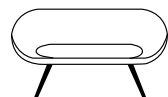
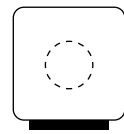
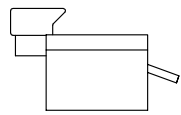
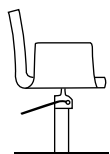
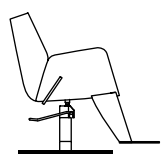
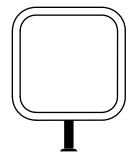

10

ACCESSOIRES

ACCESSORI

ACCESSORIES

ACCESORIOS

ZUBEHÖRTEILE



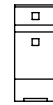
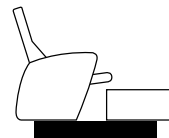
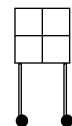
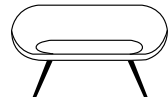
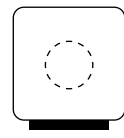
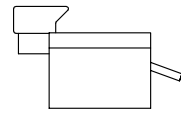
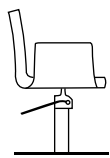
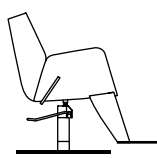
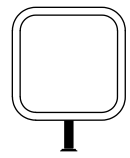

METAL OR

FM23000R

€ 234,00

- Repose-pieds en inox, finition or.
- Poggiapiedi in metallo finitura oro.
- Footrest in stainless steel, gold finish.
- Reposapiés de acero, acabado dorado.
- Fußstütze aus Edelstahl, im Gold-Finish



RP KRYS

FM 2100

€ 297,00

- Repose-pieds en acier Inox.
- Poggiapiedi in metallo cromato lucido.
- Footrest in stainless steel.
- Reposapiés de acero Inox.
- Fußstütze aus Edelstahl.



RP LINEAR

FM 2050

€ 157,00

- Repose-pieds en inox.
- Poggiapiedi in metallo cromato lucido.
- Footrest in stainless steel.
- Reposapiés de acero inoxidable.
- Fußstütze aus Edelstahl.



RP IRON

FM 2000

€ 198,00

- Repose-pieds en acier Inox et epoxy noir.
- Poggiapiedi in alluminio lucido e base in epoxy nero.
- Footrest in stainless steel and black epoxy
- Reposapiés de acero Inox y epoxy negro.
- Fußstütze aus Edelstahl und schwarzem Epoxy.



METAL

FM 2300

€ 117,00

- Repose-pieds en métal découpe laser finition chrome.
- Poggiapiedi in metallo lavorato a laser finitura cromato lucido. Finitura esterna cromato lucido.
- Laser cut, metal footrest in chrome finish.
- Reposapiés de metal con acabado cromado.
- Fußstütze aus Metall verchromt – laserschneiden.

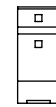
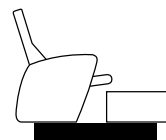
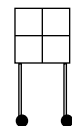
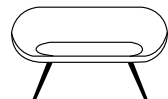
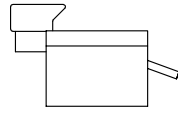
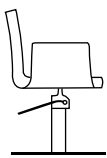
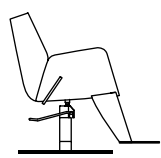
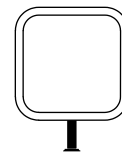
**EASY**

FM 1500

€ 58,00

- Support-séchoir en aluminium poli.
- Portaphon in alluminio lucidato.
- Hairdryer holder in polished aluminium.
- Porta-secador de aluminio pulido.
- Föhnhalter aus poliertem Aluminium.

**RP KRYPSTAL 1P MURALE OU CENTRALE**

FM7001

€ 163,00

RP KRYPSTAL 2P MURALE OU CENTRALE

FM 7002

€ 291,00

RP KRYPSTAL 3P MURALE OU CENTRALE

FM 7003

€ 396,00

- Repose-pieds en inox, poggiapiedi in metallo cromato lucido, Footrest in stainless steel, Reposapiés de acero inoxidable, Fußstütze aus Edelstahl.

**PORTEX**

FM 1600

€ 42,00

- Support-séchoir en plexiglas noir.
- Portaphon in metacrilato nero.
- Hairdryer holder in black plexiglas.
- Porta-secador de metacrilato negro.
- Föhnhalter aus schwarzem Plexiglas.

**SUP 63P (Ø:8,7 CM)**

FM 63P

€ 47,00

- Support-séchoir avec platine. Coloris : argenté ou chromé.
- Portaphon sottopiano. Colori : argento o cromato.
- Hair dryer holder with fixing plate. Colours : silver or chromed.
- Porta-secador con platina. Colores: plateado o cromado.
- Föhnhalter mit Befestigungsplatte. Farben: silber oder chrom.

**FLUTE**

FM 400

€ 256,00

- Support-séchoir sur pied en métal coloris noir et tube chromé.
- Portaphon da terra in metallo colore nero, anello plexiglass nero, supporto cromato.
- Freestanding metal hairdryer holder in black with chromed support.
- Porta-secador de metal color negro y pie cromado.
- Standföhnhalter aus Metl, schwarzer Farbe und Chromröhre.

**SACS PAPIER R'SPIRO X 10**

FU 2285SACP

€ 17,00

**SAC TISSU R'SPIRO**

FU 22855AC

€ 23,00

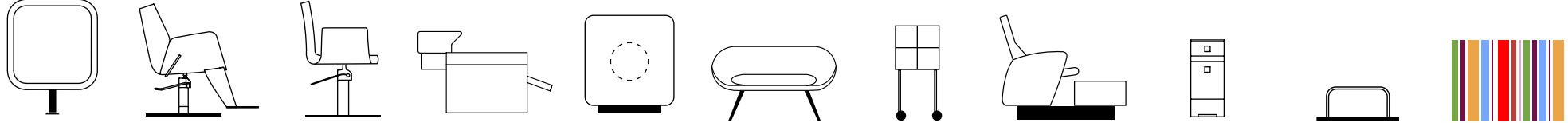

COLGEL
FA COLGEL

€ 38,00



- Protège cou silicone à ventouse.
- Protezione collo in silicone con ventosa.
- Silicone neck protection for basin.
- Collarin de silicona con ventosas.
- Nackenschutz aus Silikon.

COL

FA COL

€ 22,00



- Protège cou pour cuvette.
- Protezione collo vasca.
- Neck protection.
- Collarin para cubeta cerámica.
- Nackenschutz.

TÉLÉCOMMANDE SHIATSU
FA TELE SHIATSU

€ 140,00



- Télécommande pour repose-jambes électrique et massage à air Shiatsu.
- Telecomando per poggiatesta elettrico e sistema di massaggio totale Shiatsu.
- Remote control for electrical leg rest and Shiatsu Air massage system.
- Mando para apoyapiernas eléctrico y Sistema de masaje Shiatsu.
- Fernbedienung für elektrische Beinauflage und Shiatsu Luftmassage.

TÉLÉCOMMANDE RJ ELECTRIC

FA TELE RJ

€ 70,00



- Télécommande pour repose-jambes électrique.
- Telecomando per poggiatesta elettrico.
- Remote control for electrical leg rest.
- Mando para apoyapiernas eléctrico.
- Fernbedienung für elektrische Beinauflage.

FILLER UNIVERSEL
FA FILLER U

€ 431,00

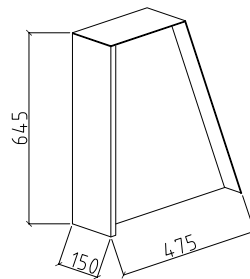

TABLETTE EN VERRE
DECO/ GRAPHOS /OVALIS/RECTANGULUM
FFPROTABV8000

€ 99,00

TABLETTE EN VERRE SPEKY / MAGNUM
FFPROTABV3600

€ 99,00

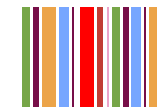
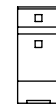
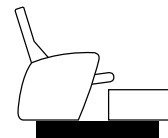
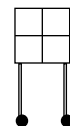
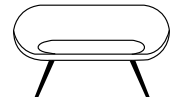
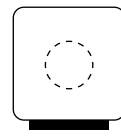
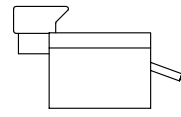
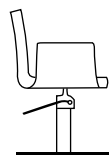
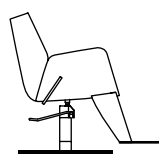
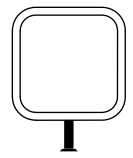

HOUSSE LUXE BAC RJ

FA HT RJ L

€ 52,00



- Housse de protection pour repose-jambes. Indiquer modèle.
- Copertina di protezione luxe per poggiatesta. Indicare modello.
- Protective cover for wash units (leg rest). State model required.
- Funda de protección para apoyapiernas. Indicar modelo.
- Schutzhülle für Waschsessel (Beinstütze). Modell zu nennen.

HOUSSE LUXE BAC DOSSIER

FA HT L

€ 52,00



- Housse de protection pour dossier de bacs: indiquer modèle.
- Copertina di protezione luxe per lavaggi: indicare modello.
- Protective cover for wash units (backrest): state model required.
- Funda de protección para lavacabezas: indicar modelo.
- Schutzhülle für Waschsessel (Rückenlehne): modell zu nennen.

HOUSSE LUXE SOFA 2P

FA HT3002L

€ 87,00



- Housse de protection pour dossier de sofa 2P.
- Copertina di protezione luxe per lavaggi.
- Protective cover for sofa (backrest).
- Funda de protección para lavacabezas sofa 2P.
- Schutzhülle für sofa (Rückenlehne).

HOUSSE LUXE SOFA 3P

FA HT3003L

€ 111,00



- Housse de protection pour dossier de sofa 3P.
- Copertina di protezione luxe per lavaggi.
- Protective cover for sofa (backrest).
- Funda de protección para lavacabezas sofa 3P.
- Schutzhülle für sofa (Rückenlehne).

HOUSSE LUXE

FB HT L

€ 52,00



- Housse de protection luxe. Indiquer modèle fauteuil.
- Copertina di protezione luxe. Indicare modello poltrona.
- Protective cover luxe. Indicate chair model.
- Funda de protección luxe. Indicar modelo sillón.
- Schutzhülle Luxe. Nennen Sie uns das Stuhlmodell.

CUBE, OPEN, SUE

€ 74,00

COSTE'S

€ 95,00

HOUSSE TELECOMMANDE

FA HT TELEC

€ 19,00



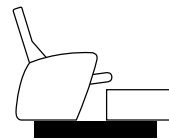
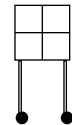
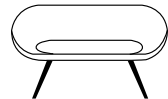
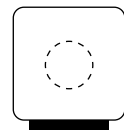
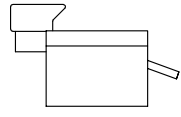
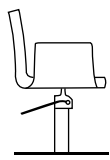
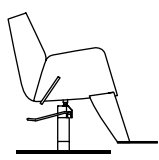
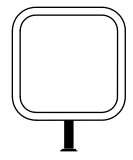

CUVETTE CARRÉE BLANCHE

FA CCB

€ 490,00



- Cuvette carrée blanche.
- Vasca quadrata colore bianco.
- White square wash bowl.
- Cubeta blanca cuadrada.
- Weißes tiefes Keramikbecken.

CUVETTE CARRÉE NOIRE

FA CCN

€ 600,00



- Cuvette carrée noire.
- Vasca quadrata colore nero.
- Black square wash bowl.
- Cubeta negra cuadrada.
- Schwarzes tiefes Keramikbecken.

CUVETTE OCEANE BLANCHE

DYNAMIK/RADIAN/ECLISSE/KOMBI/STYLWASH

FA CUVOCB

€ 443,00



- Cuvette profonde "Oceane" Blanche.
- Vasca profonda "Oceane" color bianco.
- White deep "Oceane" wash bowl.
- Cubeta blanca profunda "Oceane".
- Weißes tiefes Keramikbecken "Oceane".

CUVETTE OCEANE NOIRE

DYNAMIK/RADIAN/ECLISSE/KOMBI/STYLWASH

FA CUVOCN

€ 554,00



- Cuvette profonde "Oceane" Noire.
- Vasca profonda "Oceane" color nero.
- Black deep "Oceane" wash bowl.
- Cubeta negra profunda "Oceane".
- Schwarzes tiefes Keramikbecken "Oceane".

CUVETTE HOL 3 BLANCHE

TOPWASH/GOWASH

FA CUVHOLB3

€ 443,00



- Cuvette profonde "Hol 2" Blanche.
- Vasca profonda "Hol 2" color bianco.
- White deep "Hol 2" wash bowl.
- Cubeta blanca profunda "Hol 2".
- Weißes tiefes Keramikbecken "Hol 2".

CUVETTE HOL 2 NOIRE

TOPWASH/GOWASH

FA CUVHOLN

€ 554,00



- Cuvette profonde "Hol 2" noire.
- Vasca profonda "Hol 2" color nero.
- Black deep "Hol 2" wash bowl.
- Cubeta negra profunda "Hol 2".
- Schwarzes tiefes Keramikbecken "Hol 2".

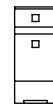
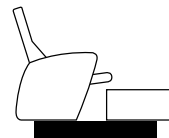
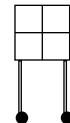
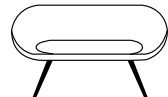
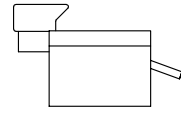
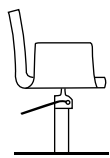
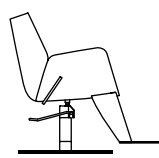
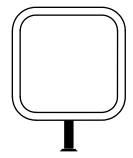

ARMOR

FA CUVARMOR

€ 245,00



- Cuvette profonde «Armor» blanche.
- Vasca per lavaggio ARMOR colore bianco.
- White deep « Armor » wash bowl.
- Cubeta profunda blanca "Armor".
- Weißes Tiefes Keramikbecken "Armor".

SUPLÉMENT CUVETTE NOIRE CARREE / OCEANE / HOL 2

SUPCCN

€ 111,00



- Supplément pour cuvette noire.
- Suplemento vasca nera.
- Extra charge for black washbasin.
- Suplemento cubeta negra.
- Aufpreis für schwarzes Becken.

MITIGEUR MITIMAX

FA MITIMAX

€ 157,00



- Mitigeur.
- Miscelatore.
- Mixing tap.
- Monomando.
- Mischbatterie

ACQUASTOP

FAAQUA

€ 49,00



- Support-douchette spécial antigoutte (livré sans douchette).
- Supporto per doccia anti-goccia (senza doccia).
- Anti-drip shower support (delivered without shower).
- Soporte ducha especial anti gota (entregado sin ducha).
- Anti-Tropf Brausehalter (Ohne Brause).

BONDE SIPHOIDE OCÉANE

FA EEO

€ 99,00



- Ensemble d'évacuation avec bonde siphöide pour cuvette Océane.
- Funzione di scarico con le spine ed il sifone di scarico per vasca Océane.
- Outlet assembly including waste trap valve for Nelson wash bowl.
- Conjunto de evacuación con tapa y sifón para cubeta Océane.
- Ablaufventile mit Geruchverstopper und Siphon für Océane Becken.

BONDE SIPHOIDE HOL

FA EE CH

€ 99,00

BONDE SIPHOIDE CUV. CARREE

FA EE OC

€ 99,00

BONDE SIPHOIDE ARMOR

FA EE ARMOR

€ 52,00

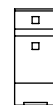
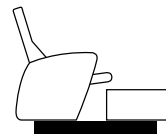
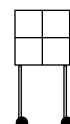
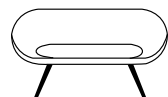
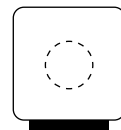
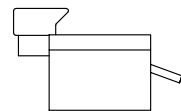
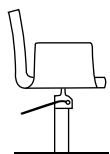
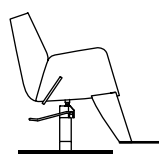
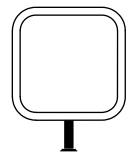

SYSTEME OSCILLANT OCÉANE

FA 96

€ 111,00



- Système oscillant pour cuvette Océane et carrée.
- Sistema oscillante per vasca Océane e quadrata.
- Tilting system for Océane and square wash bowl.
- Sistema basculante para cubeta Océane y cuadrada.
- Kippbares System für Océane oder quadratisch Becken.

SYSTEME OSCILLANT HOL

FA 96 HOL2

€ 111,00

SYSTEME OSCILLANT ARMOR

FA 96 ARMOR

€ 111,00

DOUCHETTE CHROMÉE

FA DCB

€ 41,00



- Douchette chromée.
- Doccia cromata.
- Chromed hand shower.
- Ducha cromada.
- Verchromte Handbrause.

DOUCHETTE NOIRE

FA DNB

€ 37,00



- Douchette Noire.
- Doccia nera.
- Black hand shower.
- Ducha negra.
- Schwarze Handbrause.

SUPPORT DOUCHETTE

FA SDB

€ 29,00



- Support douchette.
- Supporto doccia.
- Support for hand shower.
- Soporte ducha.
- Halter für Handbrause.

PROTEGE COU COL BLISTER

FA COL B

€ 23,00



- Protège cou pour cuvette.
- Protezione collo vasca.
- Neck protection for basin.
- Collarin para cubeta.
- Nackenschutz für Becken.

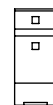
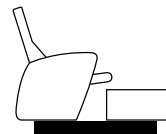
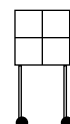
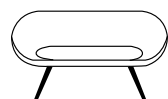
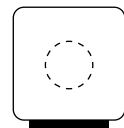
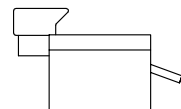
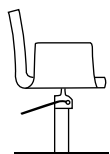
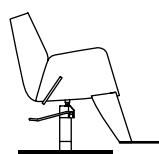
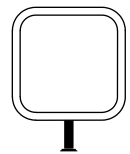

CORPS MITIMAX

FA 80 MAX B

€ 128,00



- Corps de mitigeur Mitimax.
- Corpo di miscelatore Mitimax.
- Mitimax body tap.
- Cuerpo de monomando Mitimax.
- Mischbatterie Korpus.Mitimax

ECONOMISEURS D'EAU

FA MESTD B

€ 29,00



- 4 Economiseurs d'eau.
- 4 Limitatori d'acqua.
- 4 Water consumption reducers.
- 4 Limitadores de caudal.
- 4 Durchsatzbegrenzer.

CARTOUCHE CERAMIQUE MITIMAX

FA 81 MAX B35

€ 47,00



- Cartouche céramique pour mitigeur Mitimax ø 35.
- Cartuccia di ceramica per la valvola di miscelazione Mitimax ø 35.
- Ceramic cartridge for mixing tap Mitimax ø 35.
- Cartucho de cerámica para monomando Mitimax ø 35.
- Keramikscheibendichtung für Mischbatterie Mitimax ø 35.

AERATEURS D'EAU

FA MSTD B

€ 26,00



- 4 Aérateurs d'eau.
- 4 Aeratori d'acqua.
- 4 Water aerators.
- 4 Aeradores de agua.
- 4 Wasserbelüfter.

FLEXIBLE DOUCHETTE

FA FLDB

€ 22,00



- Flexible douchette.
- Flessibile per doccia.
- Hose for shower.
- Flexo para mango de ducha.
- Brauseschlauch.

ANTIGOUTTE DOUCHETTE

CAANTIGOUTT.PNR

€ 3,00



FLEXIBLE DOUCHETTE GRIS LONG

CA87FLEX002.PNR

€ 14,00



FLEXIBLE DOUCHETTE GRIS COURT

CA87FLEX001.PNR

€ 14,00



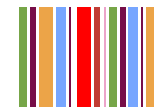
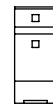
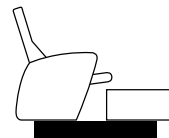
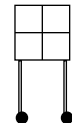
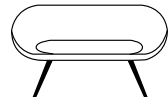
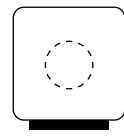
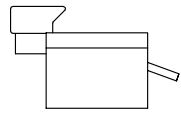
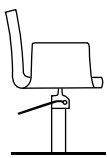
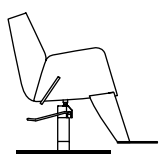
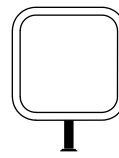

ROULE

FB ROULE

€ 6,00



- Roulette en nylon, démontable, adaptable sur les bases de fauteuils.
- Ruota di plastica, smontabile e adattabile a tutte le poltrone.
- Plastic castors, can be dismantled, adaptable on all chairs.
- Ruedas de plástico, desmontables y adaptables a todos los sillones.
- Auswechselbare Kunststoffrollen, für alle Frisierstühle lieferbar.

ROULE FREIN

FB ROULEFR

€ 7,00



- Roulette en nylon avec frein, démontable et adaptable sur les bases de fauteuils.
- Ruota di plastica con freno, smontabile e adattabile a tutte le poltrone.
- Plastic castors with brake, can be dismantled, adaptable on all chairs.
- Ruedas de plástico con freno, desmontables y adaptables a todos los sillones.
- Auswechselbare Kunststoffrollen mit Bremse, für alle Frisierstühle lieferbar.

ROULUX

FB ROULUX

€ 8,00



- Roulette "Luxe" en gomme grise (pour plus de confort), démontable et adaptable sur les bases de fauteuils.
- Ruota di gomma (più comoda) smontabile e adattabile a tutte le poltrone.
- Rubber castors (for hard floors), can be dismantled, adaptable on all chairs.
- Ruedas de goma (para más comodidad) desmontables y adaptables a todos los sillones.
- Auswechselbare Gummirollen (für mehr Komfort) für alle Frisierstühle lieferbar.

ROULUX FREIN

FB ROULUXFR

€ 10,00



- Roulette "Luxe" avec frein, en gomme grise (pour plus de confort), démontable et adaptable sur les bases de fauteuils.
- Ruota di gomma con freno (più comoda), smontabile e adattabile a tutte le poltrone.
- Rubber castors with brake (for hard floors) can be dismantled, adaptable on all chairs.
- Ruedas de goma con freno (para más confort) desmontables y adaptables a todos los sillones.
- Auswechselbare Gummirollen mit Bremse (für mehr Komfort) für alle Frisierstühle lieferbar.

FRENUM

FB FRENUM

€ 256,00



- Frein pour base équipée de roulettes, pour pompe hydraulique seulement. Prix incluant 5 roulettes.
- Freno per base con ruote, solo per pompa idraulica. Il prezzo include 5 ruote.
- Brake for 5 star base with castors, for hydraulic pump only. Price includes 5 castors.
- Freno para base con ruedas, sólo para bomba hidráulica. Precio incluyendo 5 ruedas.
- Roller und Stopper für Kreuzfuß, nur für hydraulische Pumpe. Preis inkl. 5 Rollen.



ACCESSORIES -SUPPLÉMENT REPOSE-PIEDS

RP11 PF

€ 210,00



- Repose-pieds pour fauteuil.
- Poggiapiedi per poltrona.
- Footrest for chair.
- Apoyapiés para sillón.
- Fußstütze für Stuhl.

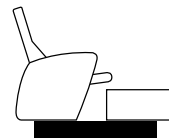
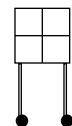
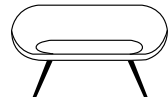
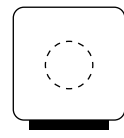
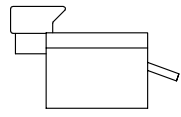
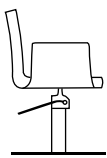
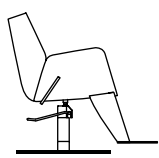
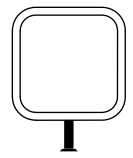

REHAUSSEUR 53

FM 53

€ 93,00



- Pouf de coiffage (hauteur 17 cm). Noir uniquement.
- Cuscino da taglio (alto 17 cm). Solo in nero.
- Pouf for chair (17 cm high). Black only.
- Cojín de corte (altura 17 cm). Solo Negro.
- Kindersitzkissen (Höhe 17 cm). Nur schwarz.

REHAUSSEUR 53A

FM 53A

€ 70,00



- Pouf adultes (hauteur 8 cm). Noir uniquement.
- Cuscino da taglio per adulti (altezza 8 cm). Solo in nero.
- Pouf cushion in black only (height 8cm).
- Cojin de corte adultos (altura 8 cm). Solo Negro.
- Sitzkissen für Erwachsene (Höhe 8 cm). Nur schwarz.

REHAUSSEUR 55

FM 55

€ 87,00



- Pouf de coiffage ou lavage uperposable (hauteur 8 cm). Noir uniquement.
- Cuscino sovrapponibile da taglio o lavaggio (altezza 8 cm). Solo in nero.
- Pouf for chair or wash unit (8 cm high). Black only.
- Cojín superponible de corte o de lavabo (altura 8 cm). Solo negro.
- Kindersitzkissen für Stuhl oder Waschplatz (Höhe 8cm). Nur schwarz.

REHAUSSEUR 54

FM 54

€ 93,00



- Pouf enfants spécial bac de lavage (hauteur 17 cm). Noir uniquement.
- Cuscino speciale per bambini per lavaggio, (altezza 17 cm). Solo in nero.
- Child wash unit pouf, black only, (height 17cm).
- Cojin para niños especial para lavacabezas (altura: 17 cm). Solo negro.
- Kindersitzkissen für Waschplatz (Höhe 17 cm). Nur schwarz.

TUBE COULISSANT

FQCOULL

€ 23,00



- Tube coulissant porte-casque.
- Tubo scorrevole porta casco.
- Sliding tube.
- Tubo deslizante.
- Gleitrohr.

SYSTEME PORTE CASQUE + FUT MURAL

FM SPCFMUR

€ 134,00



- Systeme porte-casque mural.
- Supporto portacasco a parete.
- Hairdryer holder system for wall fixation.
- Sistema porta-casco para pared.
- Haubenthalterung für Wandbefestigung.

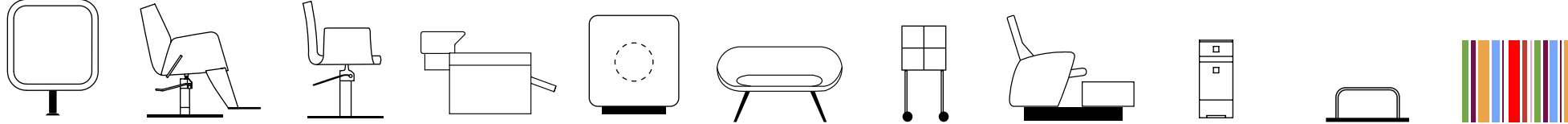

TABLETTE PMR AMOVIBLE

€ 437,0

STPMR AMO

- Supplément Tablette PMR.
- Suplemento ripiano per portatori di handicap.
- Extra charge for shelf for disabled people.
- Costo adicional por repisa minusválidos móvil.
- Zuschlag für Für Ablage für behinderten Menschen.

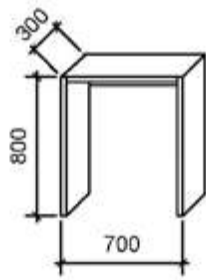

LUMY II MAX / MEDIUM

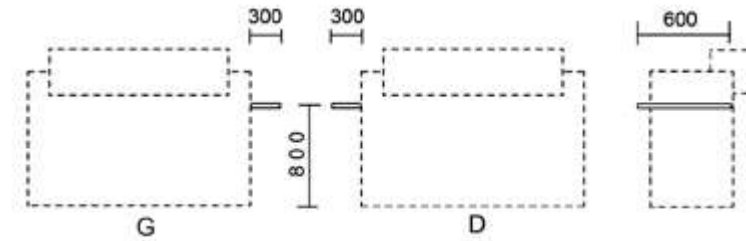

TABLETTE PMR

€ 192,00

STPMR

- Supplément Tablette PMR.
- Suplemento ripiano per portatori di handicap.
- Extra charge for shelf for disabled people.
- Costo adicional para repisa minusvalidos.
- Zuschlag für Für Ablage für behinderten Menschen.

IECO

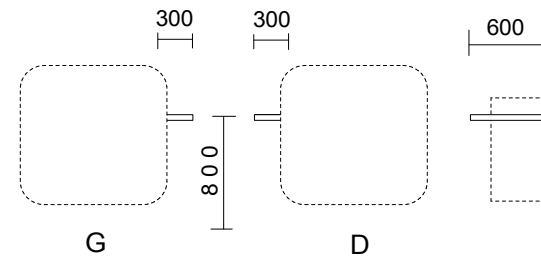

IDESK

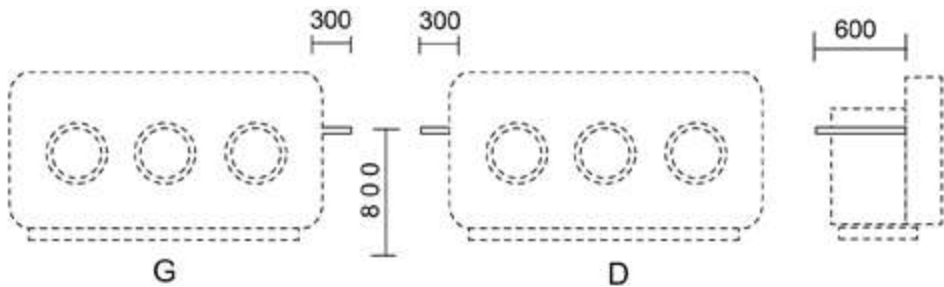

IDESK MEDIUM

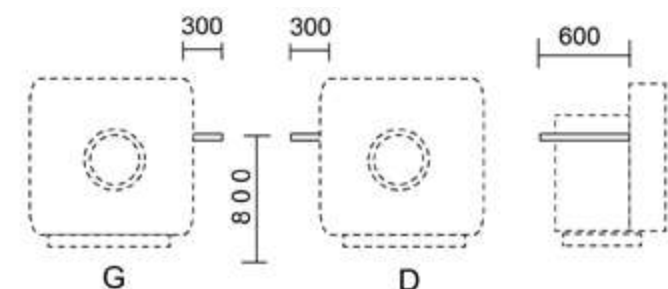

TETIERE

€ 199,00

FB TETG

- Têtière disponible uniquement sur Charme, Mania, Open, Suite.
- Poggiatesta disponibile solamente per Charme, Mania, Open, Suite.
- Headrest for Charme, Mania, Open, Suite chairs only.
- Apoyacabeza adaptable a los sillones Charme, Mania, Open, Suite.
- Kopfstütze möglich für folgende Modelle: Charme, Mania, Open, Suite.

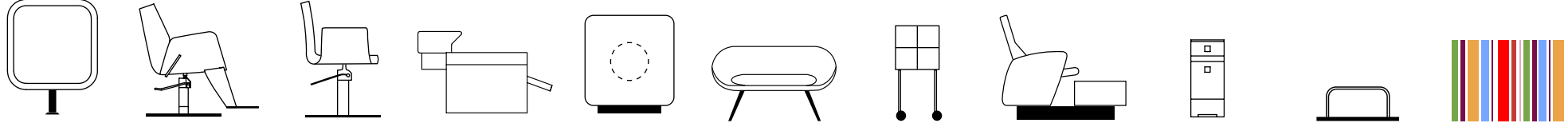

11

C O L O R I S
C O L O R I
C O L O R S
C O L O R E S
F A R B E N

< > >

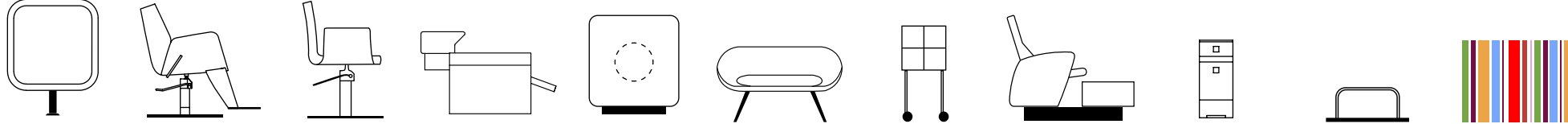

SKAI SKAY SKAY TAPIZADO BEZUG



Gun
Noir 111*



Gun Gris
Foncé 112*

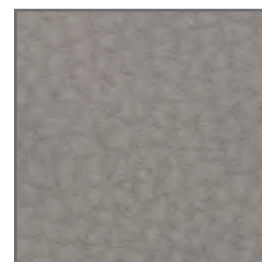

Gun
Gris 113*



Gun
Ivoire 116*

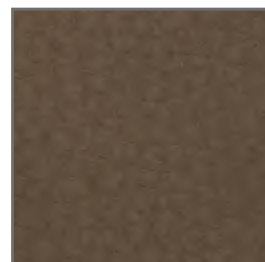

Gun
Argile 117*

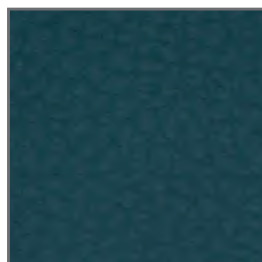

Gun
Octane 114*

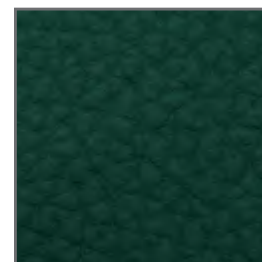

Gun
Vert 118*

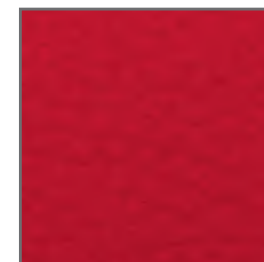

Gun
Rouge 115*



Nuit 71*

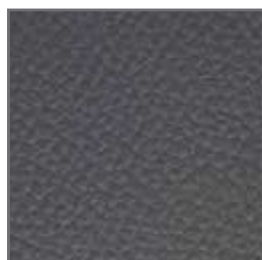

Cendre 65*



Neige 78*



Café 59**



Noix 101***



Ocean 106***



Bordeaux 19*

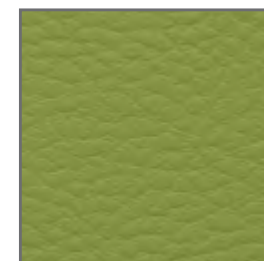

Vert 119*

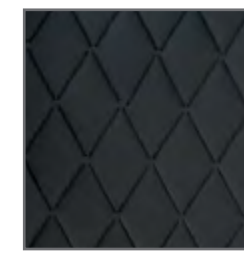

Kilt 105*

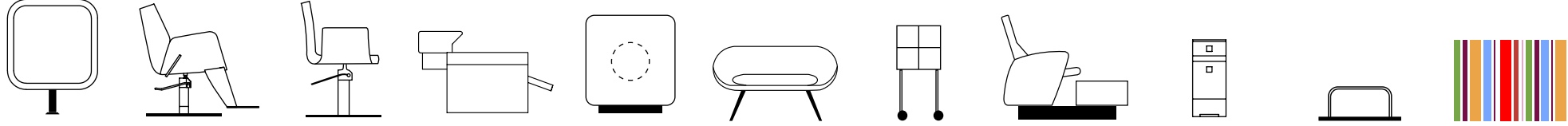

VELOURS VELLUTO VELVET TERCIOPELO SAMT



Soleil V16

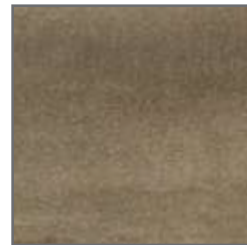

Noisette V17



Olive V18



Verdier V19



Bleu Pétrole V20



Bleu V21



Noir V22



Rouge V23

*** VERSION LUXE**

SKAI

- AVEC SUPPLÉMENT, PAR PLACE 50€
- CON SUPPLEMENTO PER POSTO 50€
- WITH SUPPLEMENT PER SEAT 50€
- CARGO ADICIONAL POR PLAZA 50€
- MIT PREISAUFSCHLAG PRO PLATZ 50€

* IGNIFUGO 1.IM

** NON FEU M2

OPTION BICOLORE

SKAI

- AVEC SUPPLÉMENT, PAR PLACE 55€
- CON SUPPLEMENTO PER POSTO 55€
- WITH SUPPLEMENT PER SEAT 55€
- CARGO ADICIONAL POR PLAZA 55€
- MIT PREISAUFSCHLAG PRO PLATZ 55€

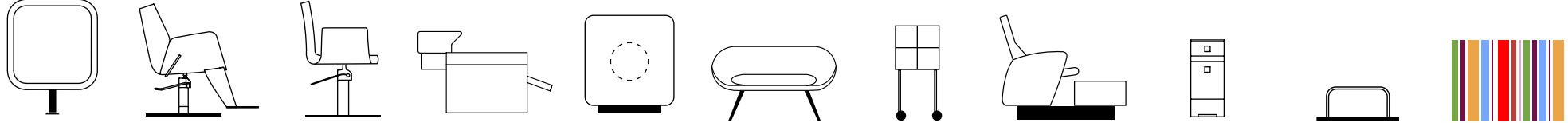

STRATIFIÉ LAMINATO LAMINATED FINISH ESTRATIFICADO REPROHOLZFARBEN



Orme Cannelle T11



Montreal T10



Plomb T62



Silver 13



Jute T27



Lino T26



Blanc T41
Blanc Luxe T31**
Blanc Acrylic T05**



Noir T42
Noir Luxe T15**
Noir Acrylic T06**

**** PRESTIGE**

STRATIFIÉ

- AVEC SUPPLÉMENT +30%
- CON SUPPLEMENTO +30%
- WITH SUPPLEMENT +30%
- CARGO ADICIONAL +30%
- MIT PREISAUFSCHLAG +30%

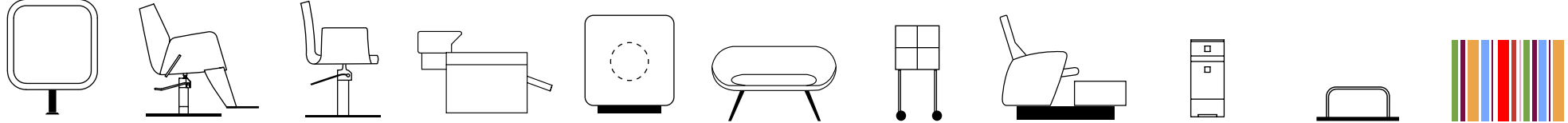

€ 55,00

Bicolore avec supplément, par place.
 Bicolore con supplemento per posto.
 Bicolor upcharge per chair.
 Bicolor con cargo adicional por plaza.
 Zweifarbig mit Preisaufschlag pro Platz.

DIAMANT

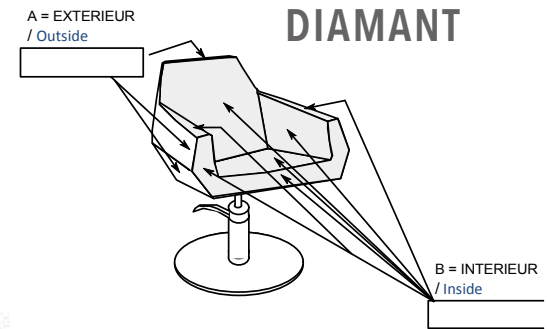

BABOU 2.0

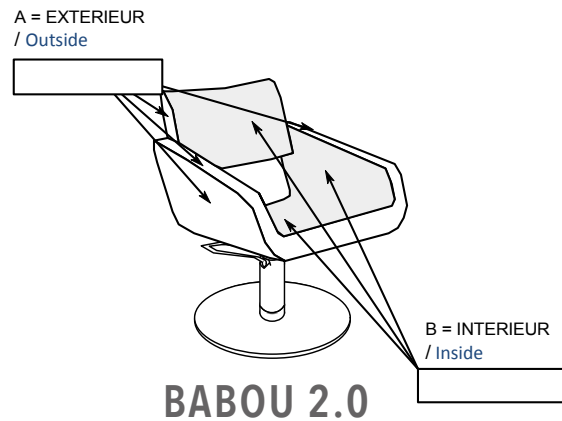

MANIA

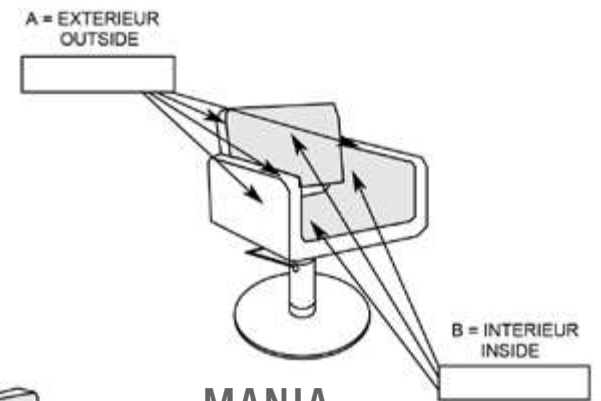

ISOKA

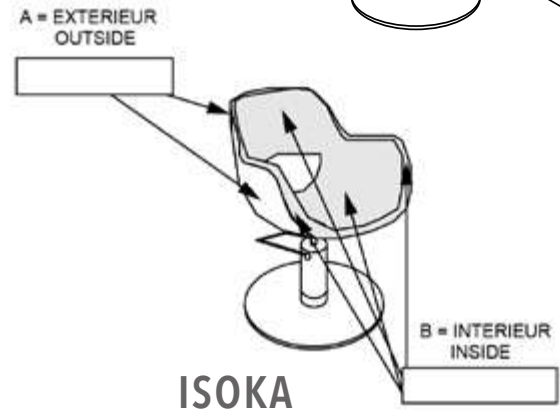

BARBIZON

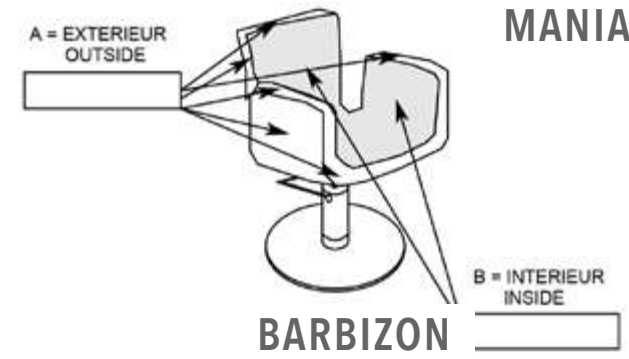

OPEN

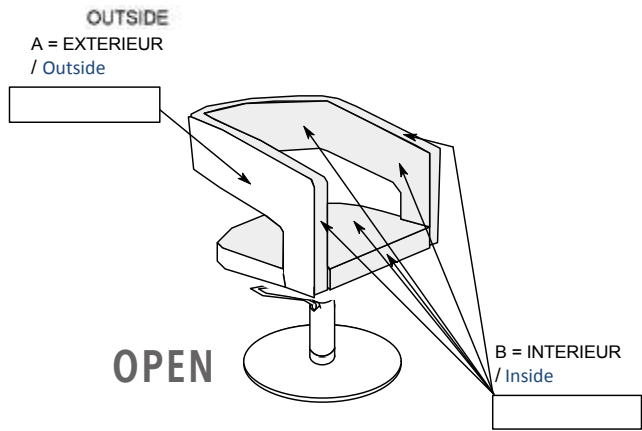

COSY

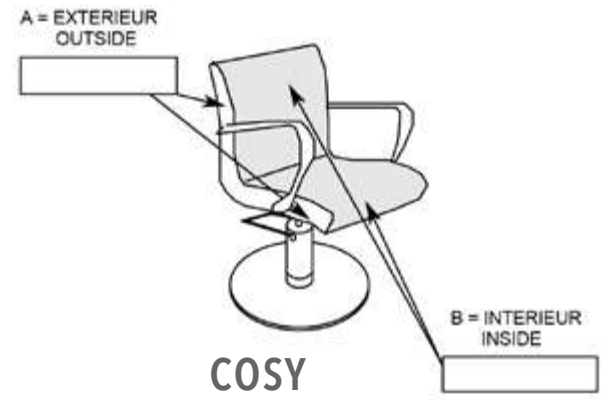

CUBE

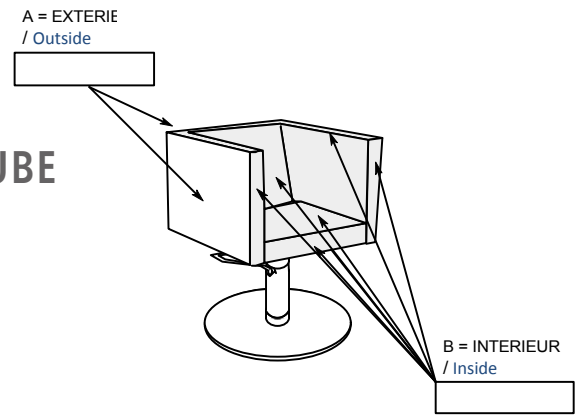

AURIAN

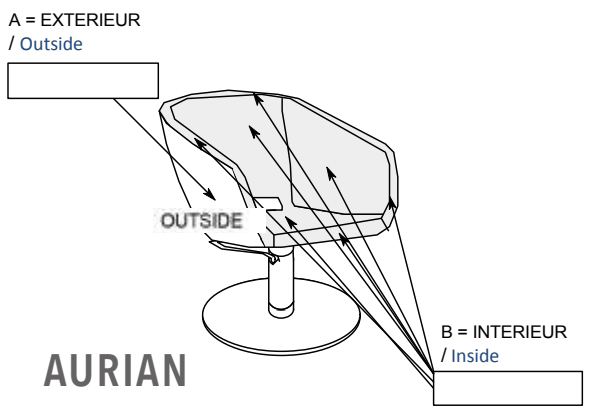

SUITE

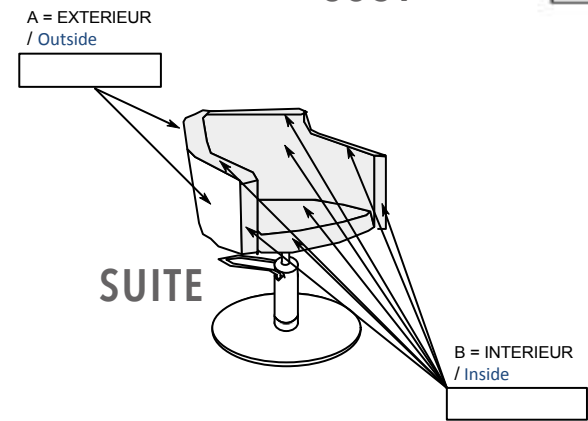

CHARME

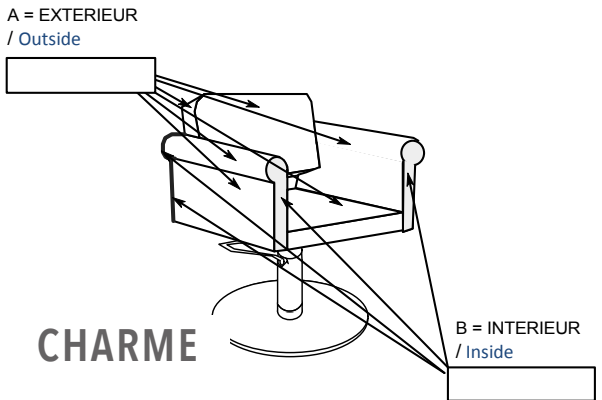

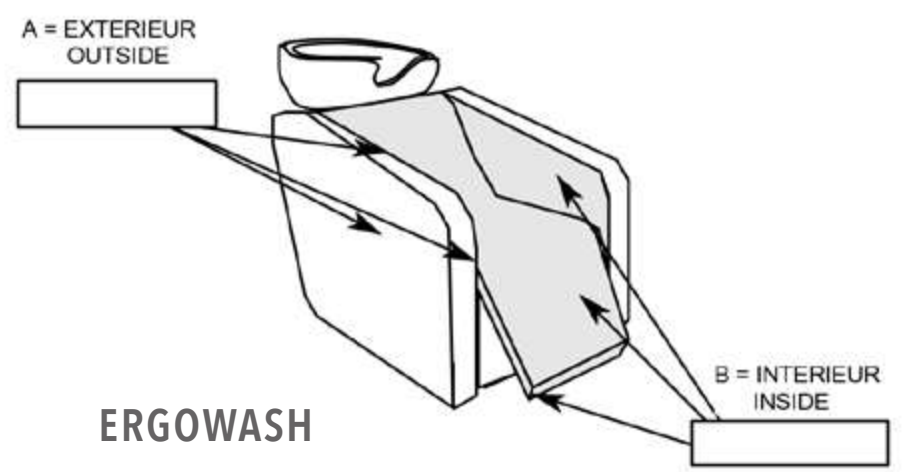
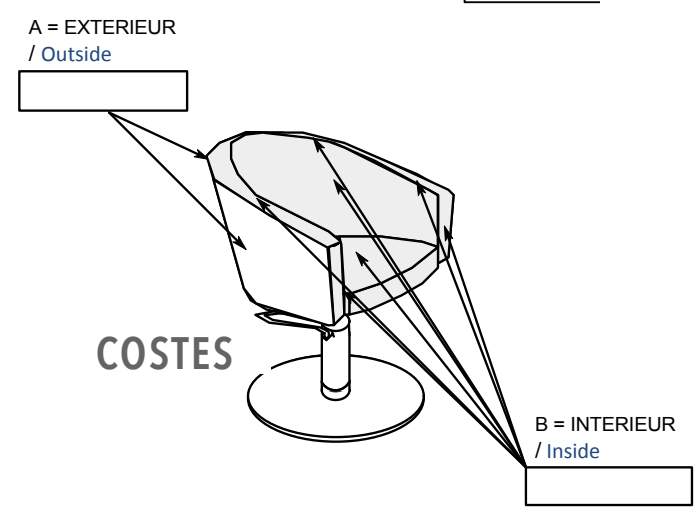
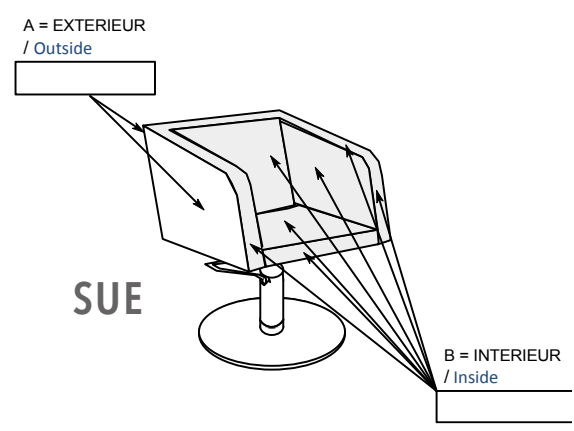
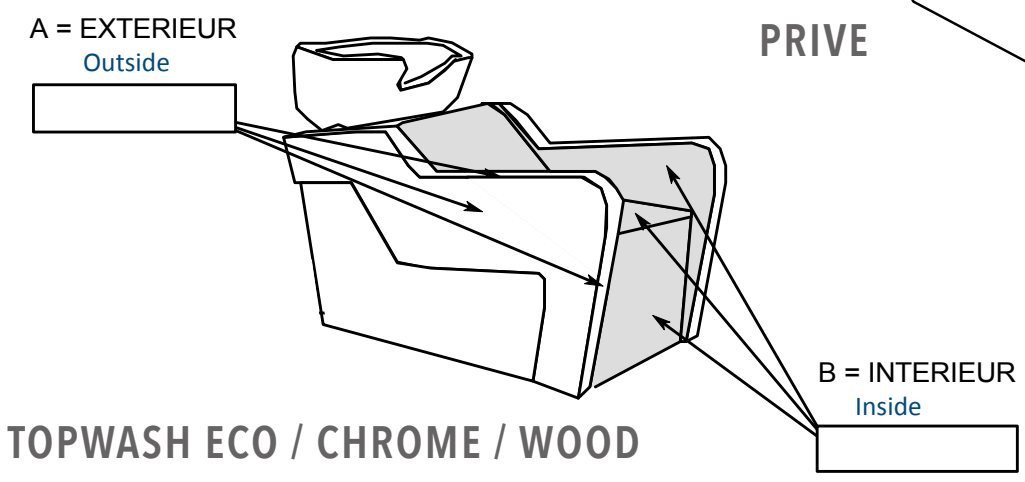
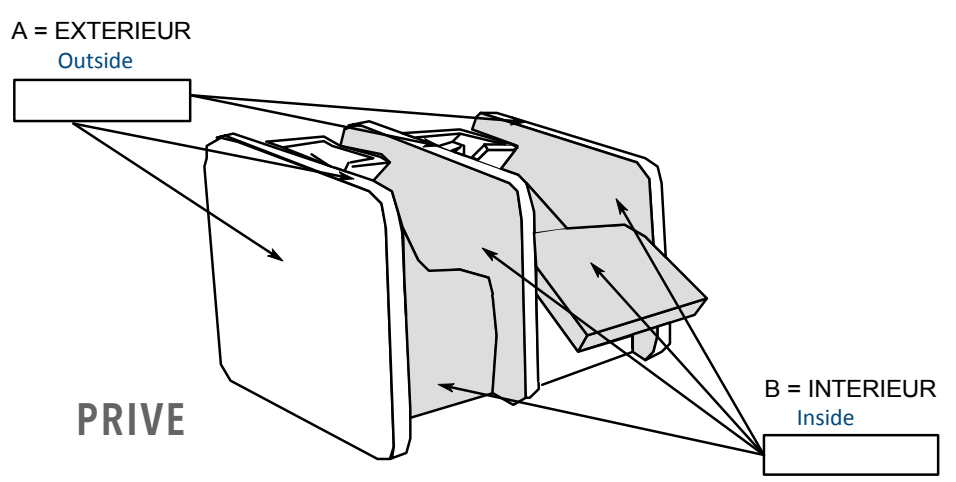
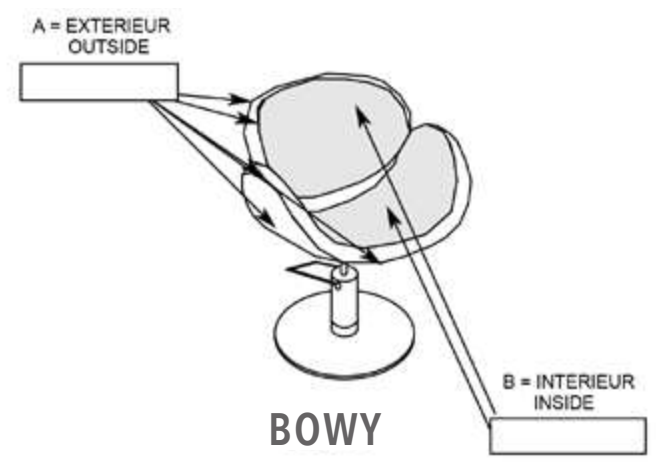
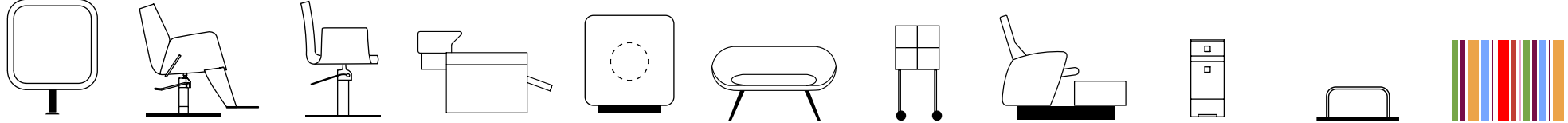

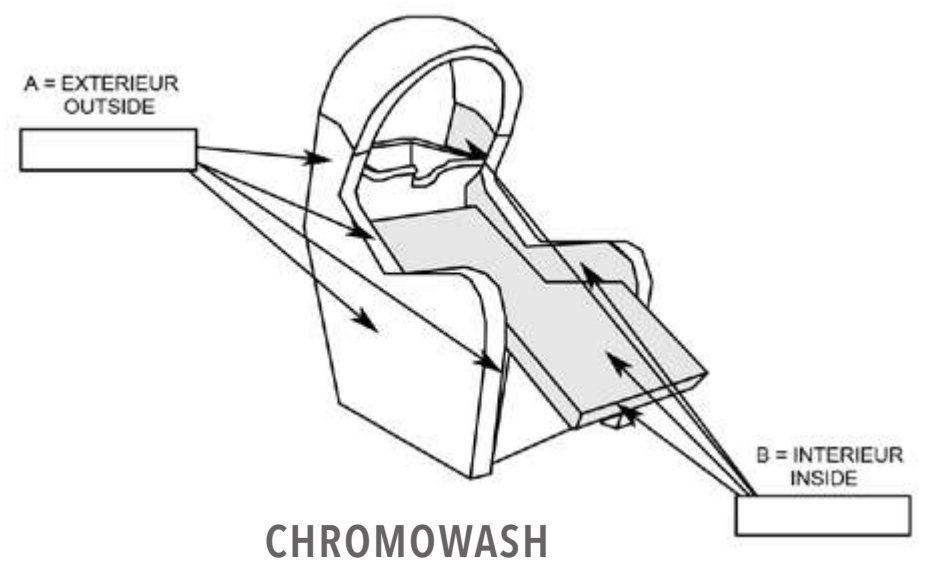
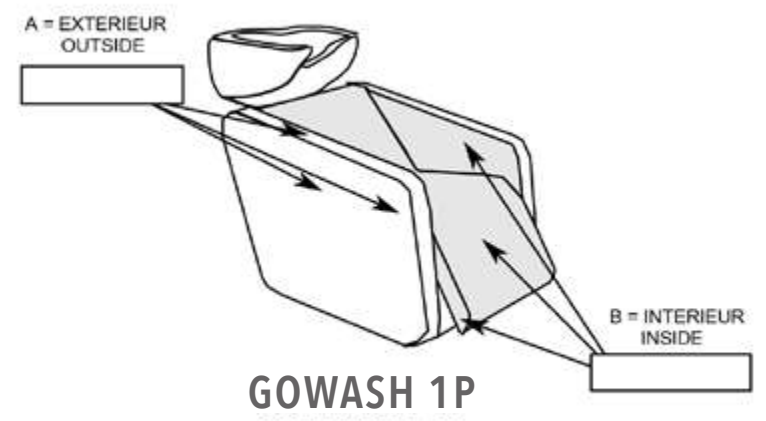
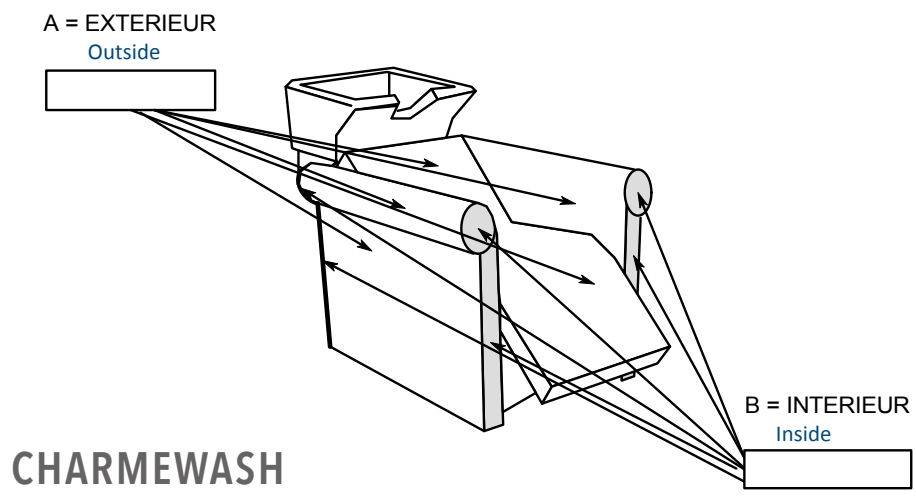
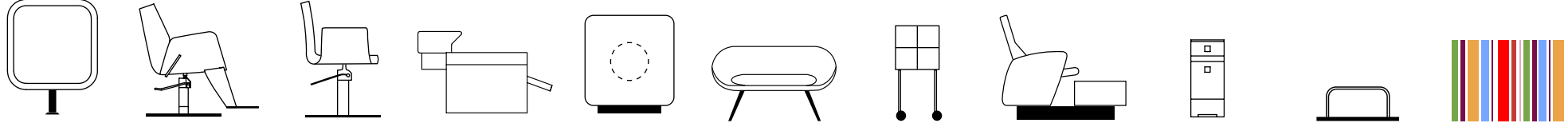

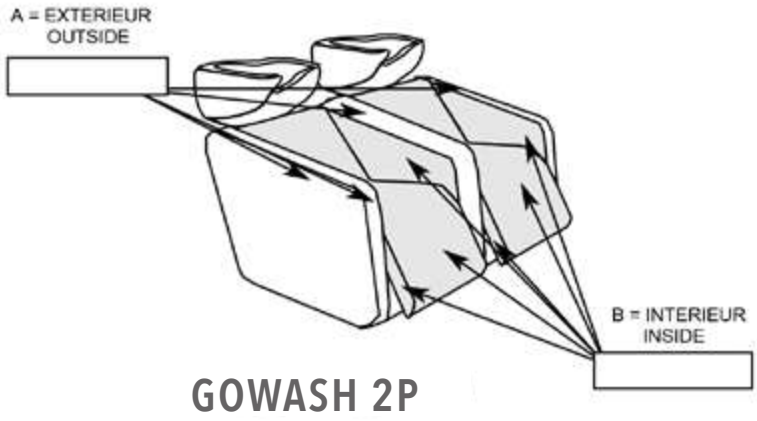
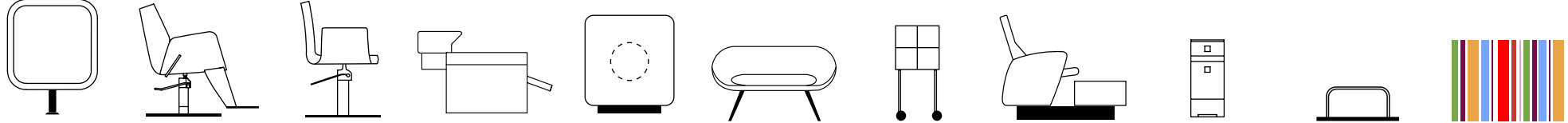

GOWASH 2P



KUAWASH

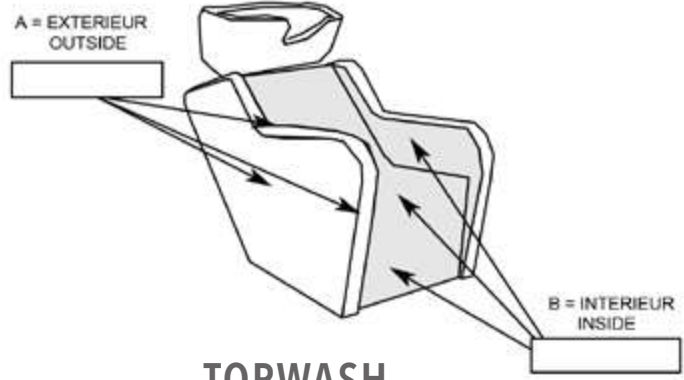

TOPWASH

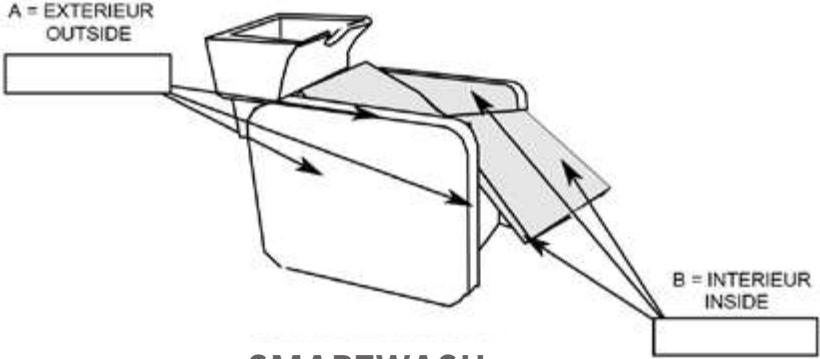

SMARTWASH

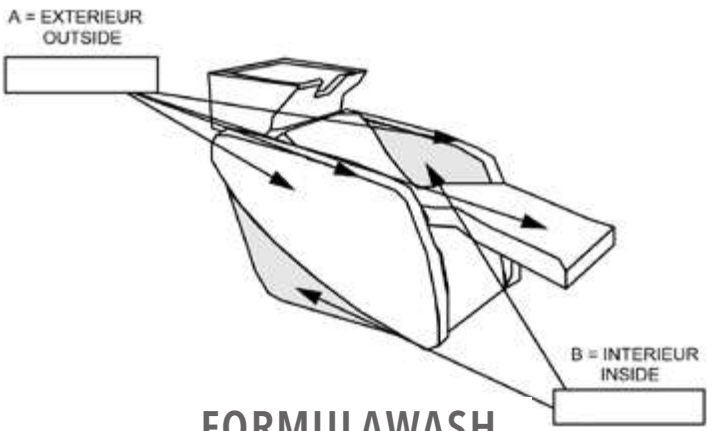

FORMULAWASH

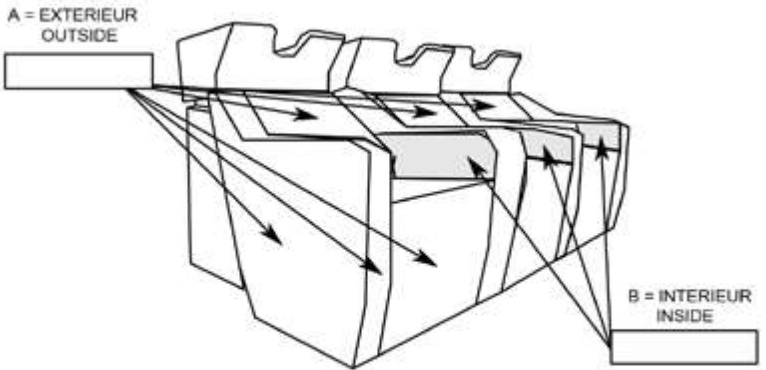

SOFA PLUS 3P

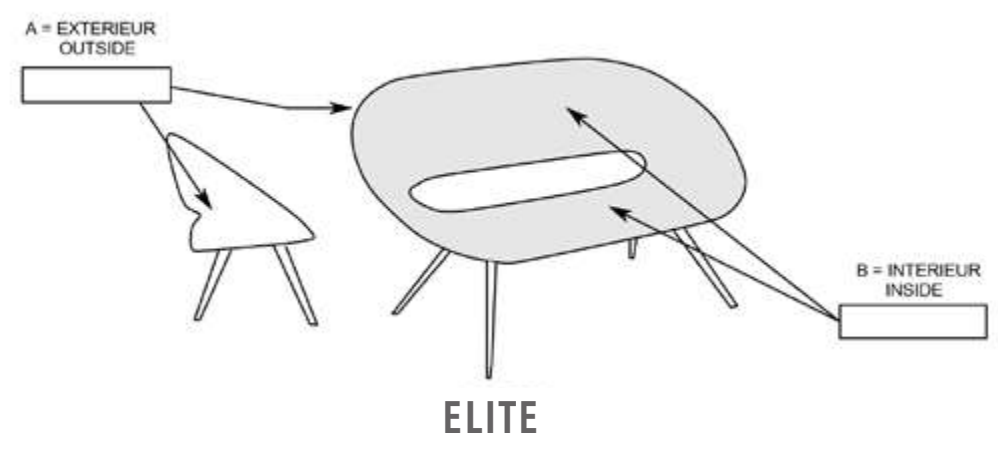
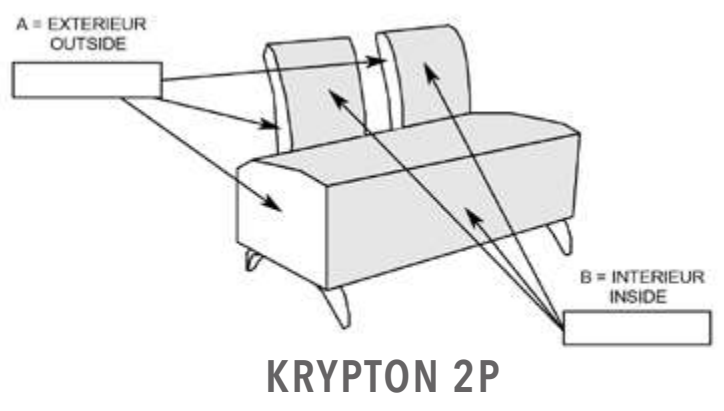
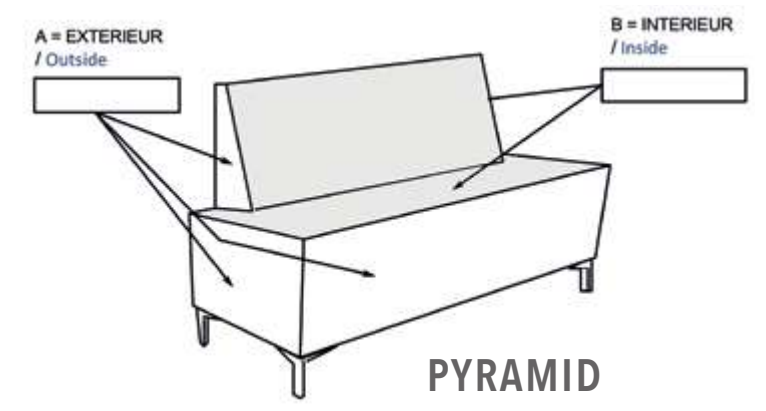
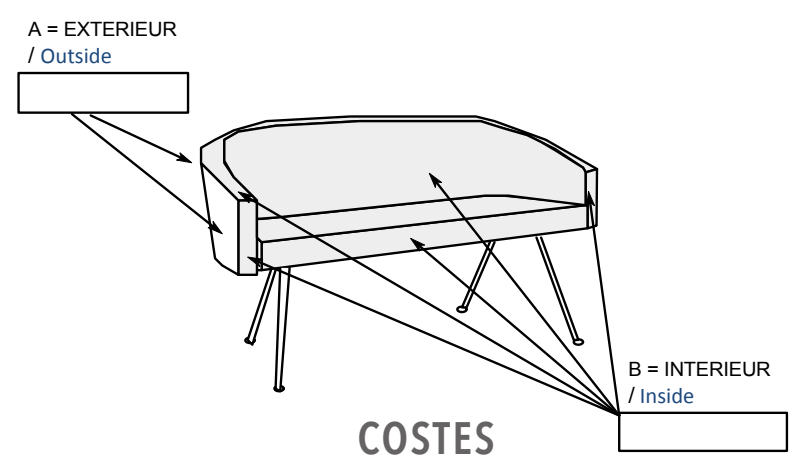
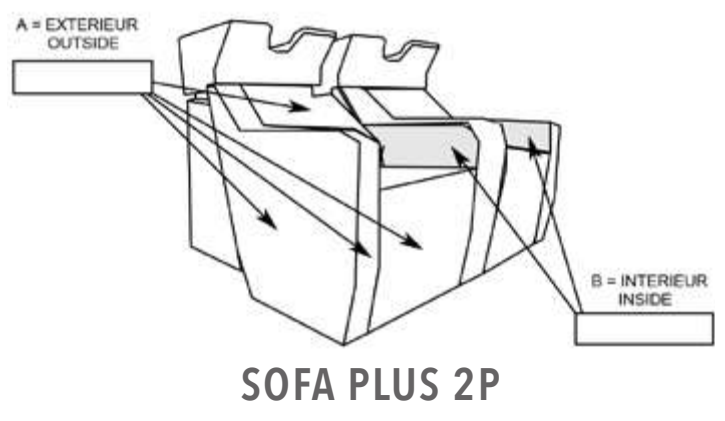
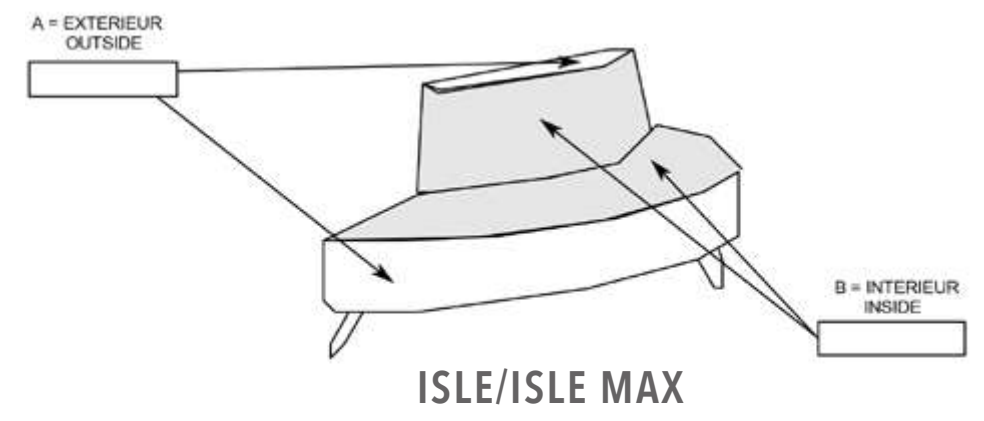
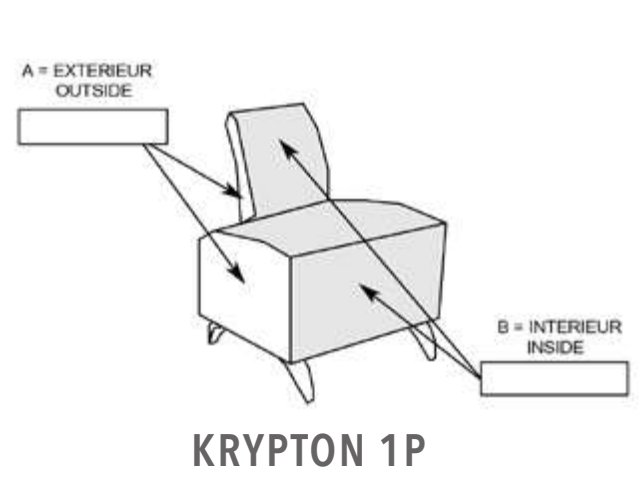
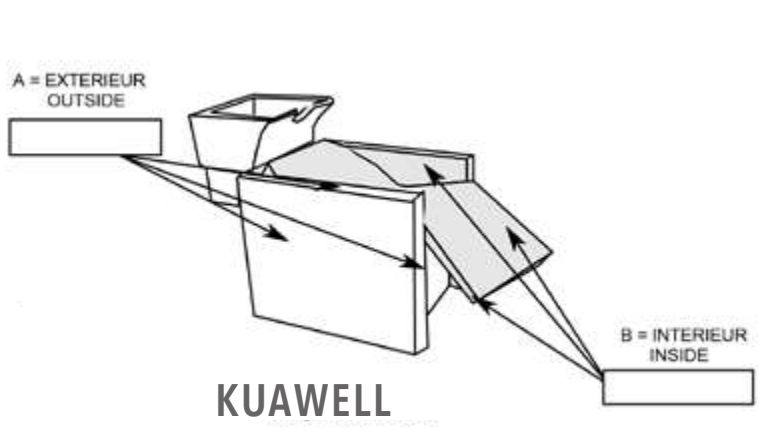
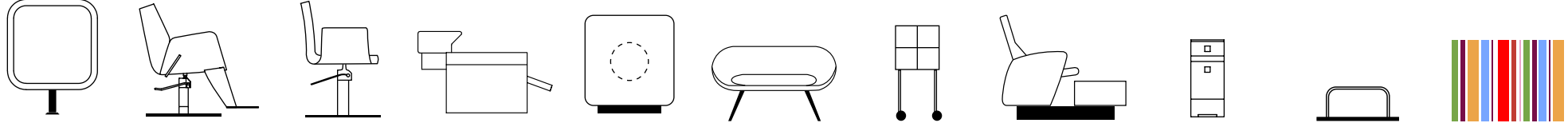

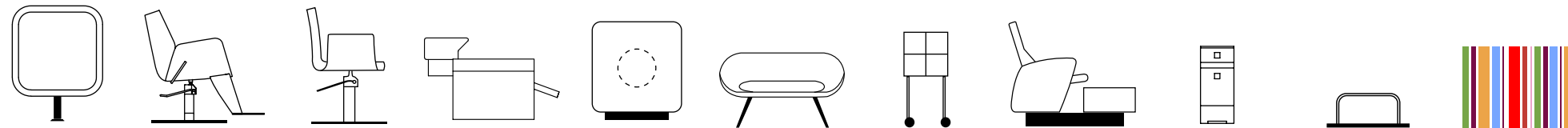

NELSON MOBILIER

CONDITIONS GENERALES DE VENTE

CONDIZIONI GENERALI DI VENDITA

STANDARD TERMS AND CONDITIONS OF SALE

CONDICIONES GENERALES DE VENTA

ALLGEMEINE VERKAUFSBEDINGUNGEN

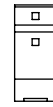
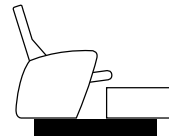
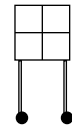
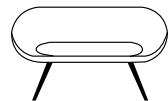
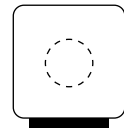
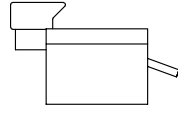
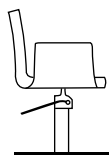
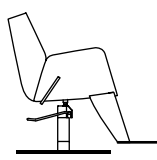
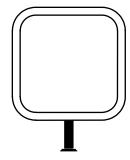

I. DISPOSITIONS GENERALES

- 1.1. Les présentes conditions générales de vente (ci-après les « CGV ») s'appliquent à toute vente de mobilier destiné aux salons de coiffure (ci-après « les Produit(s) ») par la société NELSON MOBILIER (ci-après « **NELSON MOBILIER** ») avec tout client agissant dans le cadre de son activité professionnelle (le(s) « Client(s) »).
- 1.2. Ces CGV priment sur toutes les clauses contraires figurant dans les Conditions Générales d'Achat du Client ou sur le bon de commande. En effet, les Conditions Générales d'Achat du Client ne peuvent en aucun cas prévaloir sur les présentes CGV, ces dernières constituant le socle de la relation commerciale entre **NELSON MOBILIER** et ses clients, conformément aux dispositions de l'article L.441-6 du Code du Commerce.
- 1.3. Ces CGV ainsi que les conditions tarifaires s'y rapportant sont systématiquement adressées au Client. En conséquence, la passation d'une commande implique l'acceptation entière et sans réserve du Client à ces CGV.
- 1.4. Le fait que **NELSON MOBILIER** ne se prévale pas, à un moment donné, de l'une quelconque des dispositions des présentes CGV ne peut être interprété comme valant renonciation à s'en prévaloir ultérieurement.

II. COMMANDES

- 2.1. Les commandes doivent être formalisées par écrit, au moyen d'un bon de commande dûment signé par le Client et adressé à **NELSON MOBILIER**. Les ventes ne sont parfaites qu'après acceptation expresse et écrite de la commande par **NELSON MOBILIER**.
- 2.2. Aucune annulation de commande par le Client ne sera possible après réception de la confirmation écrite de **NELSON MOBILIER**.

III. TARIFS

- 3.1. Les Produits sont fournis aux tarifs figurant sur la grille tarifaire en vigueur au jour de la passation de la commande et, le cas échéant, dans la proposition commerciale spécifique adressée au Client. Ces tarifs sont fermes et non révisables.
- 3.2. Les prix sont nets et hors taxes. Ils ne comprennent pas les emballages, le transport, les frais de douane éventuels et les assurances qui restent à la charge du Client. Le prix des emballages est indiqué dans la confirmation de la commande par **NELSON MOBILIER**. Pour les livraisons en France, le prix du transport est intégré sur facture, et calculé en fonction de la commande du Client.
- 3.3. Une éco-contribution VALDELIA est facturée au tarif légal mentionné sur la facture.

IV. PAIEMENT ET PENALITES DE RETARD

- 4.1. Les factures, y compris les factures d'acompte, sont payables à CHASSIEU, au siège de la société **NELSON MOBILIER**, dans les 30 jours maximum à compter de la date d'émission de la facture.
- 4.2. En cas de retard de paiement des sommes dues par le Client, le Client perdra tout droit aux remises, rabais, ristournes qui lui auraient été consentis, et des pénalités de retard, calculées au taux de trois fois le taux d'intérêt légal, seront automatiquement et de plein droit acquises à **NELSON MOBILIER**, sans formalité aucune ni mise en demeure préalable, et sans préjudice de toute autre action que **NELSON MOBILIER** serait en droit d'intenter, à ce titre, à l'encontre du Client. En outre, le Client sera redevable d'une indemnité forfaitaire pour frais de recouvrement fixée à 40 euros, conformément à l'article D.441-5 du Code du commerce.
- 4.3. Il est expressément convenu que toutes les sommes dues à **NELSON MOBILIER**, en vertu de tout contrat avec le Client, en principal, intérêts, frais et accessoires, deviendront immédiatement exigibles du fait du non paiement, à son échéance, de l'une quelconque des sommes dues par le Client, ou de tout manquement de ce dernier aux présentes CGV; le cas échéant, **NELSON MOBILIER** pourra exiger le paiement de toutes les sommes qui lui sont dues, et ce 30 jours après une simple notification par lettre recommandée avec demande d'avis de réception, adressée au Client et mentionnant l'intention de faire application de la présente clause, sans qu'aucune autre formalité soit nécessaire pour constater la déchéance du terme. Les paiements ou régularisations postérieurs à cette notification ne feront pas obstacle à cette exigibilité anticipée.
- 4.4. **NELSON MOBILIER** se réserve en outre le droit de suspendre ou d'annuler la livraison des commandes à venir ou en cours de la part du Client, sans préjudice des dommages et intérêts qui pourraient lui être dus.

V. RESERVE DE PROPRIETE ET TRANSFERT DES RISQUES

- 5.1. **La propriété des Produits ne sera transférée au Client qu'à compter du paiement intégral du prix et de ses accessoires et intérêts de retard, NELSON MOBILIER se réservant le droit, jusqu'alors, de reprendre possession desdits Produits. Le cas échéant, tout acompte versé par le Client restera acquis à NELSON MOBILIER à titre d'indemnisation forfaitaire, sans préjudice de toutes autres actions que notre société serait en droit d'intenter de ce fait à l'encontre du Client. Le paiement intégral s'entend de l'encaissement effectif des traites et effets de commerces ou chèques.** Le Client s'interdit de vendre ou de consentir un gage sur les Produits faisant l'objet de la réserve de propriété, à peine de résiliation de la commande. Le Client autorise d'ores et déjà **NELSON MOBILIER** à pénétrer dans ses locaux, ateliers, magasins, bureaux ou autres pour procéder à la reprise du/ou des Produits vendus non payés à l'échéance convenue, et ce, dès le lendemain de ladite échéance. Tous frais y afférents seront à la charge du débiteur défaillant.
- 5.2. **En revanche, les risques sont transférés au Client dès l'expédition des Produits, c'est-à-dire la sortie des entrepôts de NELSON MOBILIER. En conséquence, le Client s'engage à contracter toute assurance utile pour se prémunir de tous risques que peuvent encourir ou causer les Produits durant le transport et lors de leur installation.**

VI. LIVRAISON

- 6.1. Pour les livraisons hors France, les Produits sont livrés Départ Usine (ou EXW).
- 6.2. Tous nos Produits voyagent toujours aux frais, risques et périls du destinataire : il appartient donc au Client, en cas d'avaries, perte ou retard de livraison d'exercer tout recours contre le transporteur, et conformément à l'article L133-3 du Code de commerce, d'effectuer toutes les réserves nécessaires auprès du transporteur par lettre recommandée avec accusé de réception dans les 72H (non compris les jours fériés) de la réception des Produits, dont copie sera adressée simultanément à **NELSON MOBILIER**. A défaut, lesdits Produits seront considérés comme acceptés par le Client.

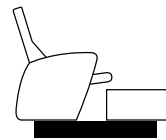
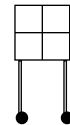
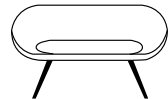
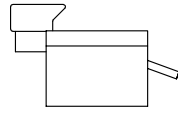
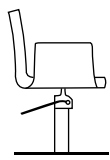
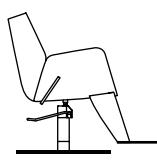
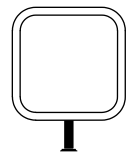

6.3. Une livraison partielle ou /et un retard de livraison ne donnent au Client ni le droit d'annuler la commande, ni celui de refuser les Produits, ni encore celui de réclamer des dommages-intérêts. Les délais de livraison ne sont donnés qu'à titre informatif et indicatif et tout retard de livraison ne peut donner lieu à aucune pénalité ou indemnité, ni motiver l'annulation de la commande.

VII. GARANTIE / RESPONSABILITE

7.1. Notre garantie se limite à la garantie légale contre les vices cachés rendant les Produits impropres à l'utilisation, et ce, pendant deux ans à partir de la date d'achat. Cette garantie est limitée au remplacement des Produits affectés d'un vice. Il appartient au Client de démontrer l'existence de ce vice.

Toute garantie est exclue en cas de mauvaise utilisation, négligence ou défaut d'entretien de la part du Client, comme en cas d'usure normale du bien ou de force majeure.

Afin de faire valoir ses droits, le Client devra, sous peine de déchéance de toute action s'y rapportant, informer **NELSON MOBILIER**, par écrit, de l'existence des vices dans un délai maximum de 3 jours à compter de leur découverte.

NELSON MOBILIER remplacera ou fera réparer les Produits ou pièces sous garantie jugés défectueux. A l'expiration de cette période de 2 années, le remplacement et le prix de toute pièce détachée demeureront à la charge du Client.

7.2. En tout état de cause, aucune réclamation ne pourra être faite concernant :

- La porosité de certains composants (socles, accoudoirs), laquelle découle des moules utilisés pour leur fabrication,
- Les taches, salissures sur les revêtements, dès lors qu'aucun revêtement simili cuir n'est anti-tache. Ceux-ci doivent être uniquement nettoyés avec de l'eau tiède et du savon,
- Les nuances de couleurs des composants, dès lors qu'ils peuvent être modifiés suite à une exposition à la lumière, et que pour des matériaux agglomérés, des vernis, des bois, il est impossible de retrouver des nuances de couleurs identiques,
- Les formes et les couleurs etc. des mosaïques, qui sont des pièces d'art uniques faites à la main et qui relèvent de choix du maître artisan en verrerie,
- Les bruits relatifs au fonctionnement des systèmes de massage. La hauteur des fauteuils, donnée à titre purement indicatif, et varie en fonction de la base choisie. La hauteur des fauteuils est établie de façon à ce que le siège soit à 48 cm environ du sol (min 46, max 51) en fonction de la base choisie.

Le Client reconnaît avoir pris connaissance des recommandations d'utilisation des Produits suivantes :

- Ne pas utiliser de produits abrasifs pour le nettoyage des éléments en aluminium.
- N'utiliser que de l'eau tiède et du savon pour nettoyer les revêtements.
- Les fauteuils peuvent être garnis avec les revêtements du client. Le cas échéant, aucune réduction de prix ne sera octroyée et notre société ne pourra pas donner de garantie équivalente aux modèles standards. NELSON MOBILIER n'accepte pas de coloris du Client à reproduire sur nos bois ou autres matières,

Ne pas soulever les fauteuils par les accoudoirs : ceci peut entraîner une entrée d'air dans la pompe. Le cas échéant, replacer la pompe dans sa position d'origine et actionner plusieurs fois la pédale afin d'expulser l'air.

7.3. **NELSON MOBILIER** n'est tenue de réparer que les dommages matériels directs causés au Client et qui résulteraient de fautes imputables à **NELSON MOBILIER** lors de l'exécution du contrat. En aucun cas, la responsabilité de **NELSON MOBILIER** ne saurait être engagée pour un montant supérieur au montant de la commande concernée.

VIII.FORCE MAJEURE

8.1. **NELSON MOBILIER** ne saurait être tenue responsable vis-à-vis du Client de la non exécution ou des retards dans l'exécution d'une obligation née des présentes CGV consécutivement à la survenance d'un cas de force majeure tel que reconnu par la jurisprudence française.

8.2. Le cas de force majeure suspend les obligations nées des présentes CGV pendant toute la durée de son existence.

IX. PROPRIETE INTELLECTUELLE / DROITS SUR LES VISUELS

9.1. **NELSON MOBILIER** est titulaire de l'ensemble des droits de propriété intellectuelle sur les Produits qu'elle commercialise. La vente des Produits ne confère aucune prérogative au Client sur les droits de propriété intellectuelle que détient **NELSON MOBILIER**.

9.2. En conséquence, le Client s'engage à n'utiliser les marques que dans le seul but de promouvoir et de revendre les Produits à l'exclusion de tout autre usage, et uniquement avec l'accord préalable écrit de **NELSON MOBILIER**.

9.3. Le Client s'engage à solliciter l'autorisation expresse de **NELSON MOBILIER** avant de diffuser des supports promotionnels concernant les Produits.

9.4. **NELSON MOBILIER** peut être amenée à transmettre au Client des visuels des Produits (plans, dessins, photographies etc.). Le Client s'engage à faire un usage particulièrement respectueux de ces visuels en accord avec l'image de marque de **NELSON MOBILIER**. En aucun cas, ce droit d'usage n'emporte pour le Client le droit de modifier ou d'adapter ces visuels, sans l'accord préalable écrit de **NELSON MOBILIER**.

X. LANGUE DU CONTRAT

Les présentes CGV sont rédigées en langue française. Dans le cas où elles seraient traduites en une ou plusieurs langues, seul le texte français ferait foi en cas de litige.

XI. DROIT APPLICABLE / JURIDICTION COMPETENTE

11.1. De convention expresse entre les Parties, les présentes Conditions Générales de Vente et les commandes qui en découlent sont régies par le droit français.

11.2. Tout litige né entre **NELSON MOBILIER** et ses Clients à l'occasion de la commande de Produits sera soumis exclusivement au Tribunal de Commerce de LYON.

Numéro d'enregistrement en application de l'article L.541-10 du code de l'environnement : FR014096

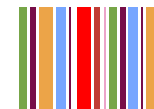
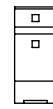
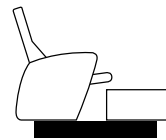
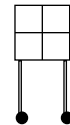
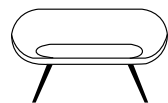
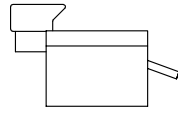
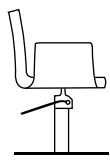
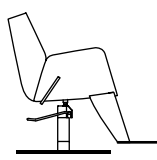
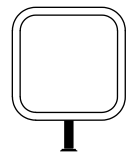

I. DISPOSIZIONI GENERALI

- 1.1. Le presenti condizioni generali di vendita (di seguito “CGV”) si applicano a tutte le vendite di mobili destinati a saloni di parrucchieri (di seguito “il Prodotto”) da parte di NELSON MOBILIER (di seguito “**NELSON MOBILIER**”) a beneficio di qualsiasi cliente che opera nell’ambito della propria attività professionale (“il Cliente”).
- 1.2. Tali CGV prevalgono su eventuali clausole contrarie nelle Condizioni Generali di Acquisto del Cliente o nel buono d’ordine. In effetti, le Condizioni Generali di Acquisto del Cliente non possono in alcun caso prevalere sulle presenti CGV, in quanto queste ultime costituiscono la base del rapporto commerciale tra **NELSON MOBILIER** ed i suoi clienti, in conformità con le disposizioni di cui all’articolo L.441-6 del Codice del Commercio.
- 1.3. Le CGV e le condizioni tariffarie ad esse relative vengono inviate sistematicamente al Cliente. Di conseguenza, l’invio di un ordine implica l’accettazione completa ed incondizionata delle CGV da parte del Cliente.
- 1.4. Il fatto che **NELSON MOBILIER** non rivendichi, in un determinato momento, una qualsiasi disposizione delle presenti CGV non può essere interpretato come una rinuncia ad una successiva rivendicazione.

II. ORDINI

- 2.1. Gli ordini devono essere formalizzati per iscritto, con un buono d’ordine debitamente firmato dal Cliente ed inviato a **NELSON MOBILIER**. Le vendite saranno perfezionate solo dopo l’accettazione espressa e scritta dell’ordine da parte di **NELSON MOBILIER**.
- 2.2. Dopo la conferma scritta dell’ordine da parte di **NELSON MOBILIER** il Cliente non potrà in alcun modo annullare l’ordine.

III. PREZZI

- 3.1. I Prodotti sono forniti ai prezzi indicati sul tariffario in vigore alla data di inserimento dell’ordine e, se del caso, nella proposta commerciale specifica inviata al Cliente. Questi prezzi sono fissi e non soggetti a revisione.
- 3.2. I prezzi si intendono al netto delle imposte. Essi non includono l’imballaggio, il trasporto, gli eventuali oneri doganali e l’assicurazione che restano a carico del Cliente. Il prezzo dell’imballaggio è indicato nella conferma dell’ordine di **NELSON MOBILIER**. Per le consegne in Francia, il costo del trasporto è compreso nella fattura e calcolato in funzione dell’ordine del Cliente.
- 3.3. Viene addebitato secondo il corrispettivo stabilito per legge menzionato in fattura un eco-contributo VALDELIA.

IV. PAGAMENTO E PENALITÀ DI MORA

- 4.1. Le fatture, compreso quelle di acconto, possono essere pagate a CHASSIEU, presso la sede di **NELSON MOBILIER**, entro 30 giorni al massimo a partire dalla data di emissione della fattura.
- 4.2. In caso di ritardo nel pagamento delle somme dovute da parte del Cliente, quest’ultimo perderà ogni diritto a riduzioni, sconti, abbuoni che gli sarebbe stato concesso. Verranno quindi applicate penalità di mora calcolate a tre volte il tasso di interesse legale da parte di **NELSON MOBILIER**, senza preavviso o formalità, e senza pregiudizio di qualsiasi altra azione che **NELSON MOBILIER** avrebbe diritto ad intentare nei confronti del Cliente. Inoltre, il Cliente dovrà versare un’indennità forfettaria per le spese di recupero pari a 40 euro, ai sensi dell’articolo D.441-5 del Codice del Commercio.
- 4.3. È espressamente convenuto che tutte le somme dovute a **NELSON MOBILIER**, in virtù di qualsiasi contratto con il Cliente, per il debito principale, gli interessi, le spese e gli accessori, diventeranno immediatamente esigibili a causa di un mancato pagamento alla scadenza prevista di una qualunque somma dovuta dal Cliente, o qualsiasi violazione di quest’ultimo delle presenti CGV; se del caso, **NELSON MOBILIER** potrà esigere il pagamento di tutte le somme dovute, 30 giorni dopo una semplice comunicazione a mezzo lettera raccomandata con ricevuta di ritorno indirizzata al Cliente, in cui si menziona l’intenzione di applicare la presente clausola, senza che sia necessaria un’altra formalità per constatare la scadenza del termine. I pagamenti o le regolarizzazioni successive alla suddetta comunicazione non costituiranno un ostacolo all’esigibilità anticipata.
- 4.4. **NELSON MOBILIER** si riserva inoltre il diritto di sospendere o annullare la consegna degli ordini futuri o in corso del Cliente, fatti salvi danni e interessi che potrebbero essere dovuti.

V. RISERVA DI PROPRIETÀ E TRASFERIMENTO DEI RISCHI

- 5.1. **La proprietà dei Prodotti verrà trasferita al Cliente solo a partire dal pagamento integrale del prezzo e dei suoi accessori e interessi di mora; per questo NELSON MOBILIER si riserva, fino a quel momento, di rientrare in possesso di tali Prodotti. Se del caso, l’acconto versato dal Cliente sarà trattenuto da NELSON MOBILIER a titolo di indennità forfettaria, fatte salve le altre azioni che la nostra società avrebbe diritto ad avviare in tale contesto nei confronti del Cliente. Il pagamento integrale si intende con l’incasso effettivo delle quote e degli effetti commerciali o assegni.**

Il Cliente si impegna a non vendere o consentire pegni sui Prodotti soggetti a riserva di proprietà, pena il recesso dell’ordine.

Il Cliente autorizza sin da ora **NELSON MOBILIER** ad entrare nei locali, laboratori, negozi, uffici o altro per procedere al ritiro dei Prodotti venduti e non pagati alla data di scadenza, a partire dal giorno successivo a tale scadenza. Tutti i relativi costi saranno a carico del debitore inadempiente.

- 5.2. **Per contro, i rischi verranno trasferiti al Cliente al momento della spedizione dei Prodotti, vale a dire all’uscita dai depositi di NELSON MOBILIER. Di conseguenza, il Cliente si impegna a stipulare i contratti assicurativi necessari per premunirsi contro i rischi che possono correre o causare i Prodotti durante il trasporto e la relativa installazione.**

VI. CONSEGNA

- 6.1. Per le consegne al di fuori della Francia, i Prodotti vengono consegnati Franco Fabbrica (o EXW).
- 6.2. I nostri Prodotti viaggiano sempre a spese, rischio e pericolo del destinatario: è quindi responsabilità del Cliente, in caso di avarie, perdite o ritardi nella consegna, presentare ricorso nei confronti del vettore, e, in conformità con l’articolo L133-3 del Codice del Commercio, dichiarare tutte le riserve necessarie presso il vettore mediante lettera raccomandata con avviso di ricevimento entro le 72 ore (escluso festivi) dalla ricezione dei Prodotti, la cui copia sarà inviata simultaneamente a **NELSON MOBILIER**. In caso contrario, i suddetti Prodotti saranno considerati accettati dal Cliente.

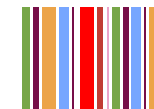
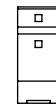
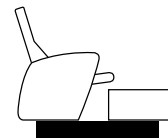
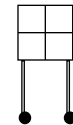
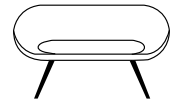
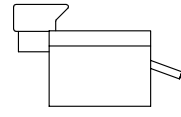
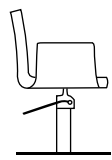
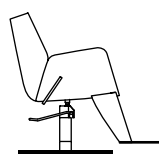
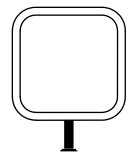

6.3. Una consegna parziale e/o un ritardo nella consegna non conferiranno al Cliente il diritto di annullare l'ordine, né di rifiutare i Prodotti o chiedere un risarcimento. I tempi di consegna sono forniti a titolo informativo ed indicativo e ed eventuali ritardi nella consegna non danno luogo ad alcuna penalità o indennità, né costituiscono motivo per annullare l'ordine.

VII. GARANZIA/RESPONSABILITÀ

7.1. La nostra garanzia è limitata alla garanzia legale contro i difetti nascosti che rendono inutilizzabili i Prodotti, per due anni dalla data di acquisto. Questa garanzia è limitata alla sostituzione dei Prodotti viziati da un difetto. Spetta al Cliente dimostrare l'esistenza di tale difetto.

La garanzia è esclusa in caso di uso improprio, negligenza, o mancanza di manutenzione da parte del Cliente, come in caso di normale usura del bene o di forza maggiore.

Per far valere i propri diritti, il Cliente dovrà, a pena di decadenza di ogni relativa azione, informare, per iscritto, **NELSON MOBILIER** dell'esistenza di difetti entro un massimo di 3 giorni dalla scoperta.

NELSON MOBILIER andrà a sostituire o riparare i Prodotti o le parti in garanzia considerati difettosi. Al termine di questo periodo di 2 anni, la sostituzione e il prezzo di qualsiasi pezzo di ricambio rimarranno a carico del Cliente.

7.2. In ogni caso, non potrà essere presentato alcun reclamo riguardante:

- La porosità di alcuni componenti (basi, braccioli) che deriva dagli stampi impiegati per la fabbricazione,
- Le macchie, le incrostazioni sui rivestimenti, dal momento che nessun rivestimento in similpelle è antimacchia. Queste devono essere pulite solo con acqua tiepida e sapone,
- Le tonalità dei colori dei componenti, in quanto potrebbero essere modificate a causa dell'esposizione alla luce, e per i materiali agglomerati, le vernici, il legno, è impossibile ritrovare sfumature di colori identiche,
- Le forme, i colori, ecc. dei mosaici, che sono pezzi d'arte unici fatti a mano e che rientrano nella scelta dell'artigiano vetraio,
- I rumori relativi al funzionamento dei sistemi di massaggio,

L'altezza delle poltrone, fornita unicamente a titolo indicativo, varia a seconda della base selezionata. L'altezza delle poltrone è impostata in modo che la seduta sia a circa 48 cm da terra (min 46, max 51) a seconda della base selezionata.

Il Cliente conferma di aver preso visione delle raccomandazioni d'uso dei seguenti Prodotti:

- Non utilizzare abrasivi per la pulizia degli elementi in alluminio,
- Utilizzare solo acqua tiepida e sapone per pulire i rivestimenti,
- Le poltrone possono essere rifinite con i rivestimenti del cliente. Se del caso, non sarà concessa alcuna riduzione sul prezzo e la nostra società non fornirà garanzie equivalenti ai modelli standard. **NELSON MOBILIER** non accetta i colori del Cliente da riprodurre sul nostro legno o altri materiali,

Non sollevare le poltrone dai braccioli: questo può causare l'ingresso di aria nella pompa. Se del caso, sostituire la pompa nella sua posizione originale e azionare il pedale diverse volte per espellere l'aria.

7.3. **NELSON MOBILIER** è obbligata a risarcire i danni materiali diretti causati al Cliente e risultanti da difetti imputabili a **NELSON MOBILIER** durante l'esecuzione del contratto. In nessun caso potrà essere vincolata la responsabilità di **NELSON MOBILIER** per importi superiori all'importo dell'ordine interessato.

VIII. FORZA MAGGIORE

8.1. **NELSON MOBILIER** non potrà essere ritenuta responsabile nei confronti del Cliente per la mancata esecuzione o ritardi nell'esecuzione di un obbligo derivante dalle presenti CGV in seguito al verificarsi di un evento di forza maggiore riconosciuto dalla giurisprudenza francese.

8.2. L'evento di forza maggiore sospende gli obblighi derivanti dalle presenti CGV per tutta la durata della sua esistenza.

IX. PROPRIETÀ INTELLETTUALE/DIRITTI SULLE IMMAGINI

9.1. **NELSON MOBILIER** detiene tutti i diritti di proprietà intellettuale sui Prodotti che commercializza. La vendita dei Prodotti non conferisce alcun privilegio al Cliente sui diritti di proprietà intellettuale detenuti da **NELSON MOBILIER**.

9.2. Di conseguenza, il Cliente si impegna ad utilizzare i marchi con l'unico scopo di promuovere e rivendere i Prodotti ad esclusione di qualsiasi altro utilizzo, e soltanto con il previo consenso scritto di **NELSON MOBILIER**.

9.3. Il Cliente si impegna a cercare il consenso esplicito di **NELSON MOBILIER** prima di distribuire materiale promozionale per i Prodotti.

9.4. **NELSON MOBILIER** può ricevere la richiesta di trasmettere al Cliente le immagini dei Prodotti (piante, disegni, fotografie, ecc). Il Cliente si impegna a fare un utilizzo particolarmente rispettoso di questi elementi visivi con l'immagine del marchio di **NELSON MOBILIER**. In ogni caso, questo diritto di utilizzo non comporta per il Cliente il diritto di modificare o adattare queste immagini, senza il previo consenso scritto di **NELSON MOBILIER**.

X. LINGUA DEL CONTRATTO

Le presenti CGV sono redatte in lingua francese. Nel caso in cui si siano tradotte in una o più lingue, prevarrà il testo francese in caso di controversia.

XI. NORMATIVA APPLICABILE/GIURISDIZIONE COMPETENTE

11.1. In accordo esplicito tra le Parti, le presenti Condizioni Generali di Vendita e gli ordini che ne derivano sono disciplinati dalla normativa francese.

11.2. Qualsiasi controversia che dovesse insorgere tra **NELSON MOBILIER** ed i suoi Clienti in relazione all'ordine di Prodotti saranno sottoposte esclusivamente al Tribunale del Commercio di Lione.

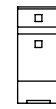
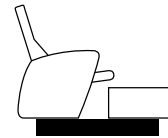
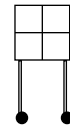
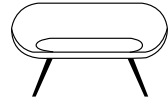
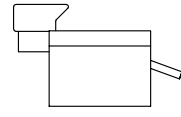
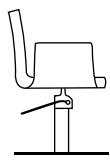
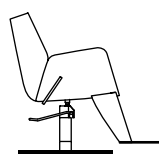
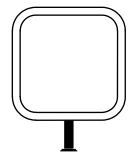

I. GENERAL PROVISIONS

- 1.1. The present standard terms and conditions of sale (hereafter referred to as "STCS") apply to all sales of **NELSON MOBILIER** destined to hairdresser saloons (hereafter referred to as "the Product(s)") to any client acting within its professional activity (hereafter referred to as "the Client(s)").
- 1.2. These STCS prevail over any contrary clause included in the Standard Terms and Conditions of Purchase of the Clients or on the purchase order. Indeed, the Standard Terms and Conditions of Purchase can never prevail on the present STCS, since these STCS constitute the base of the commercial relationship between **NELSON MOBILIER** and its clients, pursuant to the provisions of article L.441-6 of the French Commercial Code.
- 1.3. These STCS and the applicable pricing conditions are systematically sent to the Client. Consequently, the performance of an order implies a full and unreserved acceptance by the Client of these STSC.
- 1.4. The fact that **NELSON MOBILIER** may not, at a specific moment in time, refer to or invoke any given term of the present STSC may in no way be interpreted as a renunciation to invoke the said term subsequently.

II. ORDERS

- 2.1. The orders must be formalized in writing, by a purchase order dully signed by the Client and sent to **NELSON MOBILIER**. The sales will become perfect only after a written and express acceptance of the order has been sent by **NELSON MOBILIER**.
- 2.2. No cancellation of the order by the Client will be possible after reception of the said written acceptance from **NELSON MOBILIER**.

III. PRICES

- 3.1. The Products are sold at the prices listed on the pricing conditions applicable on the day of the issuance of the order and, as the case may be, in the specific commercial proposal sent to the Client. These prices are fixed and non negotiable.
- 3.2. The prices are net and tax excluded. They do not include packaging, transportation, possible customs fees and insurances which remain at the expense of the Client. The price of the packaging is indicated in the order confirmation sent by **NELSON MOBILIER**. For deliveries to France, the price of transportation is included on the invoice and calculated on the basis of the purchase performed by the Client.
- 3.3. An eco-contribution VALDELIA is invoiced at the legal amount as indicated on the invoice.

IV. PAYMENT AND LATE PAYMENT PENALTIES

- 4.1. The invoices, including the advance payment invoices, are to be paid at CHASSIEU, at the registered office of **NELSON MOBILIER**, within a maximum period of thirty days starting from the date of issuance of the said invoice.
- 4.2. In the event of a late payment of any sums owed by the Client, the Client will lose any right to discounts, rebates or reductions it may have been entitled to and late payment penalties, calculated on the basis of three times the legal interest rate, shall be automatically owed to NELSON MOBILIER, without any prior formality or letter of notice, and without prejudice of any other action that NELSON IMMOBILIER may be entitled to initiate against the Client on this basis. In addition, the Client shall owe a fixed penalty of 40 euros corresponding to the recovery fees, pursuant to article D.441-5 of the French Commercial code.
- 4.3. It is expressly agreed that all sums owed to **NELSON MOBILIER**, pursuant to any contract concluded with the Client, in principal, interests, costs and accessories, shall become immediately due further to the non-payment, after expiration of the term of payment, of any of the sums owed by the Client or of any breach of the Client to the present STSC. When appropriate, **NELSON MOBILIER** may request the payment of any sums owed to it 30 days after having sent a letter of notice with acknowledgement of receipt indicating its intention to apply the present clause, without that any other formality shall be necessary to acknowledge the forfeiture of the term. The payments or regularisations made subsequently to the said notification shall not prevent this anticipated date of payment.
- 4.4. In addition **NELSON MOBILIER** reserves the right to suspend or cancel the delivery of ongoing orders and/or orders to come performed by the Client, without prejudice of the damages it may be owed.

V. RESERVATION OF OWNERSHIP AND TRANSFER OF RISKS

- 5.1. **The ownership of Products will only be transferred to the Client from the moment of the full payment of the price, of its accessories and of late payment interests. Until then, NELSON MOBILIER reserves the right to recover possession of the said Products. When appropriate, any advance payment will be retained by NELSON MOBILIER as a fixed compensation, without prejudice of any other actions that NELSON MOBILIER may be entitled to initiate against the Client. Full payment is understood as the effective collection of bank drafts, commercial papers or checks.**
The Client undertakes not to sell or provide a security or guarantee on the Products subject to a reservation of ownership, under penalty of a termination of the order.
 The Client authorises **NELSON MOBILIER** to penetrate its premises, workshops, stores, offices and other to proceed to the recovery of any sold Product(s) that remains, even in part, unpaid at the expiration of the payment term, starting from the day following the said term. Any costs resulting from such recovery shall be at the expense of the debtor.
- 5.2. However, the risks are transferred to the Client from the moment of the expedition of the Products, i.e. as soon as it/they exit the **NELSON MOBILIER** warehouses. Consequently, the Client undertakes to subscribe any necessary insurance **to prevent any risks the Products may be subject to or may cause during their transportation and installation.**

VI. DELIVERY

- 6.1. For deliveries outside of France, the Products will be delivered Ex Works (or EXW).
- 6.2. All our Products always travel at the expense and risks of their recipient: it is therefore incumbent on the Client, in the event of damage, loss or delivery delay, to initiate any action against the carrier, and pursuant to article L133-3 of the French Commercial Code, to adress any necessary reservation to the carrier by registered letter with acknowledgement of receipt within 72 hours (holidays excluded) from the reception of the Products, copy of which shall simultaneously sent to **NELSON MOBILIER**. Failure to do so will result in the Products being deemed as accepted by the Client.

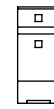
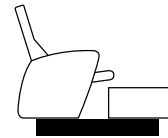
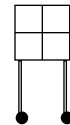
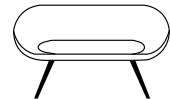
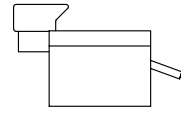
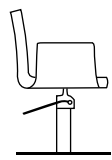
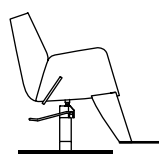
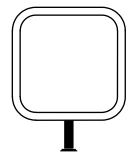

6.3. A part delivery and/or a delay in the delivery do not entitle the Client to cancel the order, nor to refuse the Products, nor to claim compensation or damages.
The delivery delays are given exclusively for information and indication purposes and no delivery delay may result in any penalty or compensation, nor justify the cancelation of the order.

VII. WARRANTY / LIABILITY

7.1. Our warranty is limited to the legal guarantee against hidden defects rendering the Product unfit for the use for which it is intended which applies for a period of two years from its date of purchase. This guarantee is limited to the replacement of the Products suffering from a defect. It is incumbent on the Client to prove the existence of such defect.
Any warranty is cancelled in the case of improper use, negligence or lack of maintenance from the Client, as in the case of normal wear of the Products or force majeure.
In order to assert its rights, the Client undertakes, under penalty of forfeiting any right to act on this basis, to inform **NELSON MOBILIER**, in writing, of the existence of the defect(s), within a maximum delay of 3 days after its (their) discovery.
NELSON MOBILIER will replace or have repaired the Products or parts under guarantee deemed defective. At the expiry of the two year warranty period, the replacement and the price of any spare part will be at the expense of the Client.

7.2. In any event, no claim may be performed regarding:
The porosity of certain components (base frames, armrests), which results from the moulds used for their fabrication,
The stains on the coatings, since no imitation leather coating is anti-stain. They must exclusively be cleaned with lukewarm water and soap,
The nuances of colours of the components, given they may be modified further to exposition to light, and that for agglomerate materials, varnishes and woods, it is impossible to recover identical colour nuances,
The forms and the colours etc. of the mosaics, which are unique handcrafted pieces of art and result from the choice of the glasswork master craftsman,
The noises resulting from the functioning of the massage systems,
The height of the armchairs, given exclusively for information purposes, and which varies depending on the base frame chosen. The height of armchairs is established with the purpose that the seat lay approximately 48 cm above the ground (min 46, max 51) depending on the base frame chosen.
The Client acknowledges it has been informed of the following Products use recommendations:
Not to use abrasive Products for the cleaning of elements made of aluminium,
To use only lukewarm water and soap to clean the coatings,
The armchairs may be coated with the coatings of the Client. In this instance, no price reduction may be granted and **NELSON MOBILIER** will be unable to provide guarantees equivalent to the standard models. **NELSON MOBILIER** does not accept any colour or shade from the Client to be applied on its woods or other materials,
Not to raise the armchairs by the armrests: this may cause an entry of air in the pump. In that case, replace the pump in its initial position and activate the pedal several times in order to eject the air.

7.3. **NELSON MOBILIER** shall exclusively compensate direct material damages caused to the Client and which would result directly from breaches that may be attributed to **NELSON MOBILIER** during the performance of the contract. In no event, the liability of **NELSON MOBILIER can be pursued** for an amount exceeding the amount of the order in question.

VIII. FORCE MAJEURE

8.1. **NELSON MOBILIER** cannot be held liable towards the Client for the non performance or the delay in the performance of any obligation arising from the present STCS following the occurrence of a “*cas de force majeure*” such as defined by the French courts.
8.2. The occurrence of a “*cas de force majeure*” suspends the obligations arising from the present STCS for the entire period of its existence.

IX. INTELLECTUAL PROPERTY / RIGHTS ON THE VISUALS

9.1. **NELSON MOBILIER** is the sole owner of the intellectual property rights on the Products it commercializes. The sale of the Products does not award to the Client any prerogative on the intellectual property rights held by **NELSON MOBILIER**.
9.2. Consequently, the Client undertakes only to use the brands with the aim to promote and resell the Products excluding any other use, and exclusively after prior written agreement has been given by **NELSON MOBILIER**.
9.3. The Client undertakes to request the express authorization from **NELSON MOBILIER** before it diffuses promotional materials regarding the Products.
9.4. **NELSON MOBILIER** may be lead to communicate to the Client some visuals of the Products (plans, drawings, photographs etc.). The Client undertakes to make a particularly respectful use of these visuals in agreement with the image of the **NELSON MOBILIER** brand.

X. LANGUAGE OF THE CONTRACT

The present STCS are a translated from the French language. Consequently, in the event of any contradiction between the French and the present English version of the STCS, the terms of the French version will prevail.

XI. GOVERNING LAW / COMPETENT JURISDICTION

11.1. It expressly agreed by the Parties that the present Standard Terms and Conditions of Sale and its related purchase orders are governed by French law.
11.2. Any dispute between **NELSON MOBILIER** and its Clients arising from the order of Products shall be settled under the exclusive jurisdiction of the Commercial Court of Lyon.

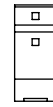
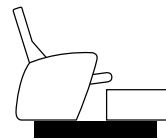
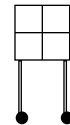
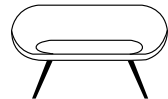
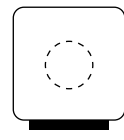
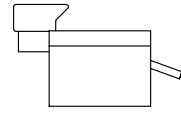
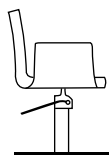
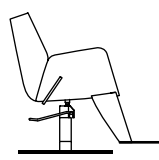
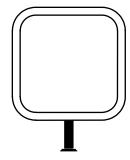

I. DISPOSICIONES GENERALES

- 1.1. Las presentes condiciones generales de venta (en adelante, las «CGV») se aplican a todas las ventas de mobiliario para peluquerías (en adelante, «los Producto(s)») por parte de la empresa NELSON MOBILIER (en adelante, «NELSON MOBILIER») con cualquier cliente que actúe en el marco de su actividad profesional (lo(s) «Cliente(s)»).
- 1.2. Estas CGV prevalecen sobre cualquier cláusula contraria en las Condiciones Generales de Compra del Cliente o en la nota de pedido. De hecho, las Condiciones Generales de Compra del Cliente en ningún caso tendrán prevalencia sobre estas CGV, estas últimas constituyen la base de la relación comercial entre NELSON MOBILIER y sus clientes, de conformidad con lo dispuesto en el artículo L.441-6 del Código de Comercio.
- 1.3. Estas CGV así como las condiciones tarifarias vinculadas con las mismas se envían sistemáticamente al Cliente. En consecuencia, la realización de un pedido implica la aceptación plena y sin reservas por parte del Cliente de estas CGV.
- 1.4. El hecho de que NELSON MOBILIER no haga valer, en un momento dado, cualquiera de las disposiciones de estas CGV no podrá interpretarse como una renuncia a poder hacerla valer posteriormente.

II. PEDIDOS

- 2.1. Los pedidos deben ser formalizados por escrito, por medio de una nota de pedido debidamente firmada por el Cliente y enviada a NELSON MOBILIER. Las ventas no serán perfectas hasta después de la aceptación expresa y por escrito del pedido por parte de NELSON MOBILIER.
- 2.2. No será posible la cancelación del pedido por parte del Cliente después de haber recibido la confirmación por escrito de NELSON MOBILIER.

III. TARIFAS

- 3.1. Los Productos se suministran por las tarifas que figuran en la lista de tarifas en vigor en la fecha de la realización del pedido y, en su caso, en la propuesta comercial específica enviada al Cliente. Estas tarifas son firmes y no revisables.
- 3.2. Los precios son netos y no incluyen el IVA. No incluyen el embalaje, el transporte, los posibles costes de aduana y los seguros, que corren a cargo del Cliente. El precio del embalaje se indica en la confirmación del pedido por parte de NELSON MOBILIER. Para entregas en Francia, el precio del transporte se integra en la factura y se calcula en función del pedido del Cliente
- 3.3. Se facturará una ecotasa de VALDELIA por la tarifa legal indicada en la factura.

IV. PAGO Y PENALIZACIONES POR DEMORA

- 4.1. Las facturas, incluidas las facturas de anticipo, son pagaderas a CHASSIEU, en la sede de la empresa NELSON MOBILIER, en el plazo máximo de 30 días a partir de la fecha de emisión de la factura.
- 4.2. En caso de demora en el pago de las cantidades debidas por el Cliente, el Cliente perderá cualquier derecho a los descuentos, rebajas o deducciones que le hubieran sido concedidos, y se aplicará una penalización por demora, calculada a tres veces el tipo de interés legal, que será debida automáticamente y de pleno derecho a NELSON MOBILIER, sin que se precise formalidad alguna ni requerimiento previo de pago, y sin perjuicio de cualquier otra acción que NELSON MOBILIER tendría derecho a entablar, por tal motivo, en contra del Cliente. Además, el Cliente tendrá que pagar una indemnización a tanto alzado por gastos de cobro establecida en 40 euros, de conformidad con el artículo D.441-5 del Código de Comercio.
- 4.3. Se acuerda expresamente que todas las cantidades debidas a NELSON MOBILIER, en virtud de cualquier contrato con el Cliente, en capital, intereses, gastos y accesorios, serán exigibles inmediatamente a causa de la falta de pago, a su vencimiento, de cualquiera de las cantidades debidas por el Cliente, o de cualquier incumplimiento por parte de este de las presentes CGV; llegado el caso, NELSON MOBILIER podrá requerir el pago de todas las cantidades debidas 30 días después de una simple notificación por correo certificado con acuse de recibo dirigida al Cliente y en la que se mencione la intención de aplicar esta cláusula, sin que sea necesaria ninguna otra formalidad para constatar la pérdida del derecho a redimir la deuda. Los pagos o regularizaciones posteriores a esta notificación no impedirán la exigibilidad anticipada de todas las cantidades debidas.
- 4.4. NELSON MOBILIER se reserva además el derecho de suspender o cancelar el envío de los pedidos futuros o en curso por parte del Cliente, sin perjuicio de las compensaciones e intereses que pudieran ser debidos.

V. RESERVA DE PROPIEDAD Y TRANSFERENCIA DE RIESGOS

- 5.1. **La propiedad de los Productos no será transferida al Cliente hasta que se haya producido el pago íntegro del precio y de sus accesorios e intereses de demora, reservándose NELSON MOBILIER hasta entonces el derecho de recobrar la posesión de dichos Productos. En su caso, cualquier anticipo pagado por el Cliente quedará en poder de NELSON MOBILIER como compensación a tanto alzado, sin perjuicio de cualquier otra acción que nuestra empresa tendría derecho a entablar por este hecho en contra del Cliente. El pago íntegro se entiende a partir del cobro efectivo de las letras de cambio y efectos comerciales o cheques.**

El Cliente se compromete a no vender o constituir una garantía sobre los Productos sujetos a la reserva de propiedad, bajo pena de rescisión del pedido.

El Cliente autoriza a partir de ahora y en adelante a NELSON MOBILIER a entrar en sus locales, talleres, comercios, oficinas u otros para proceder a la recuperación del o de los Productos vendidos y no pagados en la fecha de vencimiento acordada, y esto desde el día siguiente al de dicho vencimiento. Todos los gastos correspondientes correrán por cuenta del deudor moroso.

- 5.2. **En cambio, los riesgos se transfieren al Cliente desde el momento del envío de los Productos, es decir, desde su salida de los almacenes de NELSON MOBILIER. Por lo tanto, el Cliente se compromete a contratar cualquier seguro útil para protegerse contra cualquier riesgo al que puedan estar expuestos o causar los Productos durante el transporte y durante su instalación.**

VI. ENTREGA

- 6.1. Para los envíos fuera de Francia, los Productos se entregan en fábrica (o EXW).
- 6.2. Todos nuestros Productos viajan siempre con los gastos, riesgos y peligros por cuenta del destinatario: es por tanto responsabilidad del Cliente, en caso de daños, pérdida o retraso en la entrega, ejercer cualquier recurso contra el transportista y, de conformidad con el artículo L133-3 del Código de Comercio, efectuar todas las reservas necesarias al transportista por correo certificado con acuse de recibo dentro de las 72 horas (excepto días festivos) a partir de la recepción de los Productos, de las cuales se enviará simultáneamente una copia a NELSON MOBILIER. De lo contrario, dichos Productos se considerarán aceptados por el Cliente.
- 6.3. Una entrega parcial y/o un retraso en la entrega no darán al Cliente el derecho ni a cancelar el pedido, ni a rechazar los Productos, ni incluso a reclamar daños y perjuicios. Los plazos de entrega son solo a título informativo e indicativo, y cualquier retraso en la entrega no podrá dar lugar a ninguna sanción o indemnización, ni motivar la cancelación del pedido.

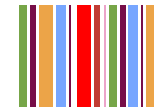
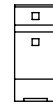
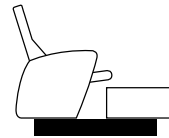
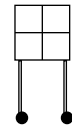
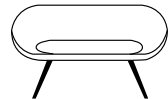
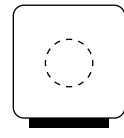
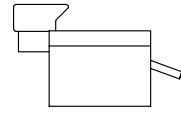
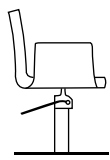
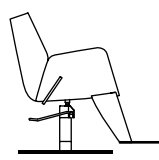
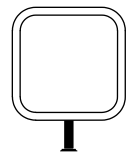

VII. GARANTÍA / RESPONSABILIDAD

7.1. Nuestra garantía se limita a la garantía legal contra los vicios o defectos ocultos que hacen que los Productos no sean aptos para su uso, y esto por dos años a partir de la fecha de compra. Esta garantía se limita a la sustitución de los Productos afectados por un defecto. Es responsabilidad del Cliente demostrar la existencia del defecto.

La garantía está excluida en caso de mala utilización, negligencia o falta de mantenimiento por parte del Cliente, como en el caso del uso y desgaste normal de dicho bien o de fuerza mayor.

Para hacer valer sus derechos, el Cliente deberá, bajo pena de pérdida del derecho a ejercer de cualquier acción relacionada, informar por escrito a **NELSON MOBILIER** de la existencia de defectos en un plazo máximo de 3 días a partir de su descubrimiento.

NELSON MOBILIER sustituirá o reparará los Productos o piezas en garantía considerados defectuosos. A la expiración de este período de 2 años, la sustitución y el precio de cualquier pieza de repuesto serán a cargo del Cliente.

7.2. En cualquier caso, no se podrá realizar ninguna reclamación relacionada con:

- La porosidad de algunos componentes (bases, reposabrazos), la cual resulta de los moldes utilizados en su fabricación,
- Las manchas, suciedad en los revestimientos, en cuanto ningún revestimiento de piel sintética es resistente a las manchas. Estas deben limpiarse únicamente con agua tibia y jabón,
- Los matices de colores de los componentes, ya que pueden verse modificados debido a la exposición a la luz, y para los materiales de aglomerado, barnices, madera, es imposible encontrar matices de colores idénticos,
- Las formas y los colores, etc. de los mosaicos, que son piezas de arte únicas hechas a mano y que competen al ámbito del maestro artesano vidriero,
- Los ruidos relativos al funcionamiento de los sistemas de masaje,

La altura de las sillas, de carácter exclusivamente indicativo, y que varía en función de la base seleccionada. La altura de las sillas se establece de modo que el asiento esté a 48 cm del suelo (mínimo 46, máximo 51) en función de la base seleccionada.

El Cliente reconoce tener conocimiento de las siguientes recomendaciones de uso de los Productos:

- No utilizar productos abrasivos para la limpieza de los elementos de aluminio,
- Utilizar solamente agua tibia y jabón para limpiar los revestimientos,
- Las sillas pueden ir tapizadas con los revestimientos del cliente. En este caso, no se concederá ninguna rebaja en el precio y nuestra empresa no podrá ofrecer una garantía equivalente a la de los modelos estándar. NELSON MOBILIER no acepta colores del Cliente para reproducir en nuestras maderas u otros materiales,

No levantar las sillas por los reposabrazos: esto puede provocar que entre aire en la bomba. Dado el caso, volver a colocar la bomba en su posición original y accionar el pedal varias veces para expulsar el aire.

7.3. **NELSON MOBILIER** solo está obligado a reparar los daños materiales directos causados al Cliente y que sean el resultado de faltas imputables a **NELSON MOBILIER** en la ejecución del contrato. En ningún caso se podrá hacer responsable a **NELSON MOBILIER** por un importe superior al importe del pedido en cuestión.

VIII. FUERZA MAYOR

8.1. **NELSON MOBILIER** no podrá ser considerado responsable con respecto al Cliente de la no ejecución o de los retrasos en la ejecución de una obligación surgida de estas CGV como consecuencia de la aparición un caso de fuerza mayor reconocido por la jurisprudencia francesa.

8.2. El caso de fuerza mayor suspende las obligaciones surgidas de estas CGV durante toda su existencia.

IX. PROPIEDAD INTELECTUAL / DERECHOS DE IMAGEN

9.1. **NELSON MOBILIER** es el titular de todos los derechos de propiedad intelectual sobre los Productos que comercializa. La venta de los Productos no confiere ninguna prerrogativa al Cliente sobre los derechos de propiedad intelectual que ostenta **NELSON MOBILIER**.

9.2. En consecuencia, el Cliente se compromete a utilizar las marcas con el único propósito de promover y revender los Productos, con exclusión de cualquier otro uso, y solo con el consentimiento previo por escrito de **NELSON MOBILIER**.

9.3. El Cliente se compromete a solicitar la autorización expresa de **NELSON MOBILIER** antes de distribuir material promocional en relación con los Productos.

9.4. **NELSON MOBILIER** puede verse forzado a transmitir al Cliente imágenes de los Productos (planos, diseños, fotografías, etc.). El Cliente se compromete a hacer un uso especialmente respetuoso de estas imágenes, en consonancia con la imagen de marca de **NELSON MOBILIER**. En ningún caso este derecho de uso lleva aparejado para el Cliente el derecho a modificar o adaptar estas imágenes sin el consentimiento previo por escrito de **NELSON MOBILIER**.

X. IDIOMA DEL CONTRATO

Las presentes CGV están redactadas en francés. En caso de que se traduzcan a uno o varios idiomas, solamente el texto francés prevalecerá en caso de litigio.

XI. DERECHO APLICABLE / JURISDICCIÓN

11.1. Por acuerdo expreso entre las Partes, las presentes Condiciones Generales de Venta y los pedidos que se realicen bajo las mismas se rigen por la legislación francesa.

11.2. Cualquier litigio que surja entre **NELSON MOBILIER** y sus Clientes con motivo del pedido de Productos será sometido exclusivamente al Tribunal de Comercio de LYON.

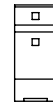
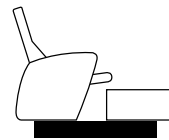
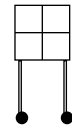
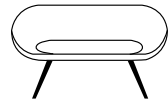
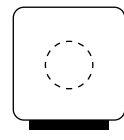
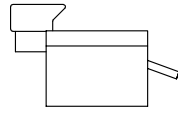
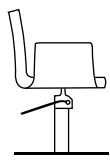
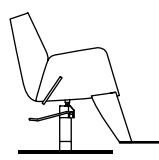
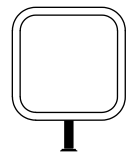

I. ALLGEMEINE BESTIMMUNGEN

- 1.1. Diese Allgemeinen Verkaufsbedingungen (im Folgenden „AGB“) gelten für alle Verkäufe von Möbeln für Friseursalons (im Folgenden „das/die Produkt (e)“) durch das Unternehmen NELSON MOBILIER (im Folgenden „NELSON MOBILIER“) mit jedem im Rahmen seiner beruflichen Tätigkeit handelnden Kunden („der/die Kunde(n)“ genannt).
- 1.2. Diese AGB haben Vorrang vor allen anderslautenden Klauseln in den Allgemeinen Einkaufsbedingungen des Kunden oder auf dem Bestellformular. Die Allgemeinen Einkaufsbedingungen des Kunden können in der Tat in keinem Fall Vorrang haben vor diesen AGB, da letztere die Basis der Geschäftsbeziehung zwischen NELSON MOBILIER und seine Kunden in Übereinstimmung mit den Bestimmungen des Artikels L.441-6 des HGB bilden.
- 1.3. Diese AGB sowie die sich darauf beziehenden Preisbedingungen werden automatisch an den Kunden gesendet. Folglich impliziert die Erteilung einer Bestellung die volle und vorbehaltlose Annahme dieser AGB seitens des Kunden.
- 1.4. Die Tatsache, dass NELSON MOBILIER zu einem bestimmten Zeitpunkt hinsichtlich irgendeiner Bestimmung dieser AGB sein Vorrecht nicht geltend macht, darf nicht als Verzicht auf eine zukünftige Geltendmachung dieser ausgelegt werden.

II. BESTELLUNGEN

- 2.1. Bestellungen müssen schriftlich auf einem vom Kunden ordnungsgemäß unterzeichneten Bestellschein ausgeführt und an NELSON MOBILIER gesandt werden. Die Verkäufe werden erst nach ausdrücklicher und schriftlicher Annahme der Bestellung durch NELSON MOBILIER ausgeführt.
- 2.2. Eine Stornierung der Bestellung durch den Kunden nach Eingang der schriftlichen Bestätigung von NELSON MOBILIER ist nicht mehr möglich.

III. PREISE

- 3.1. Die Produkte werden zu den Preisen der zum Zeitpunkt der Bestellung gültigen Preisliste geliefert und, gegebenenfalls, gemäß dem an den Kunden gesandten spezifischen kommerziellen Angebot. Diese Preise sind fest und nicht veränderbar.
- 3.2. Die Preise verstehen sich netto und ohne Steuern. Sie beinhalten keine Verpackung, Transport, etwaige Zollgebühren und Versicherungen, die zu Lasten des Kunden gehen. Der Preis der Verpackung ist in der Bestätigung der Bestellung von NELSON MOBILIER angegeben. Bei Lieferungen in Frankreich ist der Preis für den Transport auf der Rechnung integriert und je nach Kundenbestellung kalkuliert.
- 3.3. Ein Öko-Beitrag VALDELIA wird in der gesetzlichen Höhe berechnet und auf der Rechnung angegeben.

IV. BEZAHLUNG UND VERZUGSSTRAFEN

- 4.1. Rechnungen, einschließlich der Anzahlungsrechnungen, sind in CHASSIEU am Sitz der Gesellschaft NELSON MOBILIER innerhalb von maximal 30 Tagen ab Ausstelldatum der Rechnung zahlbar.
- 4.2. Im Falle einer verspäteten Zahlung der fälligen Beträge durch den Kunden, verliert der Kunde ein Recht auf Preisnachlässe, Rabatte, Skonti, die ihm gewährt wurden, und es werden Verzugsstrafen, zum Dreifachen des gesetzlichen Zinssatzes berechnet, von NELSON MOBILIER automatisch und rechtmäßig ohne vorherige Ankündigung oder Formalität und ungeachtet jeglicher sonstigen Maßnahmen erhoben, die NELSON MOBILIER berechnen würde, hierzu gegenüber dem Kunden zu ergreifen. Darüber hinaus hat der Kunde eine pauschale Entschädigung für Beitreibungskosten in Höhe von 40 Euro gemäß Artikel D.441-5 des HGB zu entrichten.
- 4.3. Es wird ausdrücklich vereinbart, dass alle Gelder, die NELSON MOBILIER aufgrund jedes Vertrages mit dem Kunden geschuldet werden wie Nennbetrag, Zinsen, Kosten und Zubehör, sofort infolge der Nichtbezahlung von irgendeinem der vom Kunden geschuldeten Beträge bei Fälligkeit zahlbar werden, oder bei jeglichem Verstoß durch diesen gegen die AGB; gegebenenfalls kann NELSON MOBILIER die Zahlung aller ihm geschuldeten Beträge verlangen, und dies 30 Tage nach einfacher Benachrichtigung per Einschreiben mit Rückschein an den Kunden unter Hinweis auf die Absicht, diese Klausel anzuwenden, ohne dass keine weiteren Formalitäten zur Bestätigung des Verzugsfalls erforderlich sind. Zahlungen oder Begleichungen nach dieser Mitteilung werden diese vorgezogene Fälligkeit nicht beschränken.
- 4.4. NELSON MOBILIER behält sich ferner das Recht vor, die Auslieferung der laufenden oder zukünftigen Bestellung des Kunden auszusetzen oder zu annullieren ungeachtet des Schadenersatzes, der ihm geschuldet werden könnte.

V. EIGENTUMSVORBEHALT UND GEFAHRENÜBERGANG

- 5.1. **Das Eigentum an den Produkten geht an den Kunden nur nach Zahlung des Gesamtpreises und der Nebenkosten und Zinsen über, wobei NELSON MOBILIER sich das Recht vorbehält, bis dahin die betreffenden Produkte wieder in Besitz nehmen. Gegebenenfalls wird jede durch den Kunden getätigte Anzahlung von NELSON MOBILIER als pauschale Entschädigung betrachtet, unbeschadet aller anderen Maßnahmen, die unser Unternehmen berechnen würde, aufgrund dessen gegenüber dem Kunden geltend zu machen. Unter vollständiger Zahlung ist der tatsächliche Zahlungseingang der Wechsel, Handelspapiere, oder Schecks zu verstehen.**
Dem Kunden ist ein Verkauf oder die Verpfändung der dem Eigentumsvorbehalt unterliegenden Erzeugnisse unter Androhung der Annullierung der Bestellung untersagt.
Der Kunde genehmigt bereits jetzt NELSON MOBILIER den Zutritt zu den Räumlichkeiten, Werkstätten, Läden, Büros oder Sonstigem, um das/ oder die verkauften, zum vereinbarten Fälligkeitsdatum nicht bezahlte(n) Produkt(e) zurückzunehmen, und dies ab dem auf die Fälligkeit folgenden Tag. Alle damit verbundenen Kosten sind von dem säumigen Schuldner zu tragen.
- 5.2. **Im Gegenzug gehen die Risiken auf den Kunden ab Versand der Produkte über, d.h. ab Ausgang Lagerhallen von NELSON MOBILIER. Infolgedessen verpflichtet sich der Kunde eine entsprechende Versicherung abzuschließen, um sich gegen alle Risiken zu schützen, denen die Produkte während des Transports ausgesetzt sind oder die bei ihrer Installation auftreten können.**

VI. LIEFERUNG

- 6.1. Bei Lieferungen außerhalb Frankreichs werden die Produkte ab Werk (oder EXW) geliefert.
- 6.2. Unsere Produkte werden immer auf Kosten und Gefahr des Empfängers befördert: Es obliegt daher dem Kunden, im Falle einer Beschädigung, Verlust oder Lieferverzug alle Regressansprüche gegenüber dem Transporteur und in Übereinstimmung mit Artikel L133-3 des HGB geltend zu machen, alle notwendigen Angaben dem Transporteur per Einschreiben mit Rückschein innerhalb von 72 Stunden (außer an Feiertagen) ab Erhalt der Produkte zu übermitteln, von dem eine Kopie gleichzeitig NELSON MOBILIER zu übermitteln ist. Andernfalls werden solche Produkte als vom Kunden akzeptiert angesehen.
- 6.3. Eine Teillieferung und / oder verspätete Lieferung berechtigt den Kunden nicht, die Bestellung zu stornieren, noch die Produkte zu verweigern oder sogar Schadenersatz zu verlangen.
Die Lieferzeiten sind nur zur Information und zur Orientierung angegeben und jede Verzögerung bei der Lieferung kann nicht zu einer Vertragsstrafe oder Entschädigung berechnen oder die Stornierung der Bestellung begründen.

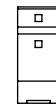
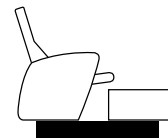
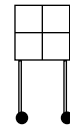
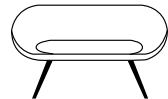
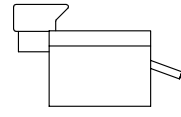
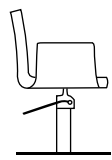
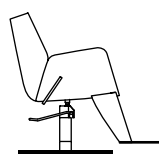
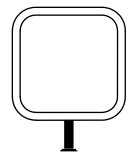

VII. GARANTIE / HAFTUNG

7.1. Unsere Garantie ist auf die gesetzliche Garantie gegen versteckte Mängel beschränkt, die die Produkte für den Gebrauch ungeeignet machen, und das für zwei Jahre ab Kaufdatum. Diese Garantie ist auf Ersatz der mit einem Mangel behafteten Produkte beschränkt. Es obliegt dem Kunden, das Vorliegen des Mangels zu beweisen.

Jede Gewährleistung ist bei unsachgemäßer Behandlung, Vernachlässigung oder mangelnder Pflege durch den Kunden sowie im Fall von normalem Verschleiß oder höhere Gewalt ausgeschlossen.

Zur Geltendmachung seiner Rechte muss der Kunde bei Gefahr der Verwirkung seiner Rechtsansprüche **NELSON MOBILIER** schriftlich über das Vorhandensein von Mängeln binnen einer Frist von maximal 3 Tagen nach ihrer Entdeckung informieren.

NELSON MOBILIER ersetzt oder lässt die als defekt beurteilten Produkte oder Teile, die unter Garantie stehen, reparieren. Nach Ablauf dieses Zeitraums von 2 Jahren, gehen der Ersatz und der Preis aller Ersatzteile zu Lasten des Kunden.

7.2. In jeden Fall kann eine Reklamation nicht erhoben werden für:

- Die Porosität bestimmter Komponenten (Sockelgestelle, Armlehnen), die von den für die Herstellung verwendeten Formen herrührt,
- Flecken, Schmutz auf den Bezügen, da kein Bezug aus Lederimitat schmutzabweisend ist. Diese sollten nur mit warmem Wasser und Seife gereinigt werden,
- Die Farbtöne der Komponenten, da sie durch die Einwirkung von Licht verändert werden können, und für Verbundmaterialien, Lacke, Holz, für die es unmöglich ist, identische Farbnuancen wieder zu finden,
- Die Formen und Farben usw. der Mosaiken, die kunsthandwerkliche Unikate sind und deren Auswahl der Kunstglasermeister trifft,
- Lärmgeräusch beim Betrieb der Massagesysteme,

Die Höhe der Sitze, die nur zur Information angegeben ist und die je nach gewählter Basis variiert. Die Höhe der Sitze ist so eingestellt, dass die Höhe des Sitzes 48 cm vom Boden (min. 46, max. 51) beträgt in Abhängigkeit von der gewählten Basis.

Der Kunde erkennt an, die Empfehlungen für den Gebrauch der folgenden Produkte zur Kenntnis genommen zu haben:

- Keine Schleifmittel für die Reinigung der Aluminiemelemente zu verwenden.
- Nur warmes Wasser und Seife für die Reinigung der Bezüge zu verwenden.
- Die Sessel können mit Kundenbezügen überzogen werden. In derartigem Fall wird kein Preisnachlass gewährt und unser Unternehmen wird keine Garantie wie für gleichwertige Standard-Modelle bieten. NELSON MOBI akzeptiert keine Reproduktion von Kundenfarben auf unser Holz oder andere Materialien,

Die Stühle nicht an den Armlehnen hochheben: Dies kann zu einem Lufteintritt in die Pumpe führen. Gegebenenfalls ist die Pumpe in ihre ursprüngliche Position zu bringen und das Pedal mehrmals zu betätigen, um die Luft entweichen zu lassen.

7.3. **NELSON MOBILIER** ist verpflichtet, nur die direkt beim Kunden verursachten Materialschäden zu reparieren und die aus Fehlern resultieren, die unstrittig **auf NELSON MOBILIER** bei der Durchführung des Vertrages zurückzuführen sind. In keinem Fall wird die Haftung von **NELSON MOBILIER** eine Höhe betragen, die über dem Betrag der betroffenen Bestellung liegt.

VIII. HÖHERE GEWALT

8.1. **NELSON MOBILIER** kann gegenüber dem Kunden nicht haftbar gemacht werden für die Nichtausführung oder Verzögerungen bei der Erfüllung einer Verpflichtung aus diesen Allgemeinen Verkaufsbedingungen im Anschluss an das Auftreten eines Falls höherer Gewalt, der als solcher durch die Französischen Gerichte anerkannt wurde.

8.2. Die höhere Gewalt unterbricht die Verpflichtungen aus diesen AGB für die gesamte Dauer ihres Bestehens.

IX. GEISTIGES EIGENTUM / RECHTE AN BILDMATERIAL

9.1. **NELSON MOBILIER** hält alle Rechte an geistigem Eigentum auf Produkte, die es verkauft. Der Verkauf der Produkte verleiht dem Kunden keine Befugnis an den geistigen Eigentumsrechten, die von **NELSON MOBILIER** gehalten werden.

9.2. Demzufolge verpflichtet sich der Kunde, die Marken nur zu dem alleinigen Zweck zu verwenden, die Produkte zu bewerben und weiterzuverkaufen unter Ausschluss jeder anderen Nutzung und nur bei vorheriger schriftlicher Zustimmung von **NELSON MOBILIER**.

9.3. Der Kunde verpflichtet sich, die ausdrückliche Zustimmung von **NELSON MOBILIER** vor der Verbreitung von Werbematerialien für die Produkte einzuholen.

9.4 **Für NELSON MOBILIER** kann es erforderlich sein, dem Kunden Bildmaterial für Produkten (Pläne, Zeichnungen, Fotografien usw.) zu übergeben. Der Kunde verpflichtet sich zu besonders respektvollem Umgang mit diesem Bildmaterial im Einklang mit dem Markenimage von **NELSON MOBILIER**. Auf keinen Fall räumt dieses Nutzungsrecht dem Kunden das Recht ein, dieses Bildmaterial ohne die vorherige schriftliche Zustimmung von **NELSON MOBILIER** zu ändern oder anzupassen.

X. VERTRAGSSPRACHE

Diese AGB sind in französischer Sprache verfasst. Für den Fall ihrer Übersetzung in eine oder mehrere Sprachen ist im Streitfall nur der französische Text maßgebend.

XI. GELTENDES RECHT / GERICHTSSTAND

11.1. Gemäß ausdrücklicher Vereinbarung zwischen den Parteien unterliegen diese Allgemeinen Geschäftsbedingungen und die daraus hervorgehenden Bestellungen französischem Recht.

11.2. Alle Streitigkeiten zwischen **NELSON MOBILIER** und seinen Kunden bezüglich der Bestellung von Produkten werden ausschließlich beim Handelsgericht Lyon eingereicht.